

Philips Sensor
LEDtube 1200mm



PHILIPS



Philips Sensor LEDtube is a reliable value-for-money LED lamp out of Philips lighting portfolio, incorporated with frontier LED chips and other advanced technologies. The product helps customers to achieve over 60% energy saving and significant maintenance cost reduction by comparing to fluorescent lamps. It also helps generate natural and comfortable lighting effect, and to build up green and environment friendly image for our customers.

Product Features

New Platform

- First corepro LEDtube with glass tube to inherent Philip's strong & solid fluorescent technology with unique glass coating
- Wider beam angle for diffuse light effect in basic type of luminaires like bare batten or closed luminaires
- Enhanced efficiency (from 110 to 115 lm/w)

Sensor Technology

- Unique Micro-Wave based Sensor Chip.
- Operational under temperature variations.

Maintain high performance

- Reliable operation between -20 °C to 45 °C ambient temperature
- Trustable claimed lifetime
- 50,000 switching cycles

User Comfort

- CRI 80
- Instant on, no flicker or buzz
- Advanced optical design ensures a uniform light output and superior optical efficiency

Energy Efficient

- Energy savings over 60%* @ FULL ON mode
- Energy savings over 90%* @ DIM mode

* Based on comparison between 16W Corepro LEDtube standard and Philips TLD standard or super 80 36W (40-44W system power when working with Electro Magnetic Ballasts)

Safety

- Protection circuit inside ensuring people's safety in case of mis-use, complying with IEC safety requirements
- Pass 4KV high-pot test, insulation & safety guaranteed
- Pass 1KV surge test (vs. IEC standard 500V), avoiding the damage caused by input voltage fluctuation and lightning strike
- 100% comply with IEC requirement on T8 dimension, fitting into fluorescent luminaire perfectly

Environmental Friendly

- No mercury
- No pollution risk

Application

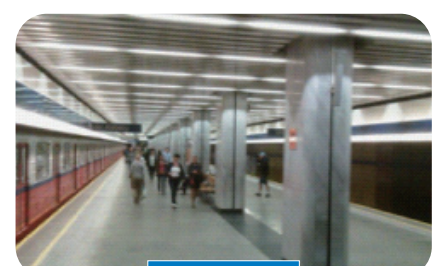
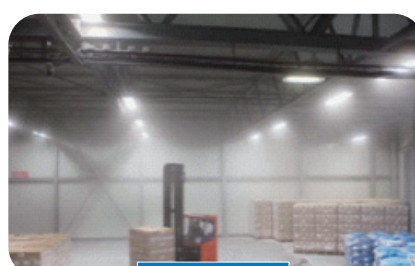
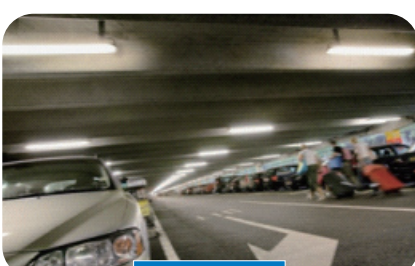
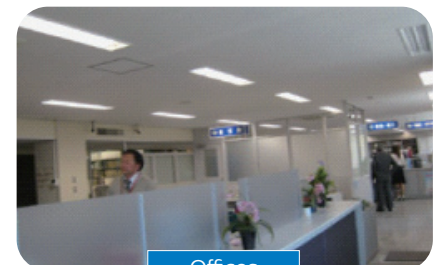
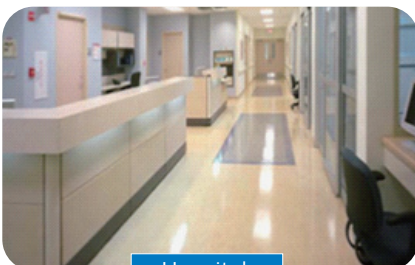
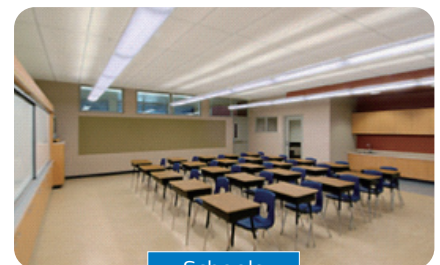
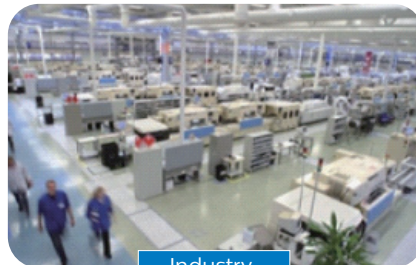
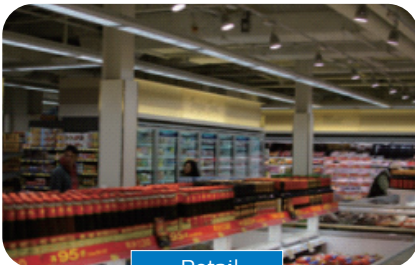

Spectral Power Distribution

Light may be precisely characterized by giving the power of the light at each wavelength in the visible spectrum. The resulting spectral power distribution (SPD) shows that the Sensor LEDtube contains the visible light only. No harm from UV and IR.

1200mm

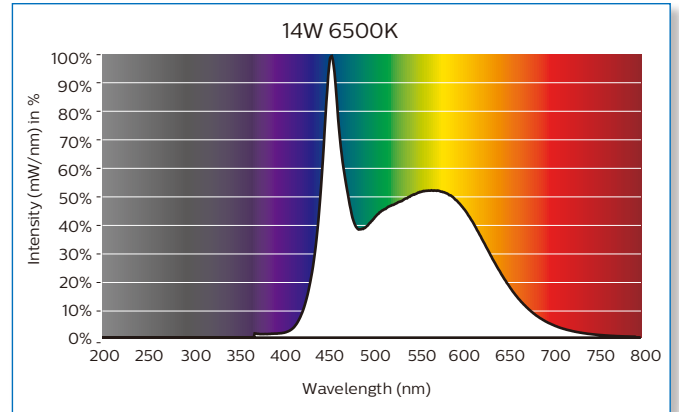
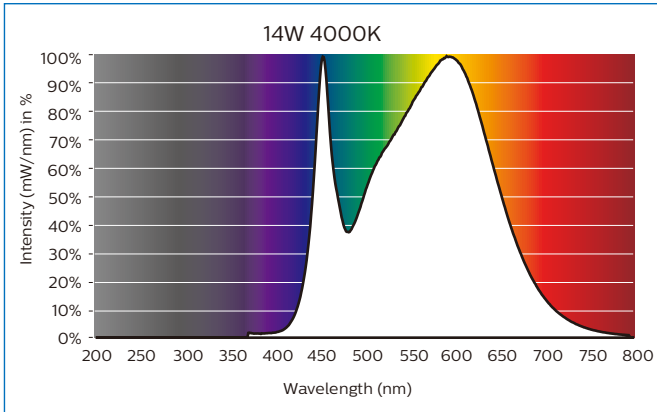

Photometric Diagrams

The Photometric diagram depicting the top down mounted lighting fixtures in a specific area and a numerical grid of the maintained lighting levels that the fixture will produce in that specific area. Pictures below show the photometric diagrams of a typical Philips Sensor LEDtube's application.

Sensor LEDtube 1200mm 1600lm 14W840

1 x 1600 lm

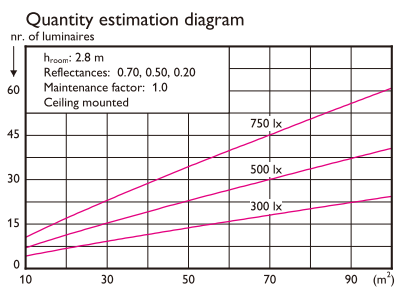
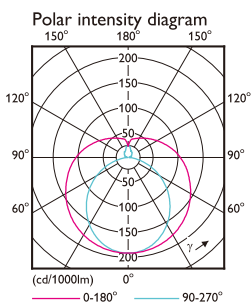

Utilisation factor table

Room Index k	Reflectances (%) for ceiling, walls and working plane (CIE)																	
	0.80	0.80	0.70	0.70	0.70	0.70	0.50	0.50	0.30	0.30	0.00	0.50	0.50	0.30	0.10	0.10	0.00	0.00
0.60	0.40	0.38	0.38	0.37	0.36	0.29	0.27	0.22	0.25	0.21	0.17	0.60	0.50	0.50	0.50	0.30	0.10	0.00
0.80	0.50	0.47	0.47	0.46	0.44	0.37	0.34	0.29	0.31	0.27	0.22	0.80	0.70	0.70	0.70	0.50	0.30	0.10
1.00	0.58	0.53	0.54	0.53	0.51	0.43	0.40	0.35	0.36	0.32	0.27	1.00	0.90	0.90	0.90	0.70	0.50	0.30
1.25	0.65	0.60	0.62	0.59	0.57	0.50	0.46	0.41	0.42	0.38	0.31	1.50	1.40	1.40	1.40	1.10	0.90	0.70
1.50	0.72	0.65	0.67	0.65	0.62	0.55	0.50	0.45	0.46	0.42	0.35	2.00	1.80	1.80	1.80	1.50	1.30	1.10
2.00	0.81	0.72	0.76	0.72	0.69	0.63	0.57	0.53	0.52	0.49	0.41	2.50	2.30	2.30	2.30	1.90	1.70	1.50
2.50	0.87	0.77	0.82	0.78	0.74	0.68	0.62	0.58	0.57	0.54	0.46	3.00	2.80	2.80	2.80	2.40	2.20	2.00
3.00	0.92	0.81	0.86	0.81	0.77	0.72	0.66	0.62	0.60	0.57	0.49	4.00	3.80	3.80	3.80	3.40	3.20	3.00
4.00	0.98	0.85	0.92	0.86	0.81	0.77	0.71	0.67	0.65	0.62	0.53	5.00	4.80	4.80	4.80	4.40	4.20	4.00
5.00	1.02	0.88	0.96	0.90	0.84	0.80	0.74	0.71	0.68	0.65	0.56							

Luminance Table

Plane Cote	0.0	15.0	30.0	45.0	60.0	75.0	90.0
45.0	5495	5468	5447	5497	5709	6300	7671
50.0	5311	5269	5221	5238	5376	5902	7379
55.0	5150	5100	5022	4979	5040	5471	7030
60.0	5020	4962	4863	4765	4725	5031	6648
65.0	4911	4859	4728	4578	4434	4555	6150
70.0	4839	4789	4637	4441	4198	4074	5569
75.0	4821	4766	4602	4378	4019	3590	4802
80.0	4838	4777	4625	4362	3914	3130	3678
85.0	4876	4794	4658	4416	3899	2819	2103
90.0	4958	4875	4734	4500	4022	2845	1531

Sensor LEDtube 1200mm 1600lm 14W865

1 x 1600 lm

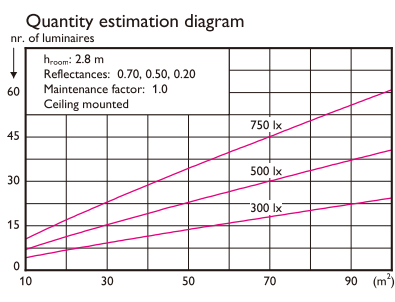
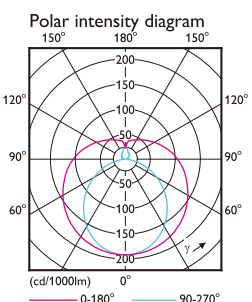

Utilisation factor table

Room Index k	Reflectances (%) for ceiling, walls and working plane (CIE)																	
	0.80	0.80	0.70	0.70	0.70	0.70	0.50	0.50	0.30	0.30	0.00	0.50	0.50	0.30	0.10	0.10	0.00	0.00
0.60	0.40	0.38	0.38	0.37	0.36	0.29	0.27	0.22	0.25	0.21	0.17	0.60	0.50	0.50	0.50	0.30	0.10	0.00
0.80	0.50	0.47	0.47	0.46	0.44	0.37	0.34	0.29	0.31	0.27	0.22	0.80	0.70	0.70	0.70	0.50	0.30	0.10
1.00	0.58	0.53	0.54	0.53	0.51	0.43	0.40	0.35	0.36	0.32	0.27	1.00	0.90	0.90	0.90	0.70	0.50	0.30
1.25	0.65	0.60	0.62	0.59	0.57	0.50	0.46	0.41	0.42	0.38	0.31	1.50	1.40	1.40	1.40	1.10	0.90	0.70
1.50	0.72	0.65	0.67	0.65	0.62	0.55	0.50	0.45	0.46	0.42	0.35	2.00	1.80	1.80	1.80	1.50	1.30	1.10
2.00	0.81	0.72	0.76	0.72	0.69	0.63	0.57	0.53	0.52	0.49	0.41	2.50	2.30	2.30	2.30	1.90	1.70	1.50
2.50	0.87	0.77	0.82	0.78	0.74	0.68	0.62	0.58	0.57	0.54	0.46	3.00	2.80	2.80	2.80	2.40	2.20	2.00
3.00	0.92	0.81	0.86	0.81	0.77	0.72	0.66	0.62	0.60	0.57	0.49	4.00	3.80	3.80	3.80	3.40	3.20	3.00
4.00	0.98	0.85	0.92	0.86	0.81	0.77	0.71	0.67	0.65	0.62	0.53	5.00	4.80	4.80	4.80	4.40	4.20	4.00
5.00	1.02	0.88	0.96	0.90	0.84	0.80	0.74	0.71	0.68	0.65	0.56							

Luminance Table

Plane Cote	0.0	15.0	30.0	45.0	60.0	75.0	90.0
45.0	5495	5468	5447	5497	5709	6300	7671
50.0	5311	5269	5221	5238	5376	5902	7379
55.0	5150	5100	5022	4979	5040	5471	7030
60.0	5020	4962	4863	4765	4725	5031	6648
65.0	4911	4859	4728	4578	4434	4555	6150
70.0	4839	4789	4637	4441	4198	4074	5569
75.0	4821	4766	4602	4378	4019	3590	4802
80.0	4838	4777	4625	4362	3914	3130	3678
85.0	4876	4794	4658	4416	3899	2819	2103
90.0	4958	4875	4734	4500	4022	2845	1531

Lifetime and Lumen Maintenance

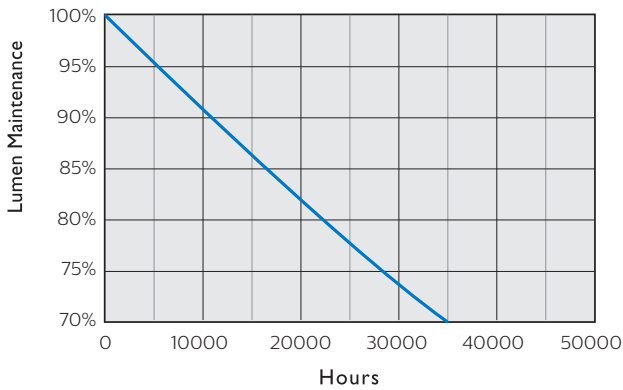

Philips Sensor LEDtube has a lifetime of 30,000 hours, defined as the number of hours when 50% of a large group of identical lamps below 70% of its initial lumens.

Temperature

Sensor LEDtube's excellent thermal design ensures low temperature during operating, which brings reliable and stable product performance throughout life time.

Operating temperature	$T_{operating}$	min -20°C	max +45°C
Storage temperature	T_{case}	min -40°C	max +65°C
Maximum surface temperature for rated lifetime of tube at $T_{amb.}=25^{\circ}C$	T_{case}		+56°C

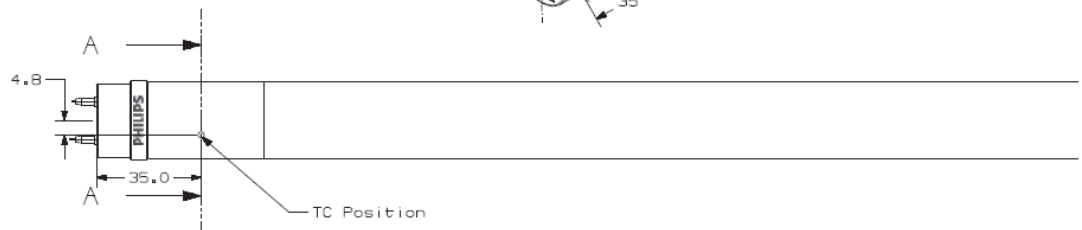
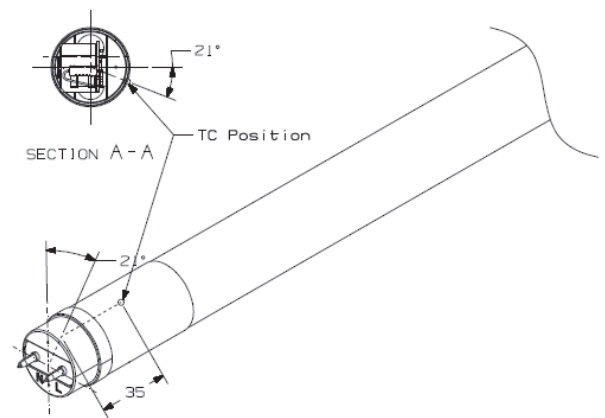
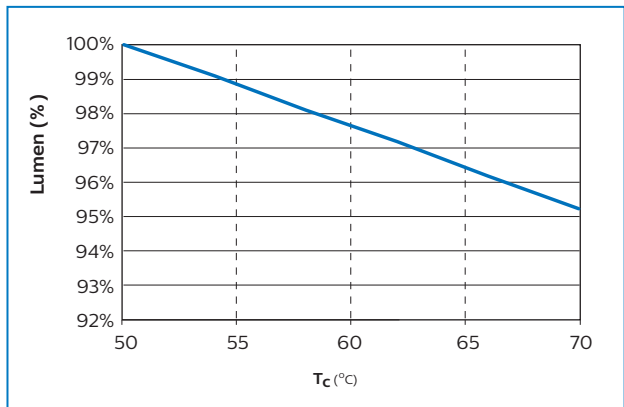

Approbation & Certificates

Philips LEDtube is designed by strictly following applicable legislation and international standard. The product complies with **CE, KEMA, RoHS and REACH**.



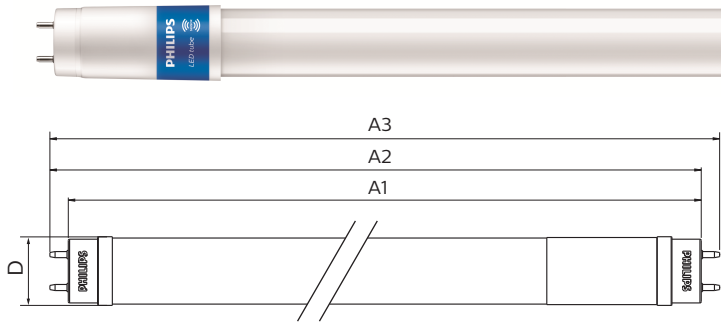

Dimensions (mm)

Product	A1	A2	A3	D
1200mm	1198	1205	1212	28

Technical specification

Product Description	Lamp Wattage (W)	Voltage (V)	Cap	Length (mm)	Beam Angle (°)	Lifetime (hrs)	Lumen output (lm)	CCT (K)	CRI * (Typical)	Pcs per	Model Number Box
Sensor LEDtube 1200mm 1600lm 14W840	14	100-240	G13	1200	240	30,000	1600	4000	80	10	9290018192
Sensor LEDtube 1200mm 1600lm 14W865	14	200-240	G13	1200	240	30,000	1600	6500	80	10	9290018193

* minimum is 80

Technical details:

- Working Frequency Band - **5.8G±75MHz**
- Detection Range - **5m radius@2.5m height**
- Time delay to 100% light output - **60 seconds**
- DIM Mode wattage - **3.0 Watts**

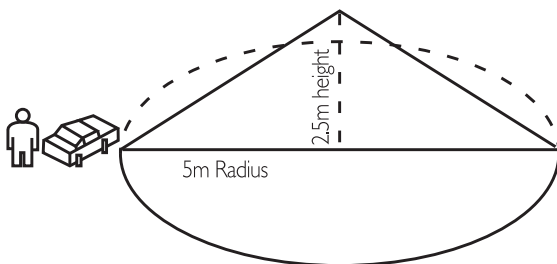

Sensing range: 5m radius in luminaire with PC cover
 Standby: 20% light level
 Hold time: 60 seconds

Quick Installation Guide

Please take the time to read this quick installation guide. Philips Lighting does not accept liability for any damages for installations not performed according to this guide or not performed by a professional electrician.

Installation Guide

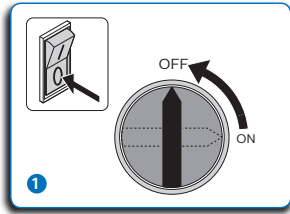

Mains Off

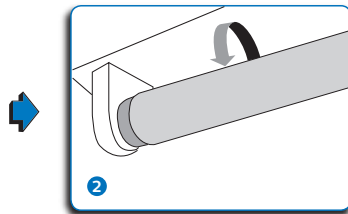

Remove all existing FLUORESCENT TUBES from luminaire

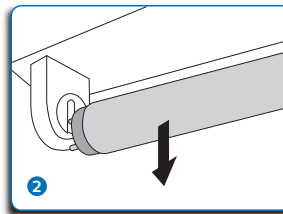

For 3 lamps use diagram A & B

For 4 lamps use diagram B & B

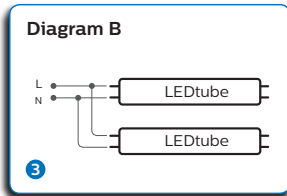
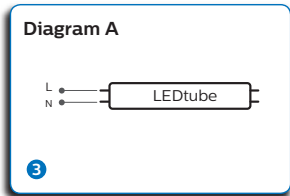

The supplied warning sticker must be placed on the luminaire and must be visible during lamp replacement

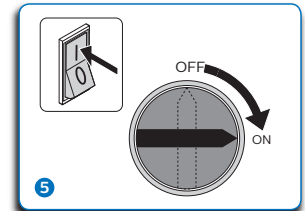

Turn on mains

Bypass existing BALLAST and rewire according to the following diagrams. Please check the L/N markings on the lamp end and insert the lamp with AC mains supplied to the corresponding end. To install the lamp in the wrong direction will lead to malfunction.



OEM Guideline

Lifetime Curve

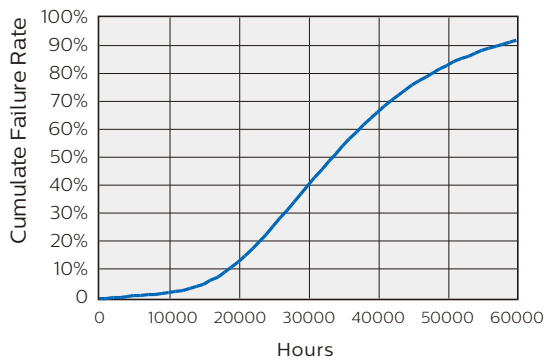

Lifetime and Lumen Maintenance

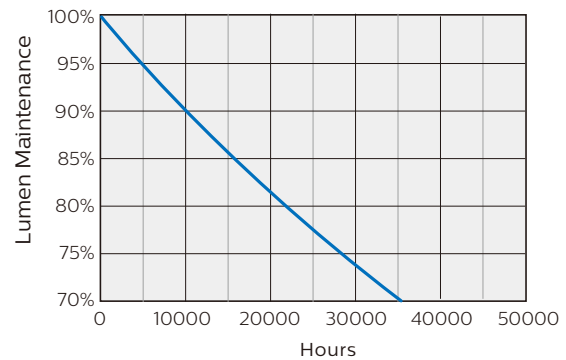

Failure Rate vs. Lifetime vs. Tcase

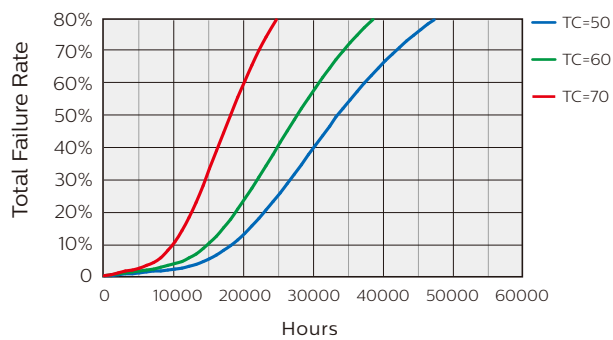

Lifetime vs. Tcase

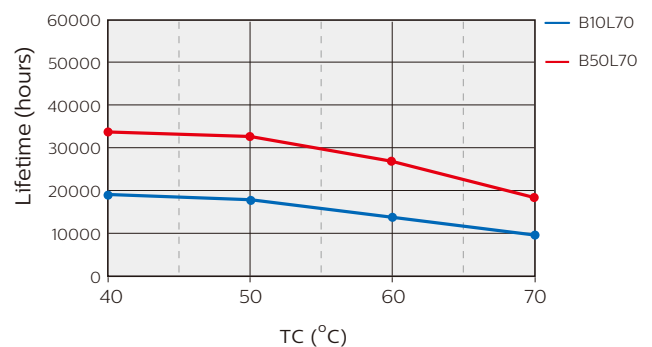

© 2017 Philips Lighting

All rights reserved. Reproduction in whole or in part is prohibited without the prior written consent of the copyright owner. The information presented in this document does not form part of any quotation or contract, is believed to be accurate and reliable and may be changed without notice. No liability will be accepted by the publisher for any consequence of its use. Publication thereof does not convey nor imply any license under patent or other industrial or intellectual property rights.

07/2017

www.philips.com