

PV panel Replacement-UrbanSpark

The battery presents a risk of electrical shock and a high short circuit current. The Philips mounting instructions must be strictly followed, otherwise potential application, reliability or safety issues may arise. Only a qualified Philips service representative who is knowledgeable in product and the required precautions is permitted to replacement. Keep unauthorized person away from the product during the replacement. The deviation from standard instructions may causes abnormal system operations or even dangerous situations.

Tools:



Spanner



Flat screwdriver



Allen wrench



Cross screwdriver



Multi-meter



Glass sucker(optional)

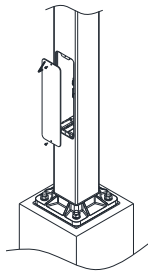

1. Open the
serve hatch

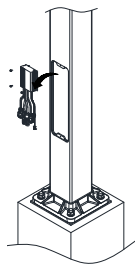

2. Disconnect all
cables and take
out the controller

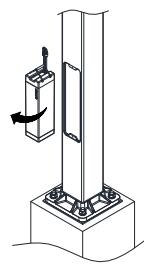

3. Take the
battery out

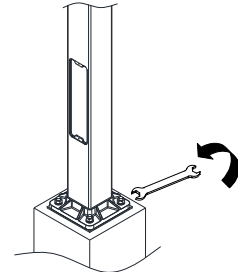

4. Remove the
fixing nuts

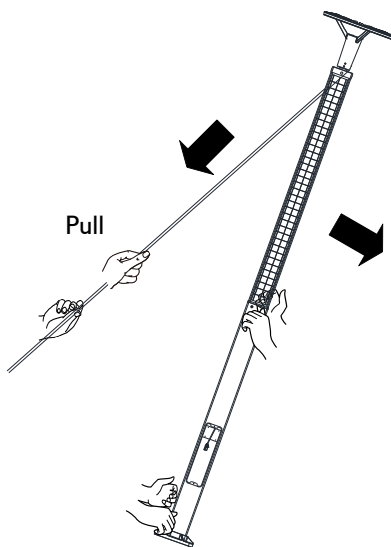

5. Lay down the pole carefully and put it on a soft pad (like wood) to protect the PV panel during the whole replacement process. Do not hit the panel with hard objects such as stones, metal rods etc.

Note:

Whoever installs the system takes full responsibility for safety during this process.

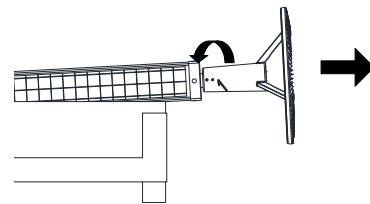

6. Remove the luminaire

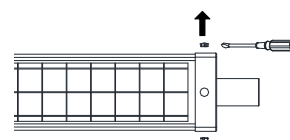

7. Remove plastic caps

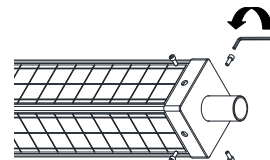

8. Remove four bolts

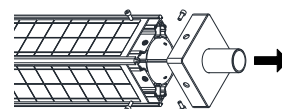

9. Remove the top part

PV panel Replacement-UrbanSpark

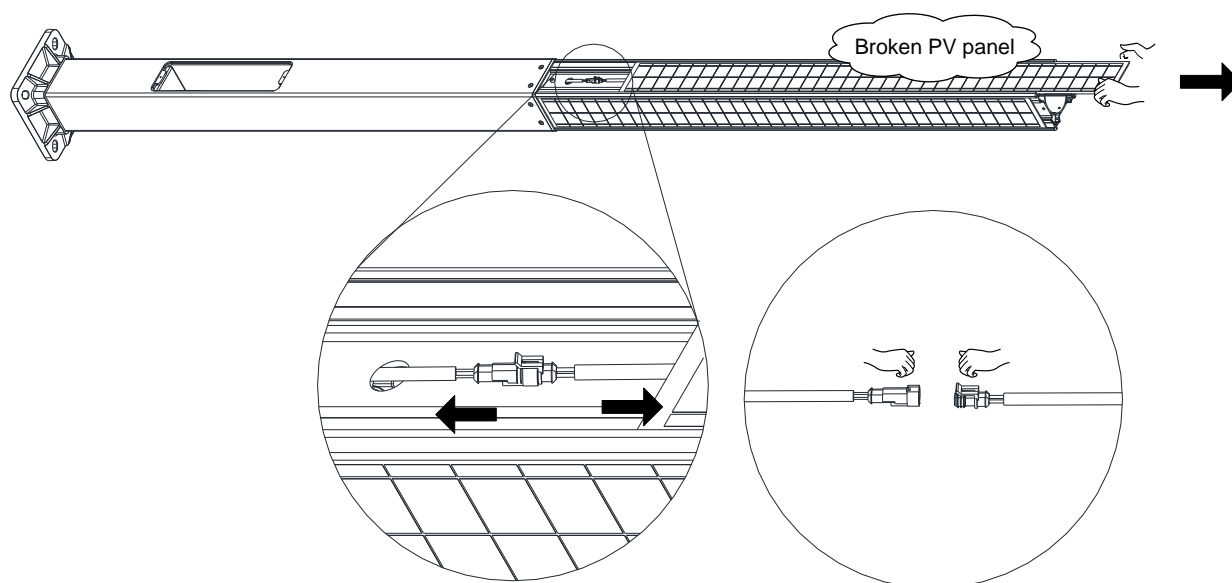

10. Pull out the broken PV panel at a distance of 20cm to the bottom pole carefully, and take out the plugs from the pole. carefully disconnect the plugs, then remove the broken PV panel.

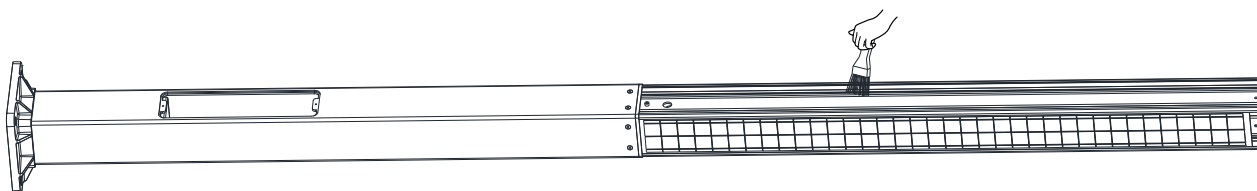

11. Clean glass culet with brushes carefully.
And brush some soap-suds on the rubber mat for lubrication.

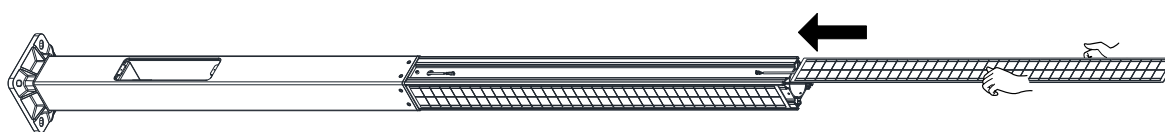
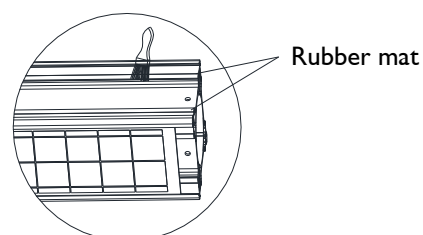

12 Insert the good PV panel to the pole carefully,
Do not bend the PV when inserting.
(You can use glass sucker for inserting easily.)

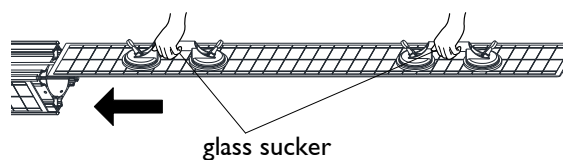

Note: You must test the PV panel's voltage before assembling it to the pole. The voltage value should be 10V~23V. You cannot install the PV panel which value is less than 10V or above 23V.

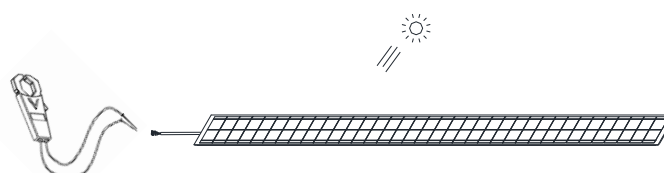

PV panel Replacement-UrbanSpark

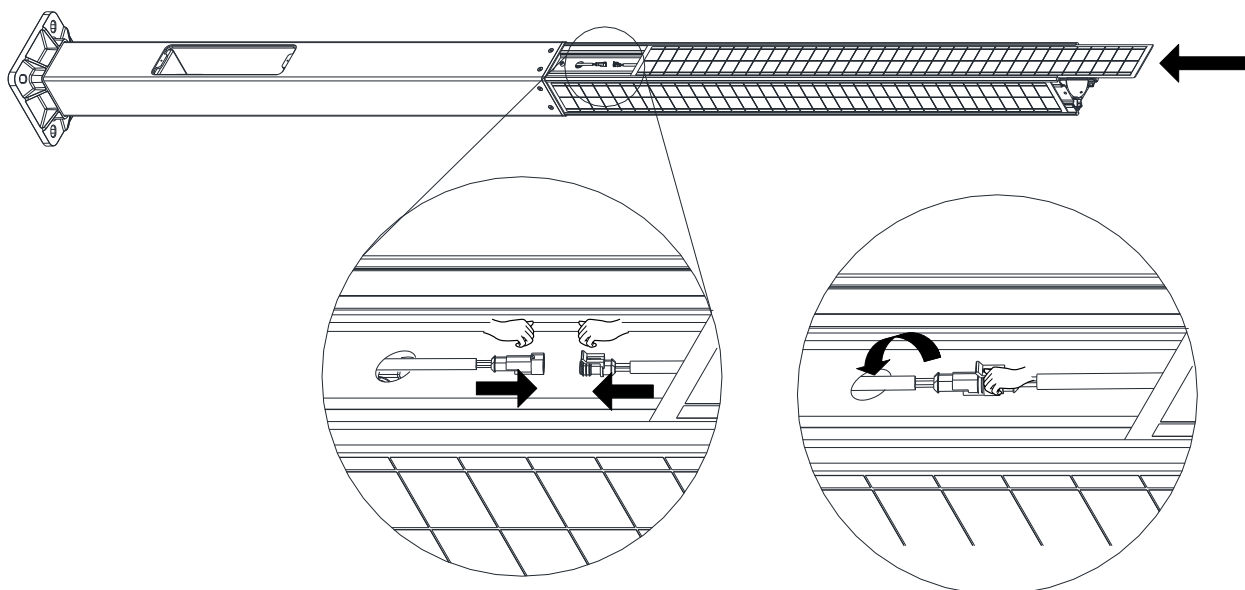

13. Push the good PV panel at a distance of 20cm to the bottom pole, and connect the plugs until you hear a “click” sound, then put the plugs into the pole through the hole.

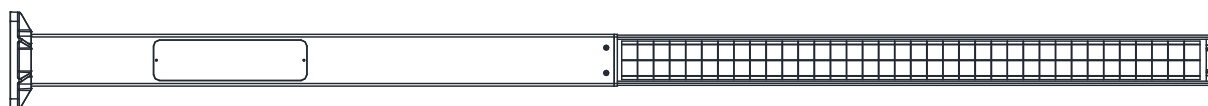

14. Push the good PV panel to the end.

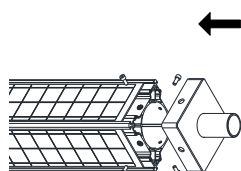

15. Assemble the top part.

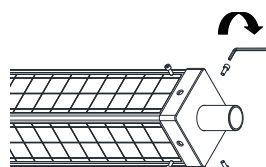

16. Fix four bolts

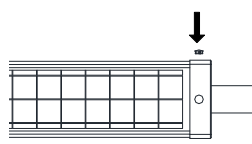

17. Cover plastic caps

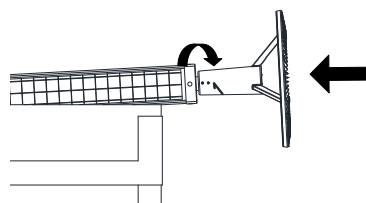

18. Assemble the luminaire

PV panel Replacement-UrbanSpark

Note:
Whoever installs the system
takes full responsibility for safety
during this process

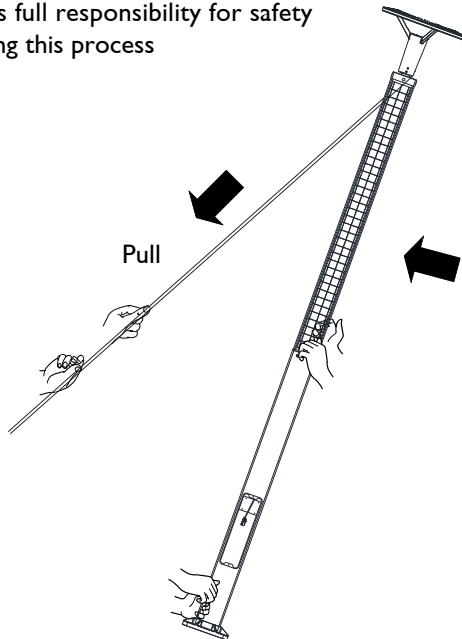

19. Erect the Pole carefully

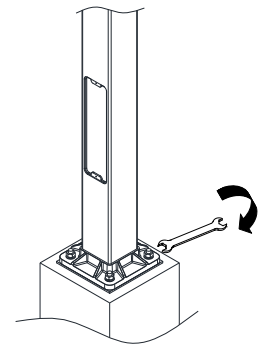

20. Affix the pole with M20 Nuts, spring washers and flat washers

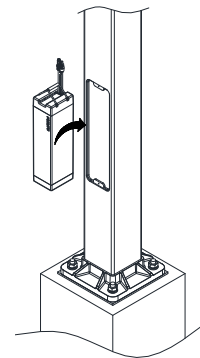

21. Put battery into the pole.

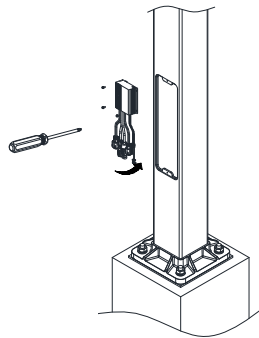

22. Affix controller on
the beam of the pole
with four screws.

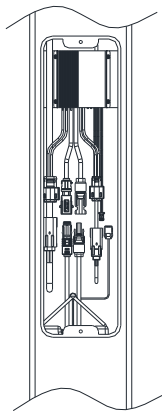

23. Connect cables,
Please follow the <Mounting
Instruction-UrbanSpark>.

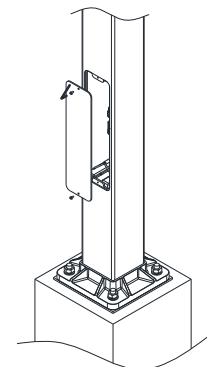

24. Lock the service
door at the end.