

PHILIPS

hue personal
wireless
lighting

**Hue Play light bar
extension**



User manual
Notice d'emploi
Manual de usuario

Incl.

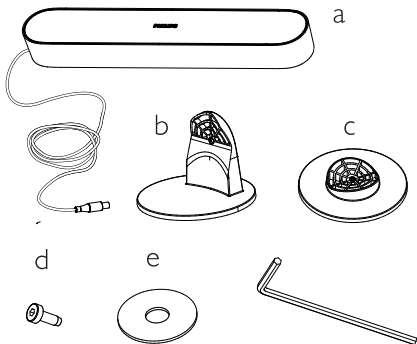

use with power supply/utilisez avec
alimentation/usar con adaptador

S021KM2400088

S020XM2400083



MAX. 20W



- EN** Product appearance may vary from image shown.
SAVE THESE INSTRUCTIONS for future reference
- FR** L'apparence du produit peut différer de l'image montrée.
CONSERVEZ CES INSTRUCTIONS pour référence future
- ES** La apariencia del producto puede variar de la imagen mostrada.
GUARDE ESTAS INSTRUCCIONES par referencia futura

Especificaciones eléctricas solo para México:

Luminario: 24 V --- 0.275 A 6.7 W

Adaptador S020XM2400083:

Entrada: 100 - 240 V \sim 50 - 60 Hz 0.6 A

Salida: 24 V --- 0.83 A 20 W

Adaptador S021KM2400088:

Entrada: 100 - 240 V \sim 50 - 60 Hz 0.6 A

Salida: 24 V --- 0.88 A 21 W

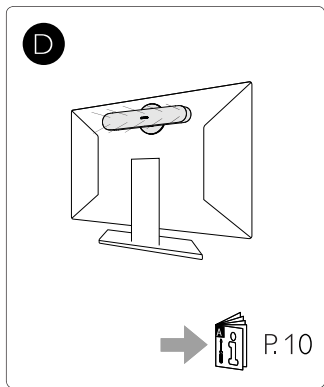
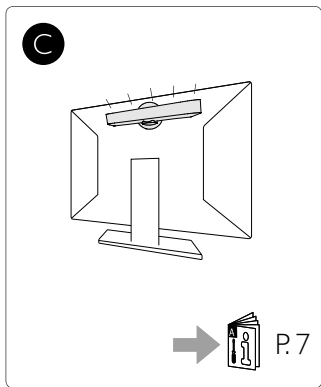
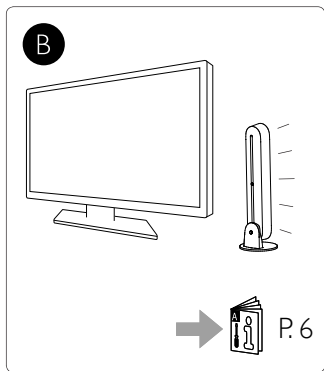
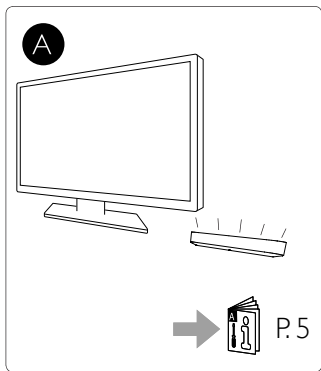

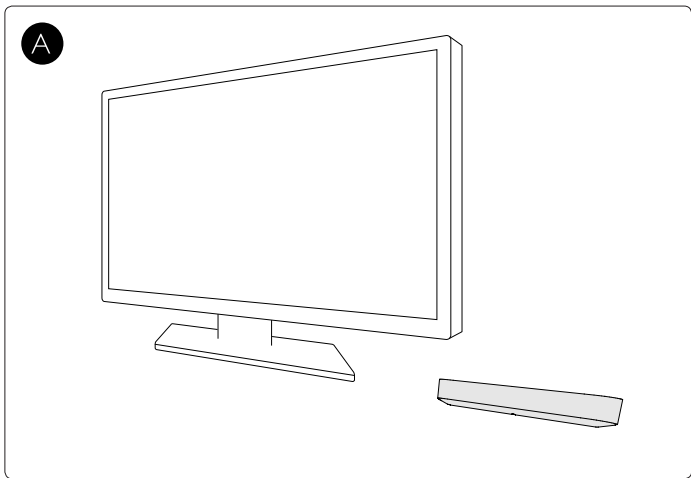
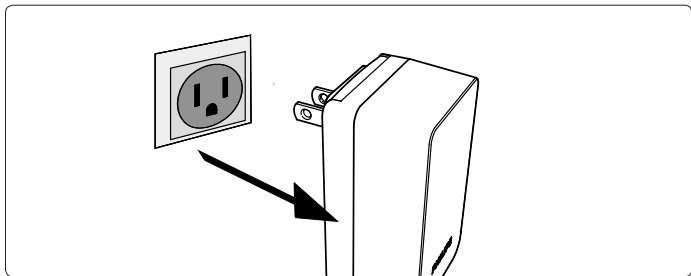

B

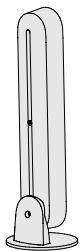
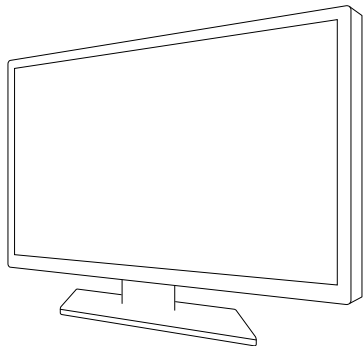

1

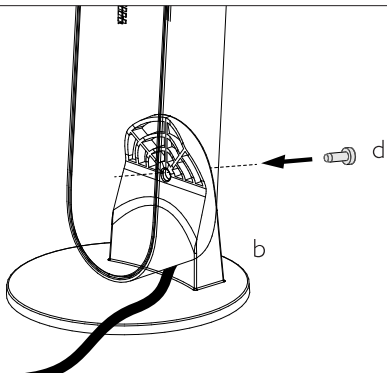

C

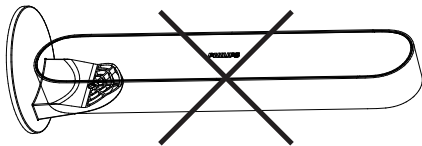
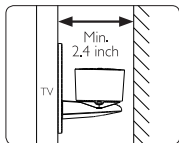
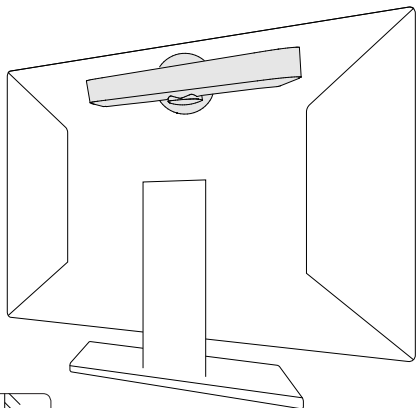

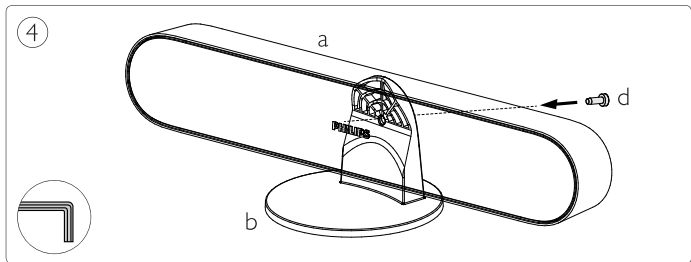
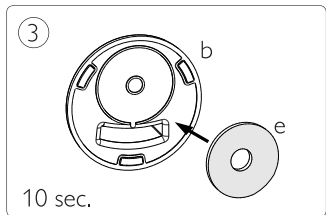
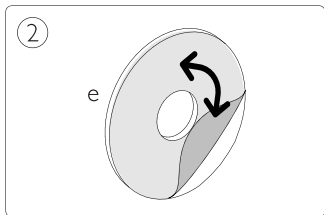
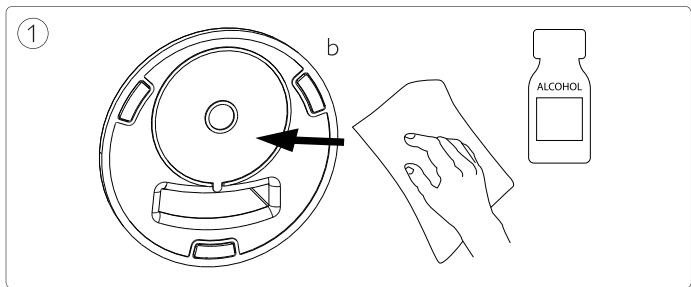

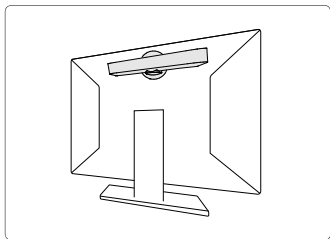
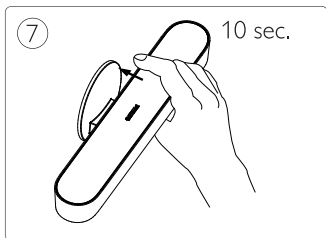
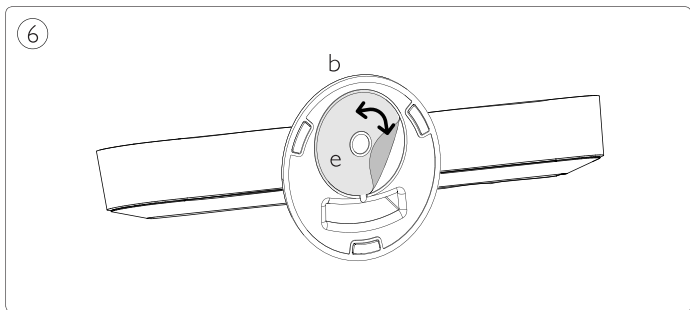
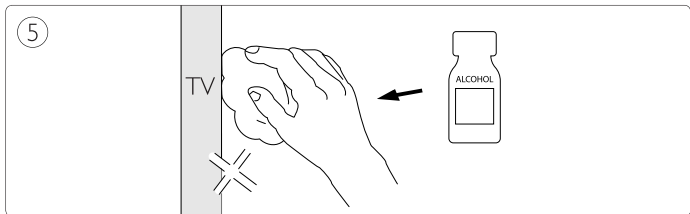

D

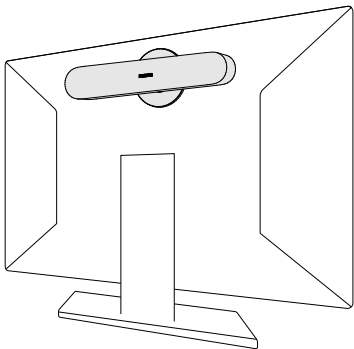
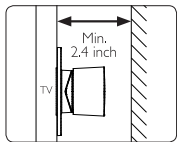

1

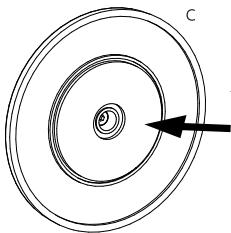

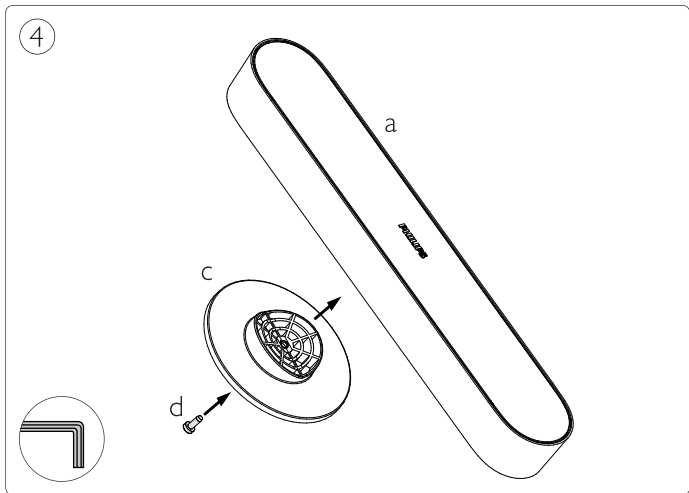
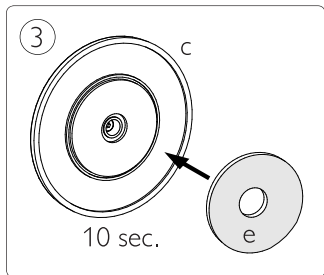
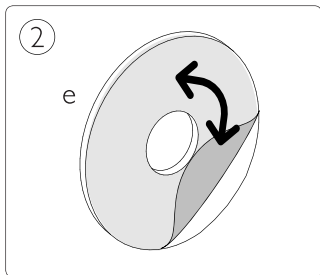

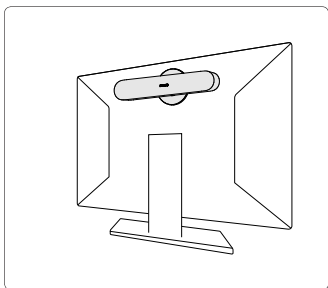
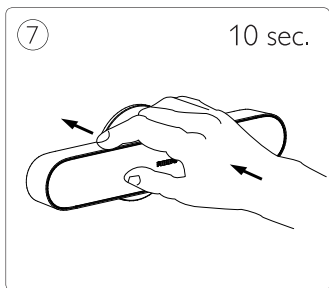
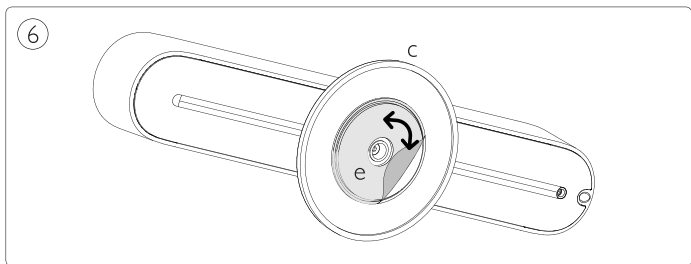
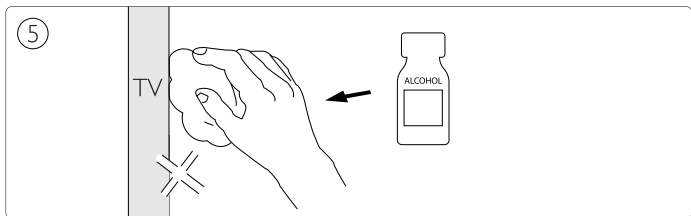

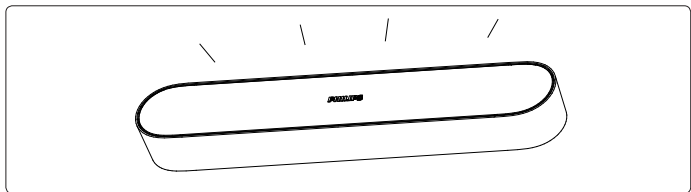
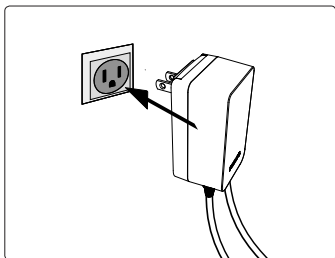
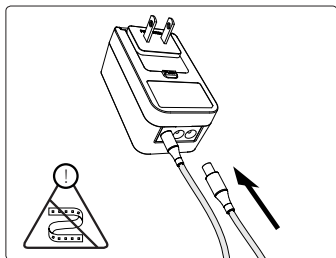

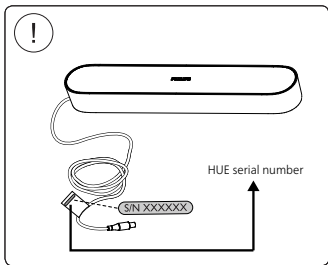



Signify North America Corporation
400 Crossing Blvd, Suite 600
Bridgewater, NJ 08807, USA

Signify Canada Ltd./Signify Canada Ltée.
281 Hillmount Road,
Markham, ON, Canada L6C 2S3
Questions or Comments / Questions ou commentaires :
1-800-555-0050

Importado y/o distribuido en México por:
Signify Mexico S.A. de C.V.
Av. La Palma N° 6
La Herradura Huixquilucan
Edo. De México, C.P. 52784 - R.F.C. PME-620620-E84

Centro de contacto:
01-800-508-9000

© 2022 Signify Holding
All rights reserved.

www.philips-hue.com

4404 029 10685
Last update: 04/2022