

Project: \_\_\_\_\_

Location: \_\_\_\_\_

Cat.No: \_\_\_\_\_

Type: \_\_\_\_\_

Lamps: \_\_\_\_\_ Qty: \_\_\_\_\_

Notes: \_\_\_\_\_

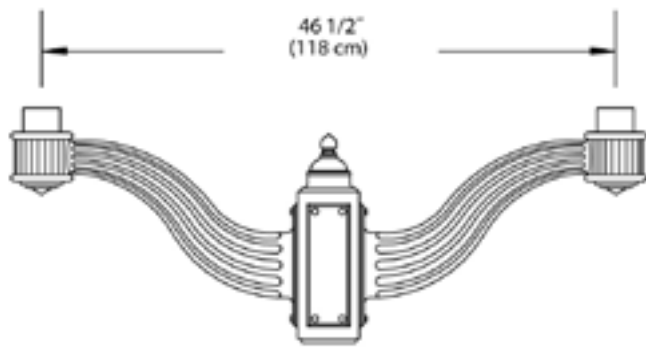

### Ordering Guide

Example: PTH2430 P3 A

<b>Product Code</b>	PTH2430	Triple
<b>Post diameter</b>	P3 P4	3" Post Mount 4" Post Mount
<b>Finish</b>	A B G H J	Black White Verde Bronze Green

### Specifications

**HOUSING:**

356 HM high-strength, low-copper, proprietary cast aluminum alloy .

**FINISH:**

Thermoset polyester powdercoat is electrostatically applied after a five-stage conversion cleaning process and bonded by heat fusion thermosetting. Laboratory tested for superior weatherability and fade resistance in accordance with ASTM B117 specifications. For larger projects where a custom color is required, contact the factory for more information.

**MOUNTING:**

Cast Aluminum Hub mounts to a 3" OD x 3" long (P3) [if applicable] or 4" OD x 6 1/2" long (P4) [if applicable] tenon and is secured with at least (3) 5/16"-18 stainless steel set screws.

**WARRANTY:**

Three-year limited warranty.

**Height :**

17" (43 cm)

**Length:**

46 1/2" (118 cm)

**EPA:**

2.59 sq. ft.

