

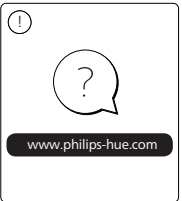

HUE serial number

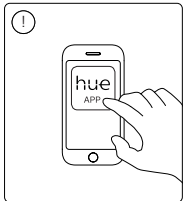

User manual  
Benutzerhandbuch  
Notice d'emploi  
Manual de usuario  
Manual do usuário  
Manuale d'uso

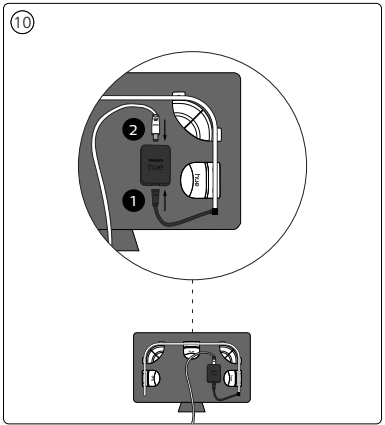
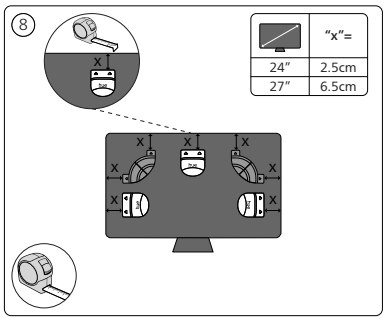
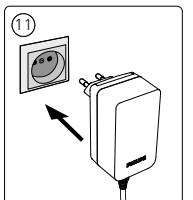
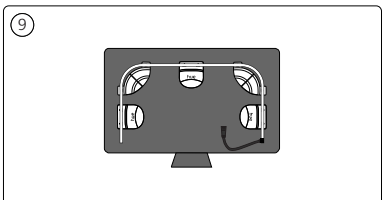
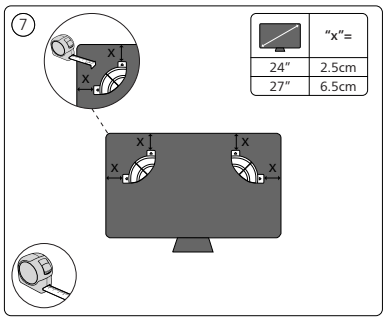
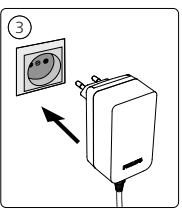
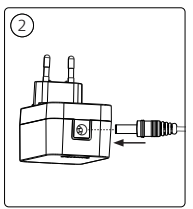
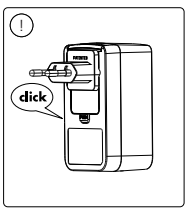
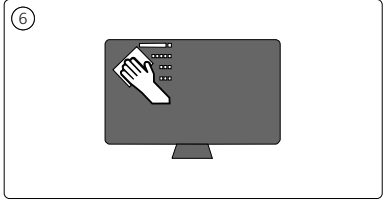
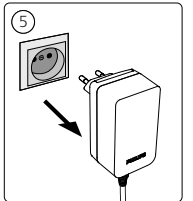
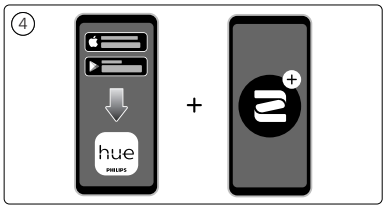
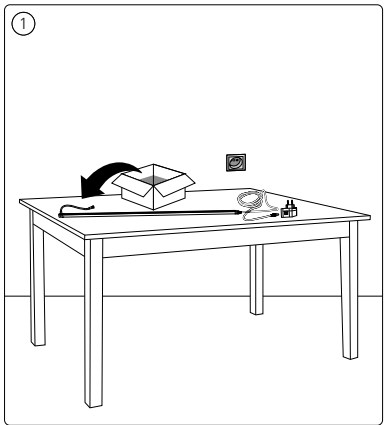
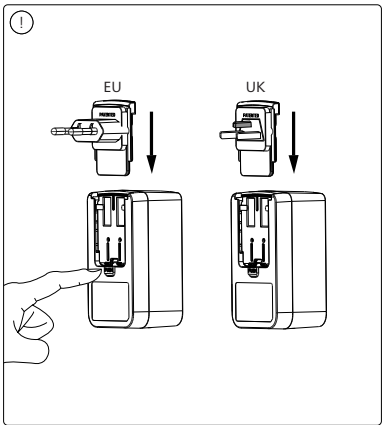
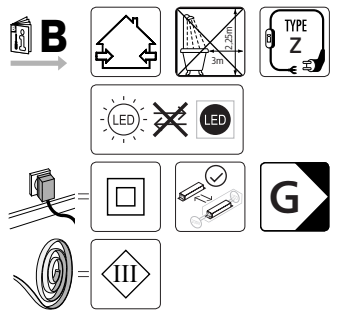
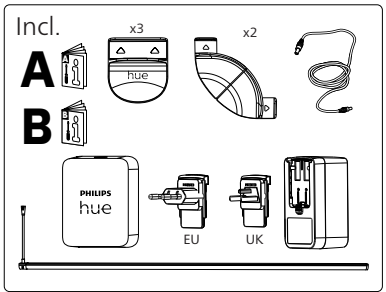

Signify  
I.B.R.S. / C.C.R.I. Numéro 10461  
5600 VB Eindhoven,  
the Netherlands  
000800-74454775

[www.philips-hue.com](http://www.philips-hue.com)  
3222 639 10162  
Last update: 03/2022

© 2022 Signify Holding  
All rights reserved