

PHILIPS
LIGHTOLIER



Downlighting

Introducing: LyteProfile and
LyteCaster LED

A simple path to choose

Defining LED Downlights

Less time, more choice, **just right**

LED technologies continue to transform the entire lighting industry, and downlighting is no exception. In fact, downlighting was one of the first lighting applications to commercially embrace LED, with its long lifetimes, robust efficiency, sustainability and low energy costs. The 2009 introduction of the 4" 1000lm Calculite LED designed for 50,000 hours rated life¹ set the standards for the modern LED downlighting industry. Philips Lightolier remains the trusted leader in LED downlighting with an unmatched commitment to technology leadership, reliability, and practical solutions to beautifully light your most important projects.

Now, we've made it even easier for you to specify LED downlights without investing considerable time or compromising your expectations. This means that you can easily and confidently implement the downlighting solution best suited to your needs. Our complete Philips Lightolier LED downlight line-up, consisting of Calculite LED, LyteProfile LED and LyteCaster LED, allows you to easily and quickly find the downlight that complements your application.

1. Product designed for 50,000 hours rated life at 70% lumen maintenance per LED manufacturer's recommendations.

de·fin·ing [di - 'fīn - ēn]:

The downlighting industry

Philips Lightolier has an unmatched commitment to the downlighting industry with over 60 years of continuous innovation and market leadership. With these new LED families Philips Lightolier takes the next step in defining the downlighting industry.

1952

Calculite introduces Colouvered downlights featuring a Fresnel lens, and small aperture.

1955

Lightolier introduces the Torsion Tight springs (known as the torsion spring).

1961

Calculite Introduces the Multi-groove baffle to leverage high output lamps while reducing aperture luminescence.

1962

Unitized construction for adjustable accent and wall washers which offers fool proof installation.

1967

Lytcaster introduces a shallow product line specifically designed for 8" joist construction.

1976

Calculite modular lighting system 1976.

1980

Introduction of the 1102 Lytcaster family and go-fast modular approach to downlighting.

1983

Lightolier introduces the ability to hot aim luminaires for lighting professionals.

1983

Lightolier begins utilizing integrated thermal protection in recessed luminaires.

1986

Modular architectural CFL downlight family, 6132, that remains state of the art until Calculite LED.

1994

Calculite introduces ProSpec (modular recessed downlighting system) which as fully convertible system that can convert A, to B, to C.

1997

Lytcaster Lytening family revolutionizes ease of installation mixed with quality and affordable lighting for residential use.

1999

Calculite Evolution series takes architectural lighting to new level of sophistication offering a complete product family in 4" and 6" apertures for the specification residential and hospitality business.

2003

Calculite introduces the Steel Frame to enable quick ship architectural downlighting.

2007

LytCaster introduces Uniframe.

2008

Philips completes acquisition of Lightolier.

2009

Calculite introduces the 1000lm 4" LED downlight which is recognized at the product innovation of the year at Lightfair International.

2010

Calculite introduces the 1.75" LED Downlighting Family which capitalizes on the new LED light engine.

2011

Calculite introduces Hot Rep remote phosphor to continue to lead the market in LED technology.

2013

Calculite introduces Calculite White LED, replacing all products 500lm to 3500lm in 4", 6", 7" and 8" apertures to continue to lead the industries technology curve.

2014

Calculite introduces industry leading performance and sophistication in the 6000lm recessed and cylinder offerings.

2014

Calculite introduces industry leading accent performance in a 4" accent fixture delivering 32,000cd in a 4" aperture at a 40° angle.

2014

Lightolier introduces the LyteProfile product family which defines the practical commercial downlight offering.

2015

Lightolier introduces LyteCaster LED which defines the general purpose downlights in the 3", 4", 5", 6" residential and light commercial markets.

de·fin·ing [di-ˈfīn-ēn]:

Streamlined selection

Specification downlights

Philips Lightolier **Calculite LED**

Architectural-grade downlighting that offers the best combination of technology and product design to provide discrete illumination.



Commercial downlights

Philips Lightolier **LyteProfile LED**

Performance-grade downlighting that maximize efficiency, design versatility, and ease of installation.



General purpose downlights

Philips Lightolier **LyteCaster LED**

Value-driven downlighting for light commercial and residential spaces.



Modularity with **mix and match** choices



Each Philips Lightolier LED Downlight product tier includes a versatile array of options including aperture size, lumen package, reflector finish, color temperature and color rendering (CRI), dimming, and more. Additionally LyteProfile and LyteCaster incorporate a modular design of housing, trim and LED light engine, thus future proofing your selection so that you can upgrade the downlight as requirements and technology evolve.

Confidence where it counts

The wide range of products and options means that you can seamlessly blend Philips Lightolier LED Downlights into any project area, while the common aperture size frees you from constraint if unexpected project changes occur. We manufacture all Philips Lightolier LED luminaire components, including the reflector, LED board and drive, to work seamlessly together for efficient, reliable performance.

Additionally, these new Philips Lightolier LED Downlights are Energy Star certified and offer 5-year limited system warranties². With over 60 years of continuous Philips Lightolier innovations, you can be assured of high-quality products without compromise.

² For warranty details and restrictions please visit www.philips.com/warranties

More choices in **less time**

Three dimmable Philips Lightolier LED Downlight product tiers each blend the latest LED technology with versatile options to suit any application and budget. Our new consistent and easy-to-use part numbering logic means that you can quickly select the downlight you need, and ultimately complete projects faster.

The sample configurations below are for illustration purposes only. Please check individual specification sheets for exact ordering options in each family.

example: **Frame-In kit**

Family	Aperture	Shape	Frame Type	Lumen	Construction Type	Dimming
P LyteProfile LED	6 6"	R Round	D Downlight	15 1500	N Non-IC New Construction	Z10 0-10V
L LyteCaster LED	5 5"	R Round	-	-	AN AirSeal IC New Construction, Nail	E Dimming ELV

example: **Light engine**

Family	Aperture	Shape	Type	Lumen	CRI	CCT's
P LyteProfile LED	6 6"	R Round	D Downlight	-	8 80	35 3500K
L LyteCaster LED	5 5"	R Round	-	10 1000	9 90	27 2700K

example: **Trim**

Example: L5RBW

Family	Aperture	Shape	Luminaire Type	Beam	Trim Finish	Flange	Version
P LyteProfile LED	6 6"	R Round	LW Lensed wall wash	-	D Clear Diffused	P Polished (matching)	-
L LyteCaster LED	5 5"	R Round	B Baffle Downlight	-	W White	- White	-

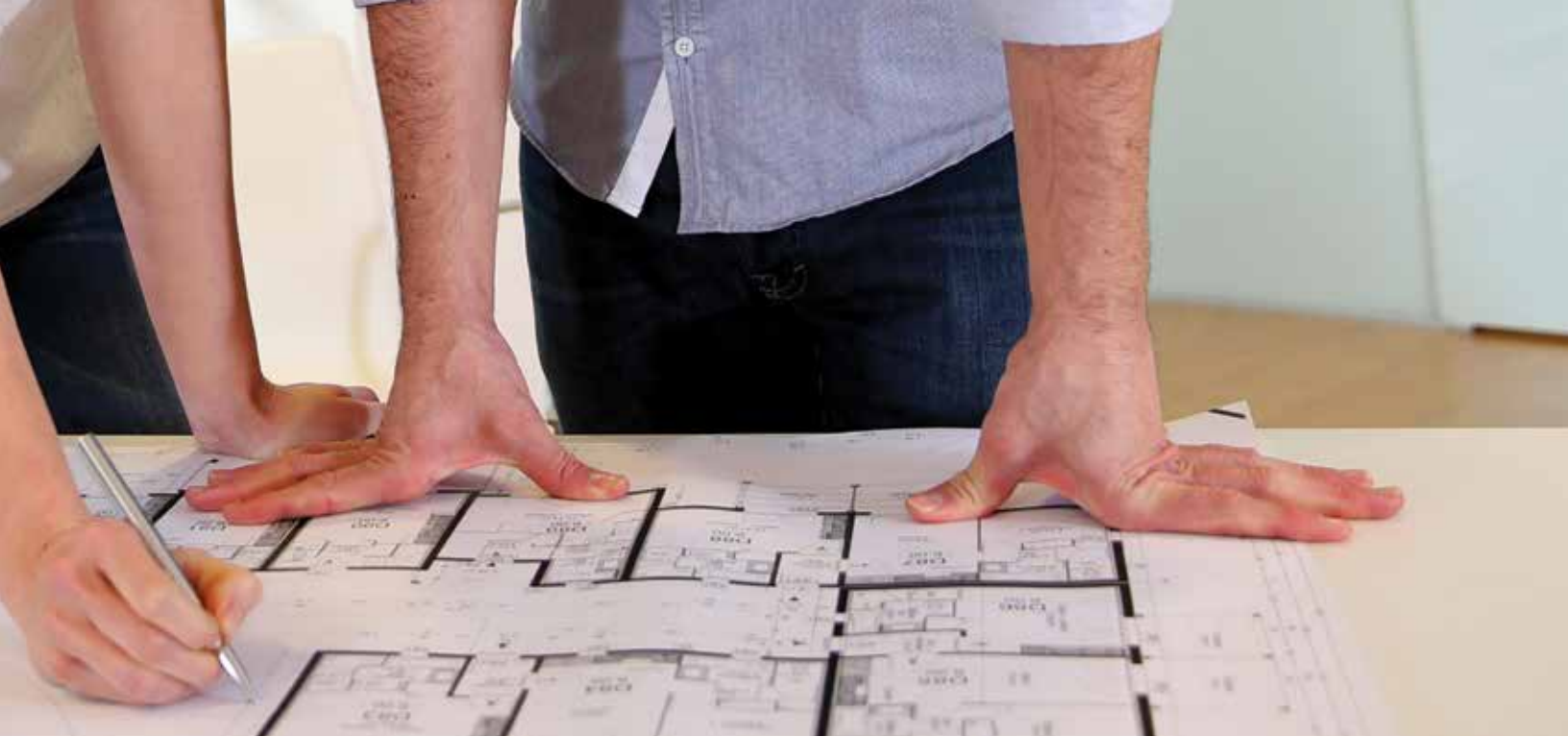

Example: L5RANE1

Input Voltage	Chicago Plenum	Version	Options
<input type="checkbox"/> U 120V-277V	<input type="checkbox"/> -	<input type="checkbox"/> VB	<input type="checkbox"/> EM Emergency
<input type="checkbox"/> 1 120V	<input type="checkbox"/> -	<input type="checkbox"/> -	<input type="checkbox"/> -



Example: L5R10927

Beam Spread	Version	Options
<input type="checkbox"/> -	<input type="checkbox"/> VB	<input type="checkbox"/> -
<input type="checkbox"/> -	<input type="checkbox"/> -	<input type="checkbox"/> -



de·fin·ing [di- 'fīn- ēŋ]:

Specification downlights

Philips Lightolier

Calculite LED Downlights:

Make a statement
with your lighting



As the premier forerunner in the downlight industry for over 60 years, Philips Lightolier Calculite consistently sets a powerful standard for aesthetics, performance and reliability. You can always be assured of balanced, comfortable lighting that seamlessly blends into the surrounding area without distraction, including downlighting and wall washing applications.

Using true 50° physical and reflected cutoff optics, Calculite LED Downlights create a remarkably quiet ceiling without harsh shadows; and the wide palette of aperture sizes, lumen outputs, reflectors and other performance and decorative options means that you can expertly personalize a downlight solution.

Calculite LED is ideal for use in:

- **Offices**
- **Sophisticated retail**
- **High-end hospitality**
- **Atmosphere or mood-driven commercial spaces**

Calculite LED - Key features:

- **Visual comfort:** Calculite utilizes a discrete source of illumination from precisely designed optics to maximize comfort and performance.
- **Wide range:** Apertures include: 1.75", 3", 4", 6", 7" and 8" with lumen packages ranging from 500lm to 6000lm. All include a variety of downlights and wall wash and full state-of-the-art accent offerings in 3" and 4" aperture.
- **Technology commitment:** Providing 75lm/W with a true 50° cut-off and technology highlighted in the 6000lm at 85+ lm/W and accent offerings providing up to 32,000cd.
- **Quality of light:** Single origin of illumination, precisely controlled optics deliver even illumination and soft transitions.
- **Versatile environment:** Robust frame-in kit construction and integrated design ensures proper optical alignment regardless of installation conditions.

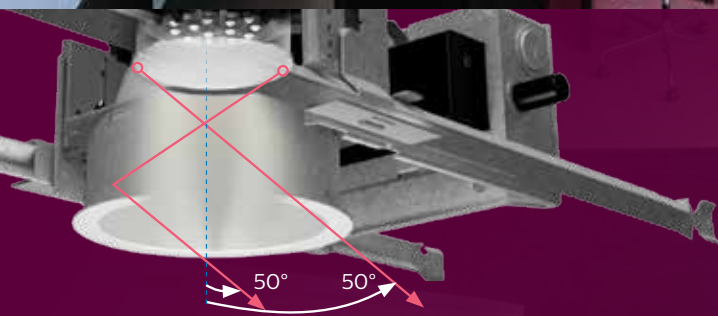

def·i·ni·tion [de-fə-'ni-shən]:

Delivered vs. source lumens

There are different ways to communicate the lumens from an LED solution. Source lumens are defined as lumen output from the LED board or LED engine. Source lumens don't account for how the LEDs work within the entire downlight system... which results in the delivered lumens. You can count on Philips Lightolier to report delivered lumens, which is indicative of the expected light output of the system.

Luminaire	Source lumens	Delivered lumens
Calculite 4" adjustable accent	2200	1500

Philips Lightolier's Calculite product portfolio has continued to define the architectural level downlighting standards since 1952. Since the 2009 introduction of Calculite LED, the product line has gone through several major technological advancements and provides a state of the art balance in lighting performance, visual comfort, and quality of light.

The unmatched commitment to lighting innovation, design sophistication and technology leadership continue to provide lighting professionals the palette of choice for their discerning clients.

The full Calculite LED Portfolio covers apertures from 1.75", 3", 4", 6", 7" to 8" and lumen packages ranging from 500 lm, 1000 lm, 1500 lm, 2000 lm, 3500 lm and 6000 lm for 25+ ceiling heights. All offerings include a variety of downlights and wall wash and full state of the art accent offerings in 3" and 4" range. Please refer to the Calculite White LED brochure for full ordering selection.





Downlight

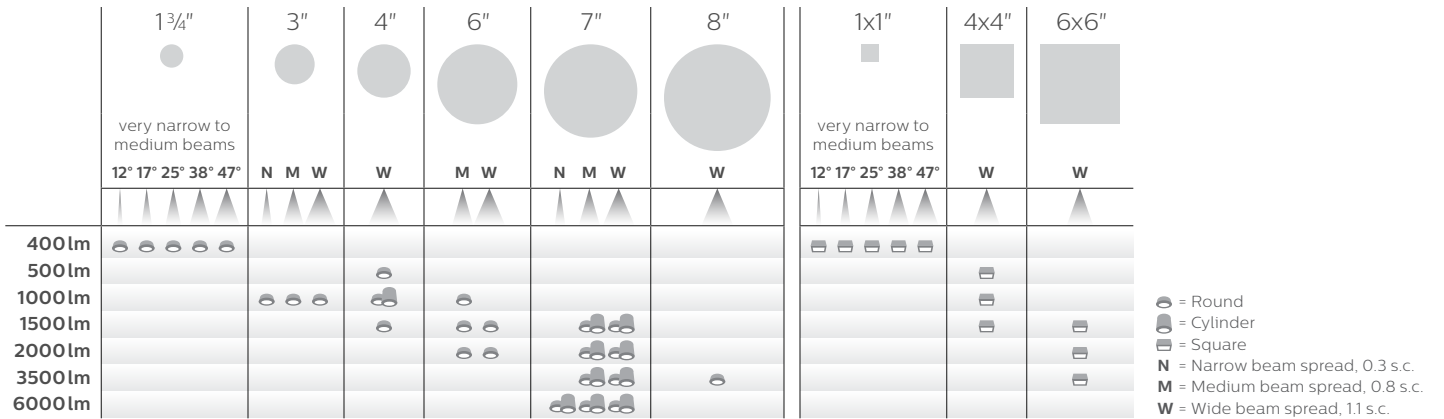

Lensed Wall Wash

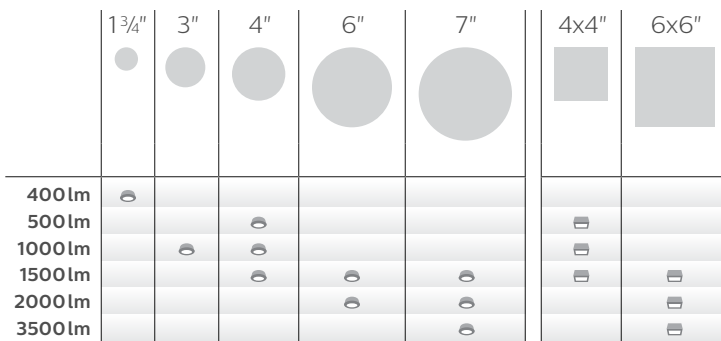

Open Wall Wash

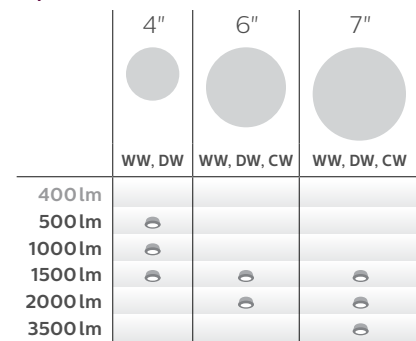

Adjustable Accent

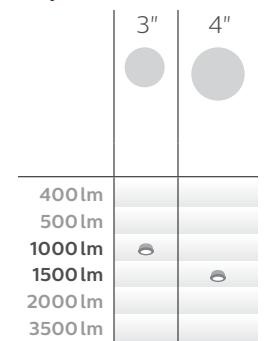



Superior Performance

LyteProfile LED Downlight fully integrated luminaire design provides nearly 100lm/W, is designed for 50,000 hours rated life at L70 and has a 5 year limited system warranty².

Model	Light Engine	Trim	Frame	Lumens	Efficacy
4"	80 CRI 3500K	Downlight Clear Reflector	Non-IC, 0-10V Dimming, Universal (120/277)	1000	95
		Downlight Lensed Wall Wash Clear Reflector	Non-IC, 0-10V Dimming, Universal (120/277)	1000	46
6"	80 CRI 3500K	Downlight Clear Reflector	Non-IC, 0-10V Dimming, Universal (120/277)	2000	98
		Downlight Lensed Wall Wash Clear Reflector	Non-IC, 0-10V Dimming, Universal (120/277)	2000	71

Configurations shown meet Energy Star certification. Other configurations available for higher efficacy. Always reference photometry files and product specification sheets for actual performance information. Specifications subject to change.

de·fin·ing [di - 'fīn - ēŋ]:

Commercial downlights

Philips Lightolier

LyteProfile LED Downlights:

Create efficiency
in your design



Philips Lightolier defines the commercial downlighting product category with LyteProfile which utilizes state of the art mid-flux LED technology to provide a highly efficient family of downlighting luminaires that provide a smooth source of illumination. The product line delivers up to 100 lm/W at the emitted luminaire level while providing a comfortable 60° cut-off to both the actual and reflected source. Cutting edge technology employs the latest in thermal management and significantly reduces the size and physical material employed in the luminaire. The product family utilizes a robust Frame-in-Kit + Light engine + Reflector design that is designed for a wide variety of installation conditions and has a maximum plenum depth of 4½".

LyteProfile LED is ideal for use in:

- Offices
- Retail
- Hospitality
- Healthcare

LyteProfile LED - Key features:

- **Innovative design:** Latest technology in LED design and integrated thermal management provide a quality product offering that is simple, and sophisticated that will meet your commercial budget requirements.
- **Simple versatility:** Designed to meet standard commercial lighting requirements with choices of 1000 lm, 1500 lm or 2000 lm downlight or lensed wall wash in either a 4" or 6" apertures; and up to 2500 lm in the 6" aperture. It is also available in 2700K, 3000K, 3500K, and 4000K.
- **Cutting edge technology:** Innovative mid-flux LED design eliminates pixelation and provides smooth, even illumination with simplified thermal management.
- **Robust housing design:** This commercial housing is designed for a wide variety of construction and ceiling conditions; fixture depth remains below 4½" deep and allows for a consistent 2" ceiling depth.

de·fin·ing [di- 'fīn- ēŋ]:

General purpose downlights

Philips Lightolier

LyteCaster LED Downlights:

Discover comfort with
a shallow design



Philips Lightolier LyteCaster LED Downlights are the ideal general purpose downlighting solution, providing comfortable, quality light in any space. LyteCaster LED Downlights offer a luminaire height that is lower than a typical luminaire to conserve valuable plenum space.

The contractor-friendly housing offers tool-less installation, offset apertures and pivoting mounting bars for fast, easy and reliable installations.

Dimmable LyteCaster LED Downlights are ideal for use in:

- Residential spaces
- Light commercial spaces
- Wet indoor spaces such as bathrooms and showers

Lytecaster LED - Key features:

- **Shallow luminaire height:** Save plenum space without compromising the 70° physical and reflected cut-off which lends to comfortable illumination. The frame is built-in with multiple features for easy installation making it contractor friendly. It can also be installed in walls. A shallow 3 3/4" Accent Family with full range of trims, adjustables and gimbals is also available.
- **Modular and innovative light engine:** Interchangeable and upgradable while easy to install, available in a wide choice of CCT's, CRI and Warm glow. It is designed without a heavy die-cast heat sink which results in a lightweight luminaire that is a fraction of the weight of its predecessor, Xceed, and its competitors.
- **High performance:** Up to nearly 90 lm/W provides greater cost and energy savings (up to 1500 delivered lumen available).
- **Adjustable gimbal design:** Low cost solution for Slope ceiling and wall washing application.
- **Warm glow dimming:** Provides an alternative to a BR30 65W recessed housing in LED. Warm glow can dim from 2700K-2200K, similar to an incandescent when dimmed.





MR16 vs. LED

The integrated LED family is an affordable solution to traditional low-voltage luminaires with MR16 lamps. With efficacies ranging up to 80lm/W, LyteCaster LED Accent offers visual comfort with no visible striations in a wide range of beam spreads, color temperatures, and CRIs to choose from.

Model	Beam	CBCP (cd)	Power	Flux (lm)	Efficacy (lm/W)	Life (hr)	Chromaticity
LyteCaster LED Accent*	22°	3690	11W	819	69.4	50,000 (L70)	3-step
LytePoint with LED MR16**	24°	2840	12W	650	54.2	30,000 (L70)	6-step
LytePoint with LV Halogen MR16***	24°	2500	57W	800	14.0	6,000 (ARL)	n/a

Data values are based on total system outputs and not standalone light sources.

* L308830NF

** 10MR16/F24 3000 DIM HO 10/1

*** 50MR16/MFL24 EXZ

de·fin·ing [di - 'fīn - ēŋ]:

General purpose downlights

Philips Lightolier

LyteCaster LED

Accent:

Design versatility
to fit any space



The Philips Lightolier LyteCaster 3" LED Accent is a versatile family designed for commercial and residential areas. The family is available in a variety of round and square accent styles and finishes with efficacies ranging up to 80 lm/W. A wide range of beam spreads, color temperatures, 80 or 90 CRI, and dimming options allow you to customize your lighting solution to best suit the application. LyteCaster's shallow luminaire height and 3 part modular system provides for easy installation and upgradeability in any space.

LyteCaster LED Accent is ideal for use in:

- Residential spaces
- Specialty retail
- Restaurants and Hotels
- Wet indoor spaces such as bathrooms and showers

LyteCaster LED Accent - Key features:

- **Shallow luminaire height and modular light engine:** LyteCaster LED Accent shares the same frame for the downlight which allows for the same shallow height. The light engine is also modular for easy future upgrades.
- **Style variation:** LyteCaster LED Accent allows for sophisticated style variation with round and square downlights, adjustables, wall washer, and shower light options. Round pinholes and gimbals are available as well. Spot, flood, and narrow flood beam distributions are available.
- **CrispWhite technology:** CrispWhite provides the perfect combination of warm saturated colors with bright vibrant whites. CrispWhite is available in the 90 CRI 3000K combination.
- **Performance:** Designed for peak performance and lifetime in recessed applications.
- **Remodeler option:** Remodeler option is available for all downlights and gimbals in both round and square options.

Select the Philips Lightolier solution that is

best for your project

	Specification downlights	Commercial downlights	General purpose downlights
	Calculite LED	LyteProfile LED	LyteCaster LED
Aperture size (Nominal)	1.75", 3", 4", 6", 7", 8"	4" and 6"	3", 4", 5", 6"
Lumens	500, 1000, 1500, 2000, 3500, 6000	1000, 1500, 2000 2500	650, 800 (accent) 1000, 1500
CCT	2700, 3000, 3500, 4000	2700, 3000, 3500, 4000	2700, 3000, 3500
CRI	80, 90	80	80, 90
Housing	IC/Non-IC	Non-IC	IC/Non-IC , Remodeler ³
Plenum depth	Varies (consult spec sheet)	4.5"	3.5"
Dimming	Z10V, Lutron, DALI	Z10V, Lutron	ELV 120V, 0-10V Universal
Options	Emergency, 347V	Emergency, 347V	Warm glow (5" downlight only, 700lm) CrispWhite (90CRI, 3000K in 3" Accent))
Types	Downlight Adjustable accent Wall wash single, double and corner Cylinder Slope	Downlight Wall wash	Downlight Slope/Wall wash Adjustable accent Downlight accent
Forms	Round and square	Round	Round and Square (3" only)
Finishes	4	4	3 Downlight 4 Accent
Applications	Commercial Architectural High end residential	Commercial VE alternative to Calculite LED Downlights	Residential Light commercial
Cut-off angle	Best (50°)	Better (60°)	Good (60-70°)
UL listed	Wet location	Wet location	Wet location (3" shower lights, and 4", 5", 6" downlights), Damp location (3" accent, and 4", 5", 6" adjustables)
Approbations	Energy Star, T24	Energy Star	Energy Star, T24
Rated life	60,000 hours at L70	50,000 hours at L70	Up to 50,000 hours at L70
System warranty ²	5 years	5 years	5 years

For more information on our complete Philips Lightolier line-up, including specification sheets, visit philips.com/leddownlights or contact your local Philips representative.

2. For warranty details and restrictions please visit www.philips.com/warranties.

3. Remodeler is only available in the 3" Accent Series.



Commercial downlights

LyteProfile LED Downlights:



Complete product = Frame-in kit + Light engine + Trim. Order each separately.

Frame-In kit⁴

Series	Size	Shape	Frame Type	Lumens	Installation	Dimming	Input voltage	Version	Options
P		R	D		N			VB	
P LyteProfile LED	4 4 inch	R Round	D Downlight	10 1,000 lm	N Non-IC New construction	Z10 0-10V Dimming Lutron	U Universal (120/277v)	VB Version B	EM Emergency
				15 1,500 lm					
				20 2,000 lm					
				25 2,500 lm					
	6 6 inch	R Round	D Downlight	10 1,000 lm	N Non-IC New construction	Z10 0-10V Dimming Lutron	U Universal (120/277v)	VB Version B	EM Emergency
				15 1,500 lm					
				20 2,000 lm					
				25 2,500 lm					

Light engine

Series	Size	Shape	Type	CRI	CCT	Version
P		R	D	8		VB
P LyteProfile LED	4 4 inch	R Round	D Downlight	8 80	27 2700K	VB Version B
	6 6 inch				30 3000K	
					35 3500K	
					40 4000K	

Reflector

Series	Size	Shape	Style	Reflector	Flange
P		R			
P LyteProfile LED	4 4 inch	R Round	D Downlight	CL Clear	Blank White (painted)
	6 6 inch		LW Lensed wall wash	CC Comfort clear	P Polished (matches aperture)
				D Clear diffuse (applied)	
				W White (painted)	Blank White (painted)

4. Mounting Bars: 1950-18" (set of 2) 1951-27" (set of 2). And T-Bar anchor clips: 1956 (set of 4, for use with mounting bars) need to be ordered separately.

5. Not available with Emergency.

General purpose downlights

LyteCaster LED Downlights:



Downlight = Frame-in kit + Light engine + Trim

Adjustable = Frame-in kit + Light engine/trim combined

Order each part separately

Frame-In kit (downlight and adjustable)

Series	Size	Shape	Frame type	Dimming	Input voltage
L	4	R	A	E	1
L LyteCaster LED	4 4 inch	R Round	A AirSeal IC, New construction, Screw	E Dimming ELV ⁶ Z10 0-10V	1 120V U Universal
	5 5 inch		AN AirSeal IC, New construction, Nail		
	6 6 inch				
5 5 inch	R Round	A	A AirSeal IC, New construction, Screw	EWG ELV/Triac warm glow dimming effect ⁷	1 120v
			AN AirSeal IC, New construction, Nail		

Light engine (downlight only)

Series	Size	Shape	Lumens	CRI	CCT
L	4	R	06	8	27
L LyteCaster LED	4 4 inch	R Round downlight	06 650lm	8 80	27 2700K
	5 5 inch	R Round downlight	10 1000lm	9 90 ⁸	30 3000K 35 3500K
	6 6 inch	R Round downlight	15 1500lm		
5 5 inch	R Round downlight	07 700lm	8 80	WG 2700K-2200K	

Trim (downlight only)

Series	Size	Shape	Luminaire type	Finish
L	4	R	D	D
L LyteCaster LED	4 4 inch	R Round	D Open downlight	D Clear diffuse (with white flange)
	5 5 inch			W White (with white flange)
	6 6 inch		B Baffle downlight	W White (with white flange)

Adjustable Light Engine/Trim (adjustable only)

Series	Size	Shape	Lumens	CRI	CCT	Finish
L	4	RA	06	8	27	W
L LyteCaster LED	4 4 inch	RA Round adjustable	06 650 lm	8 80	27 2700K	W White (with white flange)
	5 5 inch	RA Round adjustable	10 1000 lm	9 90 ⁸	30 3000K 35 3500K	
	6 6 inch	RA Round adjustable	15 1500 lm			

6. 4" has ELV/Triac dimming.

8. 90 CRI is only available with 2700K.

7. Warm glow dimming effect is not available in adjustable.

General purpose downlights

LyteCaster LED Accent:



Complete product = Frame-in kit + Light engine + Trim. Order each separately.

Frame

Series	Size	Construction	Dimming	Input voltage
L	3	<input type="checkbox"/>	<input type="checkbox"/>	<input type="checkbox"/>
L LyteCaster LED Accent	3 3 inch	A AirSeal IC, New construction, Screw AN AirSeal IC, New construction, Nail C Remodeler Non-IC	E Dimming ELV/ Triac	1 120V
		N New construction Non-IC	Z10 0-10V	U Universal (120- 277V)

Light engine

Series	Size	Lumens	CRI	CCT ⁹	Beam	Option
L	3	08	<input type="checkbox"/>	<input type="checkbox"/>	<input type="checkbox"/>	<input type="checkbox"/>
L LyteCaster LED Accent	3 3 inch	08 800 lm	8 80	27 2700K 30 3000K 35 3500K	S Spot (17°) NF Narrow flood (22°) F Flood (33°)	
			9 90	27 2700K 30 3000K ¹⁰	S Spot (17°) NF Narrow flood (22°) F Flood (33°)	CW CrispWhite ¹⁰

Trims

Series	Size	Shape	Luminaire type	Finish	Flange
L	3	R	<input type="checkbox"/>	<input type="checkbox"/>	<input type="checkbox"/>
L LyteCaster LED Accent	3 3 inch	R Round	D Downlight A Adjustable LW Lensed wall wash	C Chrome cone D Diffuse cone W White cone	blank White flange
			B Baffle downlight AB Adjustable baffle	W White baffle	blank White flange
			G Gimbal	W White B Black A Aluminum	
			AP Adjustable pinhole	W White A Aluminum	
		S Square	D Downlight	D Diffuse cone W White cone ¹¹	blank White flange A Aluminum
			A Adjustable	D Diffuse cone	blank White flange A Aluminum
		S Square	LW Lensed wall wash		W White flange A Aluminum
		R Round	S Shower light		W White flange
		S Square			A Aluminum

Accessories: Films & holders, and field replacement optics are also available to achieve desired lighting effects. See spec sheets for further details.

9. For 4000K, consult factory.

11. White cone only available with white flange

10. 90 CRI/3000K is only available with the CrispWhite option.

The Philips Lightolier LyteCaster 3" LED Accent is a versatile family designed for commercial and residential areas in both new construction and remodel applications.

A single light engine can be specified in a round or square style to allow you to customize your lighting solution to best suit the desired effect.



Accent Lighting:

Accent lighting provides dramatic interest in a space by drawing attention to selected objects and surfaces such as artwork, place settings, and niche areas.



L3RAD: Adjustable Accent with Diffuse cone and White flange



L3SADA: Adjustable Accent with a Diffuse cone and Aluminum flange



L3RGW: White Gimbal



L3RAPA: Adjustable Pinhole Baffle with Aluminum finish



General Illumination:

General illumination provides overall illumination and defines a space.



L3RDD: Downlight with Diffuse cone and White flange

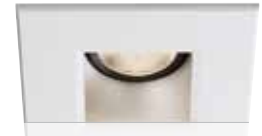

L3SDD: Downlight with Diffuse cone and White flange



Wall Wash:

Wall Washing provides a smooth, even illumination over the length and height of a wall surface.



L3RLWD: Lensed Wall Wash with Diffuse cone and White Flange



L3SLWA: Lensed Wall Wash with an Aluminum finish



Wet Location:

Wet Location provides overall illumination in locations where the light source may come into direct contact with water.



L3RSA: Shower Light with Aluminum finish



L3SSA: Shower Light with Aluminum finish



©2015 Koninklijke Philips N.V. All rights reserved. Philips reserves the right to make changes in specifications and/or to discontinue any product at any time without notice or obligation and will not be liable for any consequences resulting from the use of this publication.

PLI-1426BR 04/15 philips.com/luminaires

Philips Lighting
North America Corporation
200 Franklin Square Drive
Somerset, NJ 08873
Tel. 855-486-2216

Imported by: Philips Lighting,
A division of Philips Electronics Ltd.
281 Hillmount Rd,
Markham, ON, Canada L6C 2S3
Tel. 800-668-9008