

PHILIPS

CoreLine



Innovative



Easy to install



High quality



In a state or **state-of-the-art?**

Real professionals choose **Philips CoreLine** for every project
where light really matters

**REAL
PROs**
**REAL
QUALITY**



Find out why real pros
rely on **Philips CoreLine:**
the full range of **innovative**
high quality and
easy-to-use LED lighting
solutions for every project
where light really
matters.



4

Introduction

6

Discover what sets CoreLine apart
See why CoreLine is raising the bar in the industry.

8

The complete CoreLine range
Discover every CoreLine product available today.



Now with
5 years
warranty!

28

Overview CoreLine and
Interact Ready products

Get the full specifications for
every product.



34

Overview CoreLine
accessories



35

CoreLine website

Go online for a complete
CoreLine resource.



**REAL
PROs**
**REAL
QUALITY**



Lower standards or raise the bar?

Smart installers never say “no” to saving time and money. And with Philips CoreLine, they will never have to. Because Philips CoreLine offers a full range of LED lighting solutions that keep installation time to a minimum, while saving a maximum of energy. Whether old or new – optimal lighting can transform a building into something truly special and turn it into a place where people enjoy working and living. Give your customers that “wow” moment with Philips CoreLine: the complete range of high quality LED lighting that’s setting the reference in the market. **Because when light really matters, you don’t want to take a chance.**

www.philips.com/coreline

Reliable quality meets
innovative solutions!



Easy-to-install

The efficient design of the CoreLine fixtures enables replacement of existing lights, with **no need for expensive re-wiring or new ceiling configurations.**



Innovative

With **Philips CoreLine** you get much more than high quality and easy-to-install lighting solutions – you get LED lighting that's setting **the reference** in the industry. That's why CoreLine luminaires are the first Interact Ready LED luminaires and work seamlessly with the **intuitive Interact Pro app and dashboard**. It has never been easier to bring the power of connected lighting to small and medium-sized enterprises.

How the connected lighting system comes together



High quality

At the heart of CoreLine's **high-quality light** is LED technology. Lasting up to 75,000 hours, its **long lifetime** enables you to meet every demand and provide the best lighting solution for every customer.

CoreLine.

The complete range.



CoreLine **batten***



CoreLine **downlight****



CoreLine **grid light**



CoreLine **projector**



CoreLine **recessed luminaire***



CoreLine **recessed spot**



CoreLine **wall-mounted luminaire***

interact ready.



CoreLine **waterproof***



CoreLine **bollard**

Now with
5
years
warranty!



CoreLine **highbay***



New

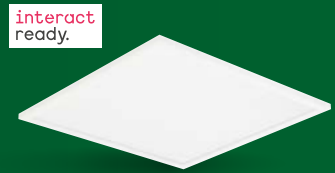

CoreLine **panel***



CoreLine **slim downlight**



CoreLine **surface-mounted luminaire***



CoreLine **trunking***



CoreLine **malaga**



CoreLine **tempo**

New: CoreLine Interact Ready luminaires!
Discover more on page 32

* DALI and Emergency versions available

** IP54, DALI and Emergency versions available

CoreLine batten



Features

- Lifetime: 50,000 hours L70
- Through-wiring standard included
- DALI and emergency lighting options available

Benefits

- Easy to install and lengths same as TL-D
- Excellent performance and light quality thanks to frosted diffuser



Application

General lighting / assembly lines / cove lighting

BN124C



BN124C L600

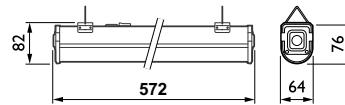

BN124C L1200

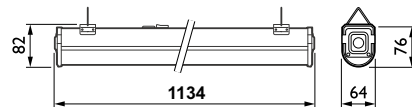

BN124C L1500

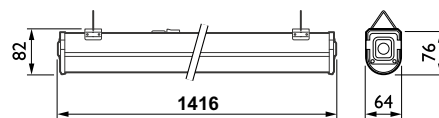

Integrated LED technology



Ceiling mounted bracket included



Easy installation without removing the cover

CoreLine downlight



interact
ready.



Features

- Lifetime: 50,000 hours L70
- Energy-efficient: up to 115 lm/W
- Available in 1100 and 2200 lumen versions
- DALI option available
- Choice of color temperature: 3000 and 4000K
- Driver failure <5%
- IP54, DALI and emergency lighting options available

Benefits

- **Covers a wide range of professional applications** thanks to DALI dimming options and different optics (white and high gloss reflector)
- **Interact Ready version:** integrated wireless antenna for use with **Interact Pro** app and dashboard



Application

General lighting in corridors / retail stores / reception areas / indoor circulation areas

DN140B mini



DN140B mini



DN140B compact



White reflector

DN140B compact



High gloss reflector

150mm white reflector

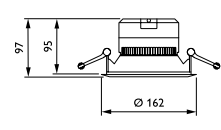

150mm high gloss reflector + IP54

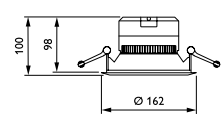

200mm white reflector

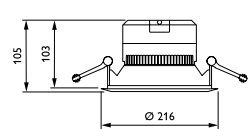

200mm high gloss reflector + IP54

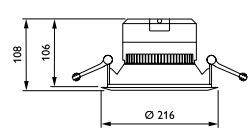

CoreLine grid light



Features

- Available in single, double and triple spot
- Connectable to high performance light sources of CoreLine Recessed Spot
- Dimming driver works with most wall-mounted dimmers
- Adjustable light sources, 360 degrees rotational and 20 degree tilting angle

Benefits

- Slim design fits most ceiling types
- High-end materials for decorative applications
- Easy to install thanks to push-in connectors



Application

Retail stores / hospitality areas / reception areas / restaurants

RS145Z CFRM GRID 1×1 WH

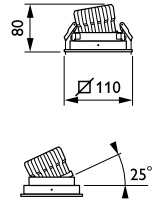
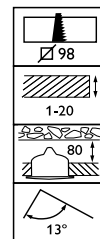

RS145Z CFRM GRID 1×2 WH

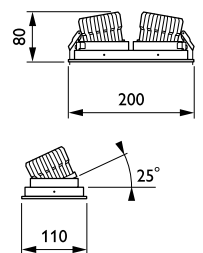
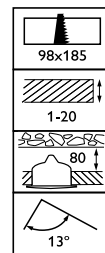

RS145Z CFRM GRID 1×3 WH

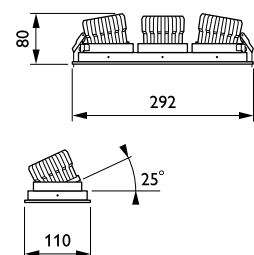
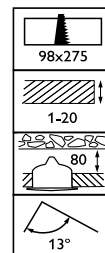

CoreLine highbay



With integrated PIR sensor for additional savings of up to 20 %



Features

- Lifetime: 50,000 hours L70
- Energy efficient: up to 132 lm/W
- Consistent color rendering (CRI = 80) in compliance with EN-12464-1
- Point-for-point replacement of 250W and 400W conventional HPI highbays
- DALI and emergency lighting options available
- Motion detector for automatized dimming
- Minimum dimming level is fixed at 25%
- Max. height 13m, Max. diameter 10m

Benefits

- Easy to install due to hook mounting and external IP65 connector
- Lens optics for good optical distribution, effective glare control
- Wide detection area for the sensor to optimize coverage



Application

Warehouses / industry / major halls / supermarkets

BY120P



BY121P



BY120P

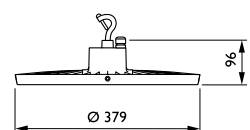
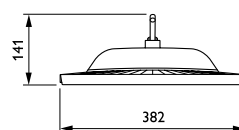

BY121P

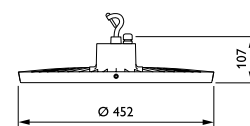
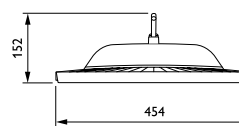

BY120P G3



BY121P G3



BY120P G3

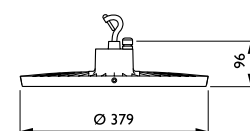
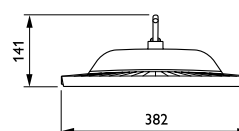

BY121P G3

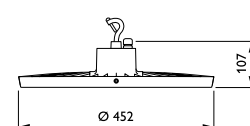
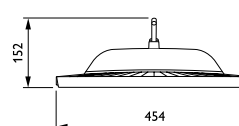

CoreLine highbay

New



Features

- Lifetime: 70,000 hrs at L70
- High efficiency of up to 140 lm/W
- Low glare rating and color rendering of >80
- Single point mounting system for simple installation
- Suitable for replacement of 250W/400W conventional highbays

Benefits

- High-quality visibility and application uniformity with low glare
- Robust and reliable solutions for long service life
- Highly efficient solutions with an attractive total cost of ownership
- Dedicated lens optics (NB/WB) to meet all application requirements
- Innovative product design with the option of seamlessly integrating sensors into the product



Application

Warehouses / logistical centers / manufacturing areas / exhibition halls / high ceiling lounges

BY120P

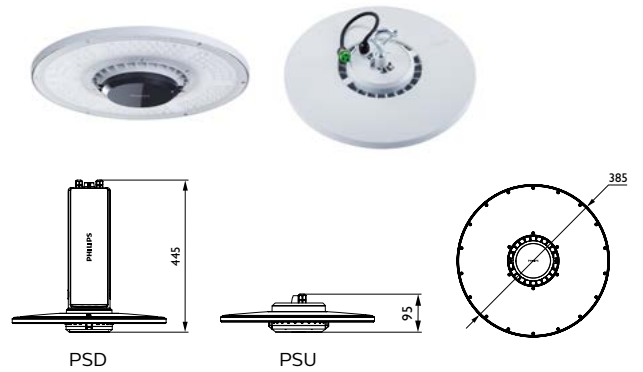

BY121P

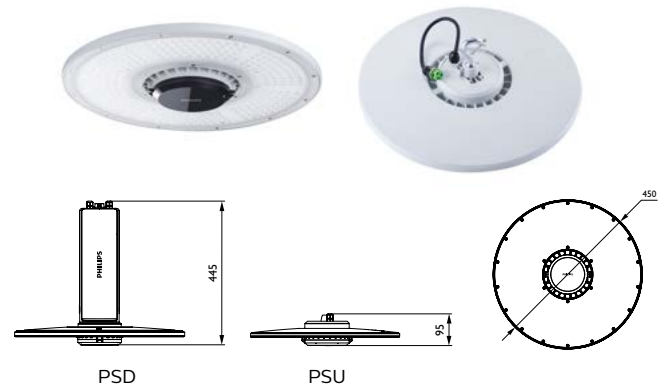

BY122P

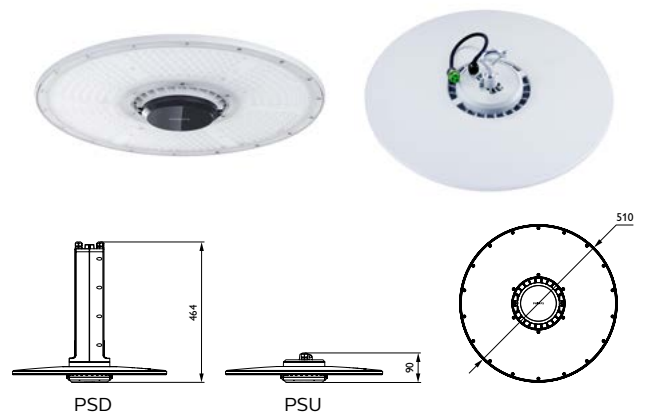

CoreLine panel



interact
ready.



Features

- Lifetime: 50,000 hours L75
- Energy efficient: 110 lm/W
- Slim and robust housing made from aluminum
- Choice of two color temperatures: 3000 and 4000K
- Office compliant (OC) and non-office compliant (NOC) version available
- Recessed, surface mounted and suspended applications
- DALI and emergency lighting options available
- Suspension possible with accessory suspension set

Benefits

- **Metal frame for better robustness**
- **Easy connection** (with looping)
- **Flicker-free** thanks to high-performance driver
- **Interact Ready version:** integrated wireless antenna for use with **Interact Pro** app and dashboard



Application

General lighting

RC125B, RC127V,
RC132V W60L60



RC132V W30L60 NOC



RC127V, RC132V W30L120



All types



RC132V PSU W60L60

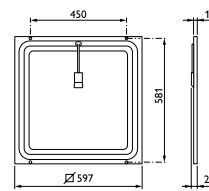

RC132V PSU W30L60 NOC

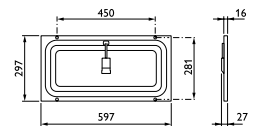

RC132V PSD, RC125B, RC127V



RC132V PSU W30L120

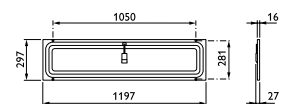

See page 33 for available accessories

CoreLine projector



Features

- Lifetime: 50,000 hours L70
- Energy efficient: up to 90 lm/W
- Smooth black finish with matt aluminum swivel
- Medium beam (23D) or wide beam angle (36D) available

Benefits

- **Modern design that blends in to most interiors**
- Direct replacement of traditional CDM projectors
- Connectable to standard 3C track systems



Application

Independent bakery / independent butcher /
small grocery store / small fashion shops

ST150T

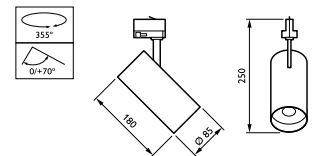

Recessed lens providing visual comfort



CoreLine recessed luminaire



interact
ready.

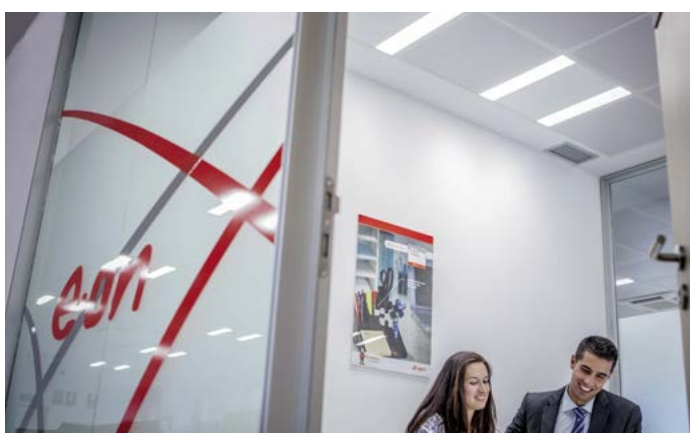

Features

- Lifetime: 50,000 hours L70
- Slim design with a height of less than 41 mm
- Surface-mounted version also available (also suitable for suspension)
- Office compliant (OC) and non-office compliant (NOC) version available
- DALI and emergency lighting options available
- Suitable for plaster ceiling installation

Benefits

- **Easy connection** (with looping)
- **Flicker-free** thanks to high performance driver
- **Interact Ready version:** integrated wireless antenna for use with **Interact Pro** app and dashboard



Application

General lighting

See page 33 for available accessories.

RC134B W60L60



RC134B W30L120



RC134B W60L60

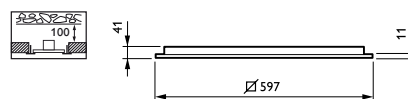

RC134B W30L120

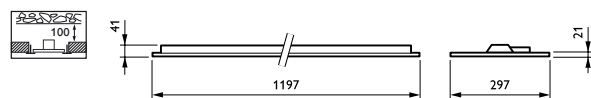

CoreLine recessed spot

With chip-on-Board
(COB) technology

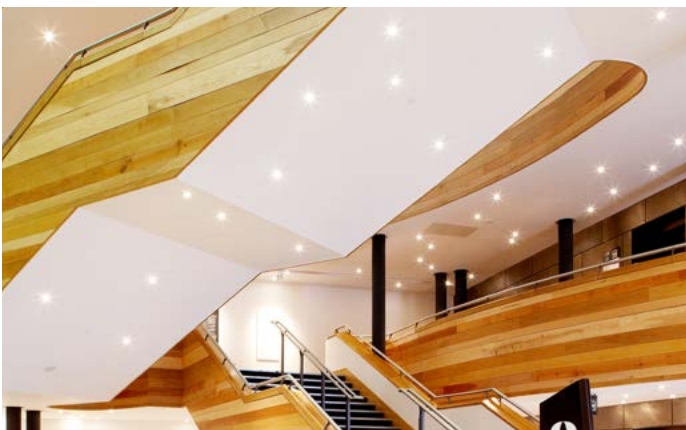

Features

- Lifetime: 50,000 hours L70
- Available in fixed and adjustable versions
- Different finishes and frames available
- Multiple rims available in white, aluminium and black
- Available in three light levels; 650 lumen (standard halogen), 900 lumen and 1200 lumen
- Slim design; smaller than 60 mm
- Push-in connector with through-wiring option

Benefits

- **High-end materials** for decorative applications and **special anti-glare optics**
- **80% energy saving** and **15 × longer lifetime** compared to halogen luminaire
- **Slim design fits most ceiling types**
- **Dimming driver works with 99 % of wall-mounted dimmers**
- **Flicker-free** thanks to **high performance driver with tested dimming function**



Application

Reception areas / decorative applications /
retail stores / corridor

RS141B Round adjustable WH



RS140B Round fixed WH



Round adjustable ALU



RS140B Round fixed ALU



Square adjustable WH



FR Fire-rated (30-60-90 min)



RS141B-LD

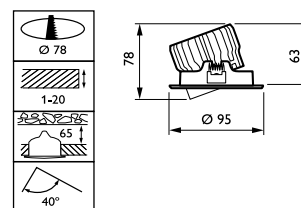

Modular product with
many different rim designs

CoreLine slim downlight



interact
ready.



Features

- Lifetime: 50,000 hours L70
- Available in 1000 and 2000 lumen versions
- Recessed and surface mounted version
- Choice of color temperature: 3000 and 4000K
- Recessed and surface-mounted versions enables luminaire to be positioned anywhere

Benefits

- **Fits more ceiling types** thanks to product height of less than 50 mm
- The **natural 'surface of light' effect** creates a comfortable, high-end look
- **Interact Ready version:** integrated wireless antenna for use with **Interact Pro** app and dashboard

Application

General lighting in corridors / retail stores / reception areas / indoor circulation areas

DN135B LED10S



DN135B LED20S



Slim downlight recessed

DN135B LED6S



DN135C LED20S



Surface mounted versions available in 150 and 200 diameter

DN135B LED10S

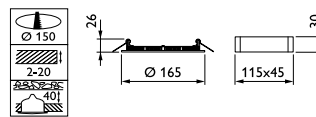

DN135B LED20S

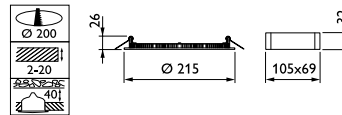

DN135B LED6S

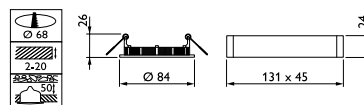

DN135C LED10S

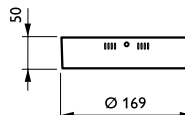

DN135C LED20S

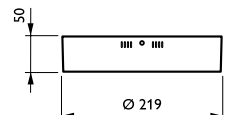

CoreLine surface-mounted luminaire



interact
ready.



Features

- Lifetime: 50,000 hours L70
- Suspension set available as an accessory
- Recessed version also available for use in grid ceilings
- DALI and emergency lighting options available
- Slim design and <47 mm height

Benefits

- **Easy connection** (with looping)
- **Interact Ready version:** integrated wireless antenna for use with **Interact Pro** app and dashboard



Application

General lighting

See page 33 for available accessories.

SM134V W60L60

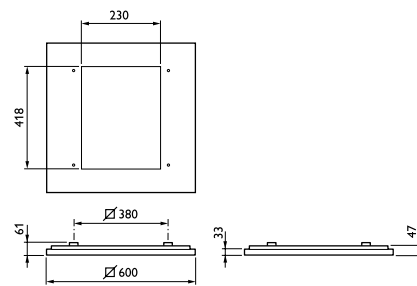

SM134V W20L120

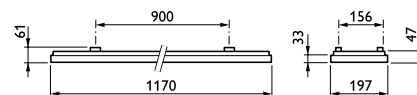

CoreLine trunking



LL120X/LL121X



LL120X TW3 KIT

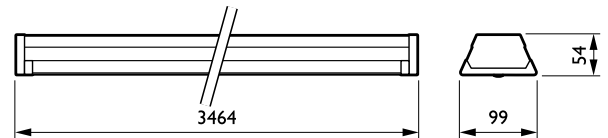

Features

- Lifetime: 50,000 hours L80
- Highly efficient and reliable LED boards
- Advanced optics enable precise and energy-saving beam shapes
- Only two 12 NC codes needed to make a light line
- DALI and emergency lighting options available

Benefits

- **Reduced maintenance and best lumens per € solution**
- **Excellent beam shapes** and sparkle for product enhancement



Application

Supermarkets / warehouses / assembly areas

CoreLine wall-mounted luminaire



Features

- Lifetime: 50,000 hours L70
- Three lumen packages to cater for diverse applications
- Water- and vandal-proof as standard
- Optional emergency lighting (incl. self-test)
- Optional motion detector, including daylight sensing, dimming and grouping function
- DALI and emergency lighting options available

Benefits

- **Easy installation** with push-in connectors and looping-wire option
- **Slim and unobtrusive design**
- **Homogeneous light effect** to cater for visual comfort



Application

Corridors / staircases / entrance areas / restrooms / parking garages

WL130V

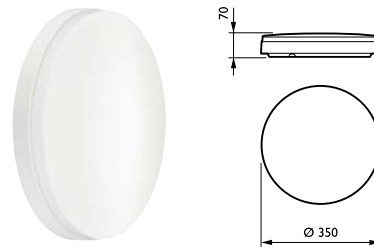

WL131V

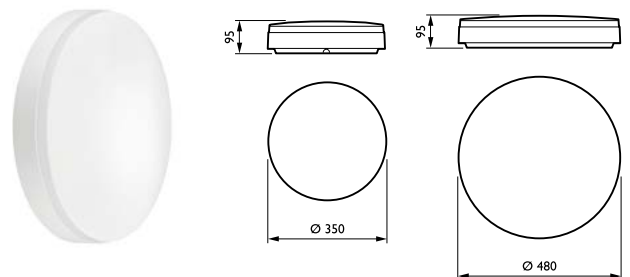

CoreLine waterproof



Most complete range of waterproof luminaires!

interact
ready.



Features

- Lifetime: 50,000 hours L75
- Wide-beam light distribution
- Available in three lengths: 600 mm, 1200 mm and 1500 mm
- Ceiling-mounted bracket and suspension hooks included
- Vandal-proof by additional screw fixation of mounting brackets
- High performance DALI driver
- IP65 and IK08 rated

Benefits

- Covers **wide range of applications** thanks to **extensive choice of options** (advanced optic, ENEC, DALI, emergency, through wiring, WEC)
- **Easy to install and handle:** through wiring and WEC connectors, luminaire lengths are the same as TL-D
- **Diffuser with optical element ensures visual comfort**
- **Excellent performance and sleek design**
- **Interact Ready version:** integrated wireless antenna for use with **Interact Pro** app and dashboard



Application

Parking garages / warehouses / general lighting

WT120C L600

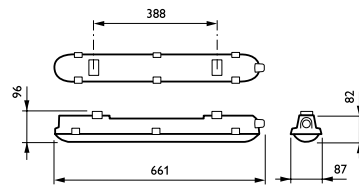

WT120C L1200

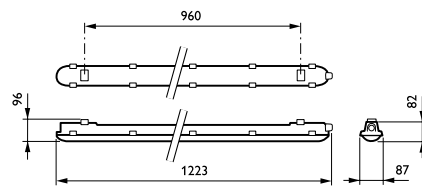

WT120C L1500

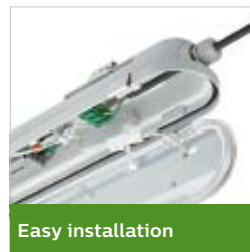
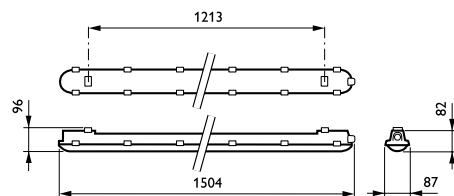

Easy installation



Ceiling bracket and anti-vandal screws

CoreLine bollard



Features

- Lifetime: 50,000 hours L70
- 1000 lm, available with symmetric and asymmetric optic
- Available in warm white and neutral white
- 1m height
- IP65 and IK08 rated
- Supplied with cable and connector

Benefits

- **Comfortable light**
- **Easy to install**
- **Saves energy** compared to conventional lamps



Application

Residential areas / parks and garden /
outdoor car parks / building fronts



BCP 155

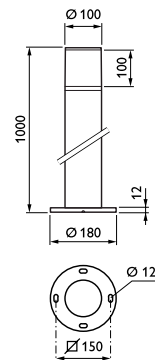

ZCP 150

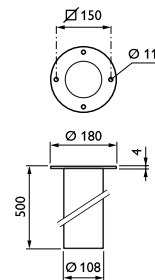

CoreLine malaga



Features

- Lifetime: 100,000 hours L70
- Integrated LED-module
- Color temperature: 4000K
- CRI: ≥ 70
- Post top adapter separately available
- IP65 and IK08 rated

Benefits

- **Reliable quality:** aluminum die-cast housing and tempered flat glass
- **Fast return on investment because no lamp replacement needed**
- **Easy to repair thanks to the Philips service tag**
- **Energy savings of 50%**



Application

General outdoor / road / street and residential areas / industrial areas or parking lots / public transport such as bus or tramway stops

small



medium

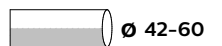
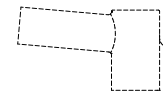
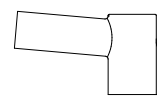
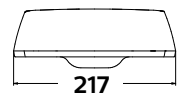
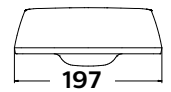
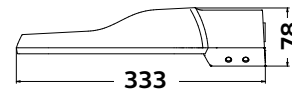

CoreLine tempo



Features

- Lifetime: 75,000 hours L80
- Energy efficient: up to 130 lm/W
- High-performance asymmetrical and symmetrical optics
- U-shaped universal mounting bracket and external quick 3-pole
- IP65 and IK08 rated
- High surge protection : 6 kV/8kV
- Options: 3000K CCT, DALI control and harsh environment coatings

Benefits

- **Point-to-point replacement** up to 400W conventional HPI-TP floodlights
- **Reliable quality:** Die-casting aluminum housing guarantees robustness, vibration-proof, wind force protection



Application

Area lighting / industrial areas / parking lots / recreational sports facilities / building facades

BVP110

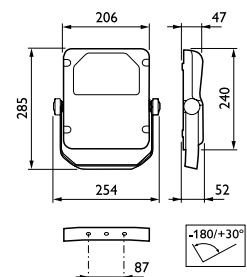

BVP125

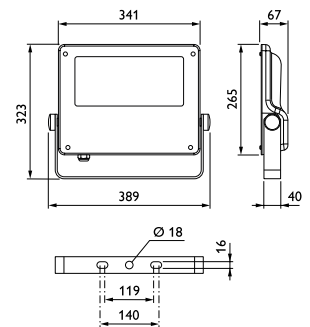

BVP130

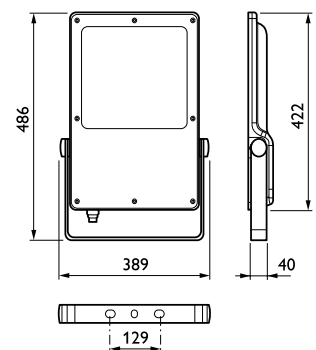

Fit the rest or **fit the best?**

The CoreLine range of LED luminaires offers a lighting solution for every taste and task. Get the full specifications for every product here and find just what you need to get the job done.

Industry

- Hard-working lighting with costs and safety in mind
- Lighting that works harder while saving more
- Durable, cost-effective for more safety & health

Innovative quality meets large scale energy-savings and ease of installation:
www.philips.com/coreline

Office

- Productivity-enhancing lighting that people like working in
- Lighting that optimizes space and productivity
- Smart, optimal lighting for more productivity and well-being

Parking

- Robust lighting that heightens safety while lowering costs
- Lighting that puts safety and convenience first
- Tough, safety-first lighting for more visibility and savings







Retail

- Welcoming lighting that keeps customers coming back
- Lighting that enhances the shopping experience
- Warm, inviting lighting for more sales & satisfaction

Outdoor



- Save energy and improve road safety
- Reduce CO₂ emissions for a greener, more sustainable city
- Connect new and existing street lights quickly and easily

Overview CoreLine indoor products

CoreLine	Wattage	Lifetime	Luminous Flux	Color Temp.	CRI	Product description	EOC code
CoreLine batten* 	19 W	L70 at 50,000 hrs	2100 lm	4000K	≥ 80	BN124C LED21S/840 PSU TW1 L600	07472599
	19 W	L70 at 50,000 hrs	1900 lm	3000K	≥ 80	BN124C LED19S/830 PSU TW1 L600	07473299
	38 W	L70 at 50,000 hrs	4100 lm	4000K	≥ 80	BN124C LED41S/840 PSU TW1 L1200	07474999
	38 W	L70 at 50,000 hrs	3800 lm	3000K	≥ 80	BN124C LED38S/830 PSU TW1 L1200	38000799
	60 W	L70 at 50,000 hrs	6400 lm	4000K	≥ 80	BN124C LED64S/840 PSU TW1 L1500	38001499
	60 W	L70 at 50,000 hrs	6000 lm	3000K	≥ 80	BN124C LED60S/830 PSU TW1 L1500	38002199
CoreLine downlight** 	9.5 W	L70 at 50,000 hrs	1100 lm	3000K	≥ 80	DN140B LED10S/830 PSU WR P16	32580400
	9.5 W	L70 at 50,000 hrs	1100 lm	4000K	≥ 80	DN140B LED10S/840 PSU WR P16	32581100
	19 W	L70 at 50,000 hrs	2200 lm	3000K	≥ 80	DN140B LED20S/830 PSU WR P16	32584200
	19 W	L70 at 50,000 hrs	2200 lm	4000K	≥ 80	DN140B LED20S/840 PSU WR P16	32585900
	9.5 W	L70 at 50,000 hrs	1100 lm	3000K	≥ 80	DN140B LED10S/830 PSU C P16	32588000
	9.5 W	L70 at 50,000 hrs	1100 lm	4000K	≥ 80	DN140B LED10S/840 PSU C P16	32589700
	19 W	L70 at 50,000 hrs	2200 lm	3000K	≥ 80	DN140B LED20S/830 PSU C P16	32592700
	19 W	L70 at 50,000 hrs	2200 lm	4000K	≥ 80	DN140B LED20S/840 PSU C P16	32593400
CoreLine grid light 	n/a	n/a	n/a	n/a	n/a	RS145Z CFRM GRID 1x1 WH	38832499
	n/a	n/a	n/a	n/a	n/a	RS145Z CFRM GRID 1x2 WH	38833199
	n/a	n/a	n/a	n/a	n/a	RS145Z CFRM GRID 1x3 WH	38834899
CoreLine highbay*  	155 W	L70 at 50,000 hrs	20,500 lm	4000K	≥ 80	BY121P G3 LED205S/840 PSU WB GR	30145700
	155 W	L70 at 50,000 hrs	20,500 lm	4000K	≥ 80	BY121P G3 LED205S/840 PSD WB GR	30147100
	155 W	L70 at 50,000 hrs	20,500 lm	6500K	≥ 80	BY121P G3 LED205S/865 PSU WB GR	331713700
	85 W	L70 at 50,000 hrs	10,500 lm	4000K	≥ 80	BY120P G3 LED105S/840 PSU WB GR	30144000
	85 W	L70 at 50,000 hrs	10,500 lm	4000K	≥ 80	BY120P G3 LED105S/840 PSD WB GR	30146400
	85 W	L70 at 50,000 hrs	10,500 lm	6500K	≥ 80	BY120P G3 LED105S/865 PSU WB GR	331712000
	n/a	n/a	n/a	n/a	n/a	BY121Z G3 MB	30149500
	n/a	n/a	n/a	n/a	n/a	BY120Z G3 MB	30148800
	68 W	L70 at 70,000 hrs	10,000 lm	4000K	≥ 80	BY120P G4 LED100S/840 PSU NB	333571100
	68 W	L70 at 70,000 hrs	10,000 lm	4000K	≥ 80	BY120P G4 LED100S/840 PSU WB	33570400
	135 W	L70 at 70,000 hrs	20,500 lm	4000K	≥ 80	BY121P G4 LED200S/840 PSU NB	33569800
	135 W	L70 at 70,000 hrs	20,500 lm	4000K	≥ 80	BY121P G4 LED200S/840 PSU WB	33568100
	169 W	L70 at 70,000 hrs	25,000 lm	4000K	≥ 80	BY122P G4 LED250S/840 PSU NB	33664000
	169 W	L70 at 70,000 hrs	25,000 lm	4000K	≥ 80	BY122P G4 LED250S/840 PSU WB	33665700
	68 W	L70 at 70,000 hrs	10,000 lm	4000K	≥ 80	BY120P G4 LED100S/840 PSD NB	33702900
	68 W	L70 at 70,000 hrs	10,000 lm	4000K	≥ 80	BY120P G4 LED100S/840 PSD WB	33703600
	135 W	L70 at 70,000 hrs	20,500 lm	4000K	≥ 80	BY121P G4 LED200S/840 PSD NB	33698500
	135 W	L70 at 70,000 hrs	20,500 lm	4000K	≥ 80	BY121P G4 LED200S/840 PSD WB	33699200
	169 W	L70 at 70,000 hrs	25,000 lm	4000K	≥ 80	BY122P G4 LED250S/840 PSD NB	33879800
	169 W	L70 at 70,000 hrs	25,000 lm	4000K	≥ 80	BY122P G4 LED250S/840 PSD WB	33880400
CoreLine highbay integrated sensor* 	155 W	L70 at 50,000 hrs	20,500 lm	4000K	≥ 80	BY121P G3 LED205S/840 PIR WB GR	331714400
	155 W	L70 at 50,000 hrs	20,500 lm	6500K	≥ 80	BY121P G3 LED205S/865 PIR WB GR	331715100
	85 W	L70 at 50,000 hrs	10,500 lm	4000K	≥ 80	BY120P G3 LED105S/840 PIR WB GR	331716800
	85 W	L70 at 50,000 hrs	10,500 lm	6500K	≥ 80	BY120P G3 LED105S/865 PIR WB GR	331717500
CoreLine panel* 	34 W	L75 at 50,000 hrs	3600 lm	4000K	≥ 80	RC132V LED36S/840 PSU W60L60 NOC	38095300
	34 W	L75 at 50,000 hrs	3400 lm	3000K	≥ 80	RC132V LED34S/830 PSU W60L60 NOC	38614600
	34 W	L75 at 50,000 hrs	3600 lm	4000K	≥ 80	RC133V LED36S/840 PSU W62L62 NOC	38615300
	34 W	L75 at 50,000 hrs	3400 lm	3000K	≥ 80	RC133V LED34S/830 PSU W62L62 NOC	38616000
	34 W	L75 at 50,000 hrs	3600 lm	4000K	≥ 80	RC132V LED36S/840 PSU W60L60 OC	38098400
	34 W	L75 at 50,000 hrs	3400 lm	3000K	≥ 80	RC132V LED34S/830 PSU W60L60 OC	38099100
	34 W	L75 at 50,000 hrs	3600 lm	4000K	≥ 80	RC132V LED36S/840 PSU W30L120 OC	38102800
	34 W	L75 at 50,000 hrs	3400 lm	3000K	≥ 80	RC132V LED34S/830 PSU W30L120 OC	38103500
	34 W	L75 at 50,000 hrs	3600 lm	4000K	≥ 80	RC132V LED36S/840 PSD W60L60 OC	38608500
	34 W	L75 at 50,000 hrs	3400 lm	3000K	≥ 80	RC132V LED34S/830 PSD W60L60 OC	38609200
	34 W	L75 at 50,000 hrs	3600 lm	4000K	≥ 80	RC132V LED36S/840 PSU W60L60 NOC	38095300
	34 W	L75 at 50,000 hrs	3400 lm	3000K	≥ 80	RC132V LED34S/830 PSU W60L60 NOC	38614600
	34 W	L75 at 50,000 hrs	3600 lm	4000K	≥ 80	RC133V LED36S/840 PSU W62L62 NOC	38615300
	34 W	L75 at 50,000 hrs	3400 lm	3000K	≥ 80	RC133V LED34S/830 PSU W62L62 NOC	38616000

New
New
New
New
New
New
New
New
New
New
New





CoreLine – an LED light for every need

CoreLine	Wattage	Lifetime	Luminous Flux	Color Temp.	CRI	Product description	EOC code
CoreLine panel*	34 W	L75 at 50,000 hrs	3600 lm	4000K	≥ 80	RC132V LED36S/840 PSD W30L120 OC	38612200
	34 W	L75 at 50,000 hrs	3400 lm	4000K	≥ 80	RC132V LED34S/830 PSD W30L120 OC	38613900
	34 W	L75 at 50,000 hrs	3600 lm	4000K	≥ 80	RC133V LED36S/840 PSU W62L62 OC	38100400
	34 W	L75 at 50,000 hrs	3400 lm	4000K	≥ 80	RC133V LED34S/830 PSU W62L62 OC	38101100
	34 W	L75 at 50,000 hrs	3600 lm	3000K	≥ 80	RC133V LED36S/840 PSD W62L62 OC	38610800
	34 W	L75 at 50,000 hrs	3400 lm	4000K	≥ 80	RC133V LED34S/830 PSD W62L62 OC	38611500
	18 W	L75 at 50,000 hrs	1800 lm	3000K	≥ 80	RC132V LED18S/840 PSU W30L60 NOC	38096000
	34 W	L75 at 50,000 hrs	3600 lm	4000K	≥ 80	RC132V LED36S/840 PSU W30L120 NOC	38097700
CoreLine projector 	24 W	L70 at 50,000 hrs	2200 lm	3000K	≥ 80	ST150T LED22S-23-/830 PSU BK	79067799
	24 W	L70 at 50,000 hrs	2200 lm	4000K	≥ 80	ST150T LED22S-23-/840 PSU BK	79068499
	24 W	L70 at 50,000 hrs	2200 lm	3000K	≥ 80	ST150T LED22S-23-/830 PSU WH	79069199
	24 W	L70 at 50,000 hrs	2200 lm	4000K	≥ 80	ST150T LED22S-23-/840 PSU WH	79070799
	24 W	L70 at 50,000 hrs	2200 lm	3000K	≥ 80	ST150T LED22S-36-/830 PSU BK	79071499
	24 W	L70 at 50,000 hrs	2200 lm	4000K	≥ 80	ST150T LED22S-36-/840 PSU BK	79072199
	24 W	L70 at 50,000 hrs	2200 lm	3000K	≥ 80	ST150T LED22S-36-/830 PSU WH	79073899
	24 W	L70 at 50,000 hrs	2200 lm	4000K	≥ 80	ST150T LED22S-36-/840 PSU WH	79074599
CoreLine recessed luminaire* 	34 W	L75 at 50,000 hrs	3700 lm	4000K	≥ 80	RC134B LED37S/840 PSU W60L60 NOC	34817500
	27 W	L75 at 50,000 hrs	2700 lm	4000K	≥ 80	RC134B LED27S/840 PSU W60L60 NOC	34823600
	34 W	L75 at 50,000 hrs	3700 lm	4000K	≥ 80	RC134B LED37S/840 PSU W30L120 NOC	34818200
	27 W	L75 at 50,000 hrs	2700 lm	4000K	≥ 80	RC134B LED27S/840 PSU W30L120 NOC	34824300
	30.5 W	L75 at 50,000 hrs	3700 lm	4000K	≥ 80	RC134B LED37S/840 PSU W60L60 OC	34829800
	30.5 W	L75 at 50,000 hrs	3700 lm	4000K	≥ 80	RC134B LED37S/840 PSU W30L120 OC	34830400
	34.5 W	L75 at 50,000 hrs	3700 lm	3000K	≥ 80	RC134B LED37S/830 PSU W60L60 OC	34831100
	34.5 W	L75 at 50,000 hrs	3700 lm	3000K	≥ 80	RC134B LED37S/830 PSU W30L120 OC	34832800
	31.5 W	L75 at 50,000 hrs	3700 lm	4000K	≥ 80	RC134B LED37S/840 PSD W60L60 OC	34804500
	31.5 W	L75 at 50,000 hrs	3700 lm	4000K	≥ 80	RC134B LED37S/840 PSD W30L120 OC	34811300
	31.5 W	L75 at 50,000 hrs	3700 lm	3000K	≥ 80	RC134B LED37S/830 PSD W60L60 OC	34813700
	31.5 W	L75 at 50,000 hrs	3700 lm	3000K	≥ 80	RC134B LED37S/830 PSD W30L120 OC	34815100
	CoreLine recessed spot 	8 W	L70 at 50,000 hrs	650 lm	2700K	≥ 80	RS140B LED6-32-/827 PSR P16 WH
8 W		L70 at 50,000 hrs	650 lm	3000K	≥ 80	RS140B LED6-32-/830 PSR P16 WH	38278099
8 W		L70 at 50,000 hrs	650 lm	4000K	≥ 80	RS140B LED6-32-/840 PSR P16 WH	38279799
8 W		L70 at 50,000 hrs	650 lm	2700K	≥ 80	RS140B LED6-32-/827 PSR P16 ALU	38287299
8 W		L70 at 50,000 hrs	650 lm	3000K	≥ 80	RS140B LED6-32-/830 PSR P16 ALU	38288999
8 W		L70 at 50,000 hrs	650 lm	4000K	≥ 80	RS140B LED6-32-/840 PSR P16 ALU	38289699
8 W		L70 at 50,000 hrs	650 lm	2700K	≥ 80	RS141B LED6-32-/827 PSR P16 WH	38280399
8 W		L70 at 50,000 hrs	650 lm	3000K	≥ 80	RS141B LED6-32-/830 PSR P16 WH	38281099
8 W		L70 at 50,000 hrs	650 lm	4000K	≥ 80	RS141B LED6-32-/840 PSR P16 WH	38282799
8 W		L70 at 50,000 hrs	650 lm	2700K	≥ 80	RS141B LED6-32-/827 PSR P16 ALU	38290299
8 W		L70 at 50,000 hrs	650 lm	3000K	≥ 80	RS141B LED6-32-/830 PSR P16 ALU	38291999
8 W		L70 at 50,000 hrs	650 lm	4000K	≥ 80	RS141B LED6-32-/840 PSR P16 ALU	38292699
8 W		L70 at 50,000 hrs	1200 lm	2700K	≥ 80	RS140B LED6-32-/827 PSR P16 WH FR	38417399
8 W		L70 at 50,000 hrs	1200 lm	3000K	≥ 80	RS140B LED6-32-/830 PSR P16 WH FR	38418099
11 W		L70 at 50,000 hrs	900 lm	3000K	≥ 80	RS141B LED9-32-/830 PSR P16 WH	38283499
11 W		L70 at 50,000 hrs	900 lm	4000K	≥ 80	RS141B LED9-32-/840 PSR P16 WH	38284199
11 W		L70 at 50,000 hrs	900 lm	3000K	≥ 80	RS140B LED9-32-/830 PSR P16 WH	38285899
11 W		L70 at 50,000 hrs	900 lm	4000K	≥ 80	RS140B LED9-32-/840 PSR P16 WH	38286599
11 W		L70 at 50,000 hrs	900 lm	3000K	≥ 80	RS140B LED9-32-/830 PSR P16 ALU	38293399
11 W		L70 at 50,000 hrs	900 lm	4000K	≥ 80	RS140B LED9-32-/840 PSR P16 ALU	38294099
14.5 W	L70 at 50,000 hrs	1200 lm	3000K	≥ 80	RS141B LED12-36-/830 PSR P16 WH	38419799	
14.5 W	L70 at 50,000 hrs	1200 lm	4000K	≥ 80	RS141B LED12-36-/840 PSR P16 WH	38420399	







* DALI and Emergency versions available

** IP54, DALI and Emergency versions available

Overview CoreLine indoor products

CoreLine	Wattage	Lifetime	Luminous Flux	Color Temp.	CRI	Product description	EOC code	
CoreLine slim downlight 	13 W	L70 at 50,000 hrs	1000 lm	3000K	≥ 80	DN135B LED10S/830 PSU II WH	07042099	
	13 W	L70 at 50,000 hrs	1000 lm	4000K	≥ 80	DN135B LED10S/840 PSU II WH	07043799	
	28 W	L70 at 50,000 hrs	2000 lm	3000K	≥ 80	DN135B LED20S/830 PSU II WH	07044499	
	28 W	L70 at 50,000 hrs	2000 lm	4000K	≥ 80	DN135B LED20S/840 PSU II WH	07045199	
	13 W	L70 at 50,000 hrs	1000 lm	3000K	≥ 80	DN135C LED10S/830 PSU II WH	07046899	
	13 W	L70 at 50,000 hrs	1000 lm	4000K	≥ 80	DN135C LED10S/840 PSU II WH	07047599	
	28 W	L70 at 50,000 hrs	2000 lm	3000K	≥ 80	DN135C LED20S/830 PSU II WH	07048299	
	28 W	L70 at 50,000 hrs	2000 lm	4000K	≥ 80	DN135C LED20S/840 PSU II WH	07049999	
	CoreLine surface-mounted luminaire* 	34 W	L75 at 50,000 hrs	3700 lm	4000K	≥ 80	SM134V LED37S/840 PSU W60L60 NOC	34869400
27 W		L75 at 50,000 hrs	2700 lm	4000K	≥ 80	SM134V LED27S/840 PSU W60L60 NOC	34875500	
34 W		L75 at 50,000 hrs	3700 lm	4000K	≥ 80	SM134V LED37S/840 PSU W20L120 NOC	34870000	
27 W		L75 at 50,000 hrs	2700 lm	4000K	≥ 80	SM134V LED27S/840 PSU W20L120 NOC	34876200	
30.5 W		L75 at 50,000 hrs	3700 lm	4000K	≥ 80	SM134V LED37S/840 PSU W60L60 OC	34881600	
34.5 W		L75 at 50,000 hrs	3700 lm	3000K	≥ 80	SM134V LED37S/830 PSU W60L60 OC	34883000	
30.5 W		L75 at 50,000 hrs	3700 lm	4000K	≥ 80	SM134V LED37S/840 PSU W20L120 OC	34882300	
34.5 W		L75 at 50,000 hrs	3700 lm	3000K	≥ 80	SM134V LED37S/830 PSU W20L120 OC	34884700	
31.5 W		L75 at 50,000 hrs	3700 lm	4000K	≥ 80	SM134V LED37S/840 PSD W60L60 OC	34861800	
31.5 W		L75 at 50,000 hrs	3700 lm	3000K	≥ 80	SM134V LED37S/830 PSD W60L60 OC	34865600	
31.5 W		L75 at 50,000 hrs	3700 lm	4000K	≥ 80	SM134V LED37S/840 PSD W20L120 OC	34863200	
31.5 W		L75 at 50,000 hrs	3700 lm	3000K	≥ 80	SM134V LED37S/830 PSD W20L120 OC	34867000	
CoreLine trunking* 		106 W (3.4 m)	L80 at 70,000 hrs	4000 lm	4000K	≥ 80	LL120X LED160S/840 2x PSD WB 7 WH	96380871
		64 W (3.4 m)	L80 at 70,000 hrs	to 7000 lm	4000K	≥ 80	LL120X LED90S/840 PSU DA20 5 WH	88184100
	54 W (1.7 m)	L80 at 70,000 hrs	(per 1.5m)	4000K	≥ 80	LL121X LED80S/840 1x PSD WB 7 WH	96380925	
	32 W (1.7 m)	L80 at 70,000 hrs		4000K	≥ 80	LL121X LED45S/840 PSU DA20 5 WH	88183400	
CoreLine wall-mounted luminaire* 	12 W	L70 at 50,000 hrs	1200 lm	3000K	≥ 80	WL130V LED12S/830 PSU WH	38778599	
	12 W	L70 at 50,000 hrs	1200 lm	4000K	≥ 80	WL130V LED12S/840 PSU WH	38779299	
	22 W	L70 at 50,000 hrs	2000 lm	3000K	≥ 80	WL130V LED20S/830 PSU WH	38780899	
	22 W	L70 at 50,000 hrs	2000 lm	4000K	≥ 80	WL130V LED20S/840 PSU WH	38781599	
	22 W	L70 at 50,000 hrs	2000 lm	3000K	≥ 80	WL130V LED20S/830 PSU MDU WH	38782299	
	22 W	L70 at 50,000 hrs	2000 lm	4000K	≥ 80	WL130V LED20S/840 PSU MDU WH	38783999	
	36 W	L70 at 50,000 hrs	3400 lm	3000K	≥ 80	WL131V LED34S/830 PSU WH	38784699	
	36 W	L70 at 50,000 hrs	3400 lm	4000K	≥ 80	WL131V LED34S/840 PSU WH	38785399	
	15 W	L70 at 50,000 hrs	1200 lm	3000K	≥ 80	WL131V LED12S/830 PSR MDU WH	38786099	
	15 W	L70 at 50,000 hrs	1200 lm	4000K	≥ 80	WL131V LED12S/840 PSR MDU WH	38787799	
	26 W	L70 at 50,000 hrs	2000 lm	3000K	≥ 80	WL131V LED20S/830 PSR MDU WH	38788499	
	26 W	L70 at 50,000 hrs	2000 lm	4000K	≥ 80	WL131V LED20S/840 PSR MDU WH	38789199	
	39 W	L70 at 50,000 hrs	3400 lm	3000K	≥ 80	WL131V LED34S/830 PSR MDU WH	38790799	
39 W	L70 at 50,000 hrs	3400 lm	4000K	≥ 80	WL131V LED34S/840 PSR MDU WH	38791499		
CoreLine waterproof* 	17.6 W	L75 at 50,000 hrs	2100 lm	4000K	≥ 80	WT120C LED18S/840 PSU L600	84045900	
	23.5 W	L75 at 50,000 hrs	2900 lm	4000K	≥ 80	WT120C LED22S/840 PSU L1200	84046600	
	29.5 W	L75 at 50,000 hrs	3500 lm	4000K	≥ 80	WT120C LED34S/840 PSU L1500	84047300	
	35.5 W	L75 at 50,000 hrs	4100 lm	4000K	≥ 80	WT120C LED40S/840 PSU L1200	84048000	
	48 W	L75 at 50,000 hrs	6000 lm	4000K	≥ 80	WT120C LED60S/840 PSU L1500	84049700	
	18.5 W	L75 at 50,000 hrs	2100 lm	4000K	≥ 80	WT120C LED18S/840 PSD L600	88306800	
	24.5 W	L75 at 50,000 hrs	2900 lm	4000K	≥ 80	WT120C LED22S/840 PSD L1200	88307500	
	30 W	L75 at 50,000 hrs	3500 lm	4000K	≥ 80	WT120C LED34S/840 PSD L1500	88308200	
	36.5 W	L75 at 50,000 hrs	4100 lm	4000K	≥ 80	WT120C LED40S/840 PSD L1200	88309900	
	49.5 W	L75 at 50,000 hrs	6000 lm	4000K	≥ 80	WT120C LED60S/840 PSD L1500	88310500	
	32 W	L75 at 50,000 hrs	4100 lm	4000K	≥ 80	WT120C LED40S/840 PSU WEC L1200	16316700	
	32 W	L75 at 50,000 hrs	4100 lm	4000K	≥ 80	WT120C LED40S/840 PSU TW1 WEC L1200	16317400	
	48 W	L75 at 50,000 hrs	6000 lm	4000K	≥ 80	WT120C LED60S/840 PSU WEC L1500	16318100	
	48 W	L75 at 50,000 hrs	6000 lm	4000K	≥ 80	WT120C LED60S/840 PSU TW1 WEC L1500	16319800	
	70 W	L75 at 50,000 hrs	8000 lm	4000K	≥ 80	WT120C LED80S/840 PSU L1500	40928900	
	67 W	L75 at 50,000 hrs	8000 lm	4000K	≥ 80	WT120C LED80S/840 PSD L1500	40929600	







Overview CoreLine outdoor products

CoreLine	Wattage	Lifetime	Luminous Flux	Color Temp.	CRI	Product description	EOC code
CoreLine bollard 	13 W	L70 at 50,000 hrs	1000 lm	3000K	≥ 80	BCP155 LED100/WW PSU 220-240V A 7043	38375600
	13 W	L70 at 50,000 hrs	1000 lm	3000K	≥ 80	BCP155 LED100/WW PSU 220-240V S 7043	38377000
	12 W	L70 at 50,000 hrs	1000 lm	4000K	≥ 80	BCP155 LED100/NW PSU 220-240V A 7043	38376300
	12 W	L70 at 50,000 hrs	1000 lm	4000K	≥ 80	BCP155 LED100/NW PSU 220-240V S 7043	38378700
	n/a	n/a	n/a	n/a	n/a	n/a	ZCP150 ANB 500
CoreLine malaga small 	29,5 W	L70 at 100,000 hrs	3700 lm	4000K	≥ 70	BRP101 LED37/740 DM 42-60A	99815100
	29,5 W	L70 at 100,000 hrs	3700 lm	4000K	≥ 70	BRP101 LED37/740 II DM 42-60A*	99816800
CoreLine malaga medium 	39 W	L70 at 100,000 hrs	5500 lm	4000K	≥ 70	BRP102 LED55/740 DM 42-60A	99817500
	39 W	L70 at 100,000 hrs	5500 lm	4000K	≥ 70	BRP102 LED55/740 II DM 42-60A*	99818200
	56,5 W	L70 at 100,000 hrs	7500 lm	4000K	≥ 70	BRP102 LED75/740 DM 42-60A	99819900
	56,5 W	L70 at 100,000 hrs	7500 lm	4000K	≥ 70	BRP102 LED75/740 II DM 42-60A*	99820500
	81 W	L70 at 100,000 hrs	11,000 lm	4000K	≥ 70	BRP102 LED110/740 DM 42-60A	99821200
	81 W	L70 at 100,000 hrs	11,000 lm	4000K	≥ 70	BRP102 LED110/740 II DM 42-60A*	99822900
CoreLine tempo large up to 217 W 	217 W	L80 at 75,000 hrs	26,000 lm	4000K	> 70	BVP130 LED260/740 A	09639700
	162 W	L80 at 75,000 hrs	21,000 lm	4000K	> 70	BVP130 LED210/740 A	09640300
	120 W	L80 at 75,000 hrs	16,000 lm	4000K	> 70	BVP130 LED160/740 A	09641000
	217 W	L80 at 75,000 hrs	26,000 lm	4000K	> 70	BVP130 LED260/740 S	09642700
	162 W	L80 at 75,000 hrs	21,000 lm	4000K	> 70	BVP130 LED210/740 S	09643400
	120 W	L80 at 75,000 hrs	16,000 lm	4000K	> 70	BVP130 LED160/740 S	09644100
CoreLine tempo medium up to 93 W 	93 W	L80 at 75,000 hrs	12,000 lm	4000K	> 70	BVP125 LED120/740 A	09723300
	93 W	L80 at 75,000 hrs	12,000 lm	4000K	> 70	BVP125 LED120/740 S	09725700
	60 W	L80 at 75,000 hrs	8000 lm	4000K	> 70	BVP125 LED80/740 A	09724000
	60 W	L80 at 75,000 hrs	8000 lm	4000K	> 70	BVP125 LED80/740 S	09726400
CoreLine tempo small 	38 W	L80 at 75,000 hrs	4200 lm	4000K	≥ 80	BVP110 LED42/NW A	30635300
	38 W	L80 at 75,000 hrs	4200 lm	4000K	≥ 80	BVP110 LED42/NW S	30636000

* DALI and Emergency versions available















Overview Interact Ready CoreLine products



CoreLine	Wattage	Lifetime	Luminous Flux	Color Temp.	CRI	Product description	EOC code
CoreLine downlight* 	22 W	L70 to 50,000 hrs	2200 lm	3000K	≥ 80	DN140B LED20S/830 WR IA1	32612200
	22 W	L70 to 50,000 hrs	2200 lm	4000K	≥ 80	DN140B LED20S/840 WR IA1	32613900
	22 W	L70 to 50,000 hrs	2200 lm	3000K	≥ 80	DN140B LED20S/830 C IA1	32614600
	22 W	L70 to 50,000 hrs	2200 lm	4000K	≥ 80	DN140B LED20S/840 C IA1	32615300
CoreLine panel* 	34 W	L75 to 50,000 hrs	3600 lm	4000K	≥ 80	RC132V LED36S/840 W60L60 IA1 NOC	38516300
	34 W	L75 to 50,000 hrs	3400 lm	3000K	≥ 80	RC132V LED34S/830 W60L60 IA1 NOC	38517000
	34 W	L75 to 50,000 hrs	3600 lm	4000K	≥ 80	RC133V LED36S/840 W62L62 IA1 NOC	38518700
	34 W	L75 to 50,000 hrs	3600 lm	4000K	≥ 80	RC132V LED36S/840 W30L120 IA1 NOC	38519400
	34 W	L75 to 50,000 hrs	3600 lm	4000K	≥ 80	RC132V LED36S/840 W60L60 IA1 OC	38520000
	34 W	L75 to 50,000 hrs	3400 lm	3000K	≥ 80	RC132V LED34S/830 W60L60 IA1 OC	38521700
	34 W	L75 to 50,000 hrs	3600 lm	4000K	≥ 80	RC133V LED36S/840 W62L62 IA1 OC	38522400
	34 W	L75 to 50,000 hrs	3600 lm	4000K	≥ 80	RC132V LED36S/840 W30L120 IA1 OC	38523100
CoreLine recessed luminaire* 	35.5 W	L75 to 50,000 hrs	3700 lm	4000K	≥ 80	RC134B LED37S/840 W60L60 IA1 OC	99648500
	35.5 W	L75 to 50,000 hrs	3700 lm	4000K	≥ 80	RC134B LED37S/840 W60L60 IA1 NOC	99649200
	35.5 W	L75 to 50,000 hrs	3700 lm	3000K	≥ 80	RC134B LED37S/830 W60L60 IA1 NOC	99650800
	35.5 W	L75 to 50,000 hrs	3700 lm	3000K	≥ 80	RC134B LED37S/830 W60L60 IA1 OC	99651500
	35.5 W	L75 to 50,000 hrs	3700 lm	4000K	≥ 80	RC135B LED37S/840 W62L62 IA1 OC	99652200
	35.5 W	L75 to 50,000 hrs	3700 lm	4000K	≥ 80	RC134B LED37S/840 W30L120 IA1 NOC	99653900
	35.5 W	L75 to 50,000 hrs	3700 lm	4000K	≥ 80	RC134B LED37S/840 W30L120 IA1 OC	99654600
	35.5 W	L75 to 50,000 hrs	3700 lm	4000K	≥ 80	RC135B LED37S/840 W62L62 IA1 NOC	99655300
	35.5 W	L75 to 50,000 hrs	3700 lm	3000K	≥ 80	RC134B LED37S/830 W30L120 IA1 OC	99656000
	35.5 W	L75 to 50,000 hrs	3700 lm	3000K	≥ 80	RC134B LED37S/830 W30L120 IA1 NOC	99657700
	31.5 W	L75 to 50,000 hrs	3700 lm	3000K	≥ 80	RC134B LED37S/830 PSD W60L60 OC	34813700
	31.5 W	L75 to 50,000 hrs	3700 lm	3000K	≥ 80	RC134B LED37S/830 PSD W30L120 OC	34815100
CoreLine slim downlight 	27 W	L70 to 50,000 hrs	2000 lm	3000K	≥ 80	DN135B LED20S/830 IA1 WH	38922299
	27 W	L70 to 50,000 hrs	2000 lm	4000K	≥ 80	DN135B LED20S/840 IA1 WH	38924699
CoreLine surface-mounted luminaire* 	35.5 W	L75 to 50,000 hrs	3700 lm	4000K	≥ 80	SM134V LED37S/840 W20L120 IA1 NOC	99662100
	35.5 W	L75 to 50,000 hrs	3700 lm	4000K	≥ 80	SM134V LED37S/840 W20L120 IA1 OC	99663800
	35.5 W	L75 to 50,000 hrs	3700 lm	4000K	≥ 80	SM134V LED37S/830 W20L120 IA1 NOC	99664500
	35.5 W	L75 to 50,000 hrs	3700 lm	4000K	≥ 80	SM134V LED37S/840 W60L60 IA1 NOC	99665200
	35.5 W	L75 to 50,000 hrs	3700 lm	4000K	≥ 80	SM134V LED37S/830 W20L120 IA1 OC	99666900
	35.5 W	L75 to 50,000 hrs	3700 lm	4000K	≥ 80	SM134V LED37S/840 W60L60 IA1 OC	99667600
	35.5 W	L75 to 50,000 hrs	3700 lm	4000K	≥ 80	SM134V LED37S/830 W60L60 IA1 NOC	99668300
	35.5 W	L75 to 50,000 hrs	3700 lm	4000K	≥ 80	SM134V LED37S/830 W60L60 IA1 OC	99669000
CoreLine waterproof* 	36.5 W	L75 to 50,000 hrs	4100 lm	4000K	≥ 80	WT120C LED40S/840 IA1 L1200	39713500
	49.5 W	L75 to 50,000 hrs	6000 lm	4000K	≥ 80	WT120C LED60S/840 IA1 L1500	39714200

* Emergency options available

Overview CoreLine accessories

Related product		Accessory name	Product description	EOC code
CoreLine recessed luminaire (p 16) 		Frame for plaster ceiling installation	RC134Z CFRM-PLC W60L60 WH	22557700
			RC134Z CFRM-PLC W62L62 WH	98723000
		Frame for plaster ceiling installation (rectangular)	RC134Z CFRM-PLC W30L120 WH	98724700
CoreLine panel (p 14) 		Safety cable (G3 only)	RC132Z SC	8653599
		Suspension set (G3 PSU)	RC132Z SME-3 WH	8655999
		Suspension set (G3 PSD)	RC132Z SME-4 WH	8657399
		Plaster ceiling springs (G2/G3)	RC125Z SMB-PLC	7333999
		Surface mounting accessory (G2/G3)	RC125Z SMB W60L60	7330899
			RC125Z SMB W62L62	7331599
		Surface mounting accessory (G2/G3), rectangular	RC125Z SMB W30L120	7332299
RC132Z SMB W30L60			8659799	
CoreLine surface-mounted luminaire (p 19) 		Suspension set without electrical connection	SM134Z SMS	34896000
		Suspension set for PSU	SM134Z SME-3	34897700
		Suspension set for DALI	SM134Z SME-5	34895300

CoreLine. Just the beginning

Lighting pros know how important it is to have the right tools. Which is why when you choose CoreLine you get much more than a high-quality range of LED luminaires and sensors that work together seamlessly – you get full back up and support from Philips.

On our website you'll find a wide range of free lighting tools that help you make the most out of CoreLine products. From detailed case studies to helpful installation videos our services help you work smarter and better.

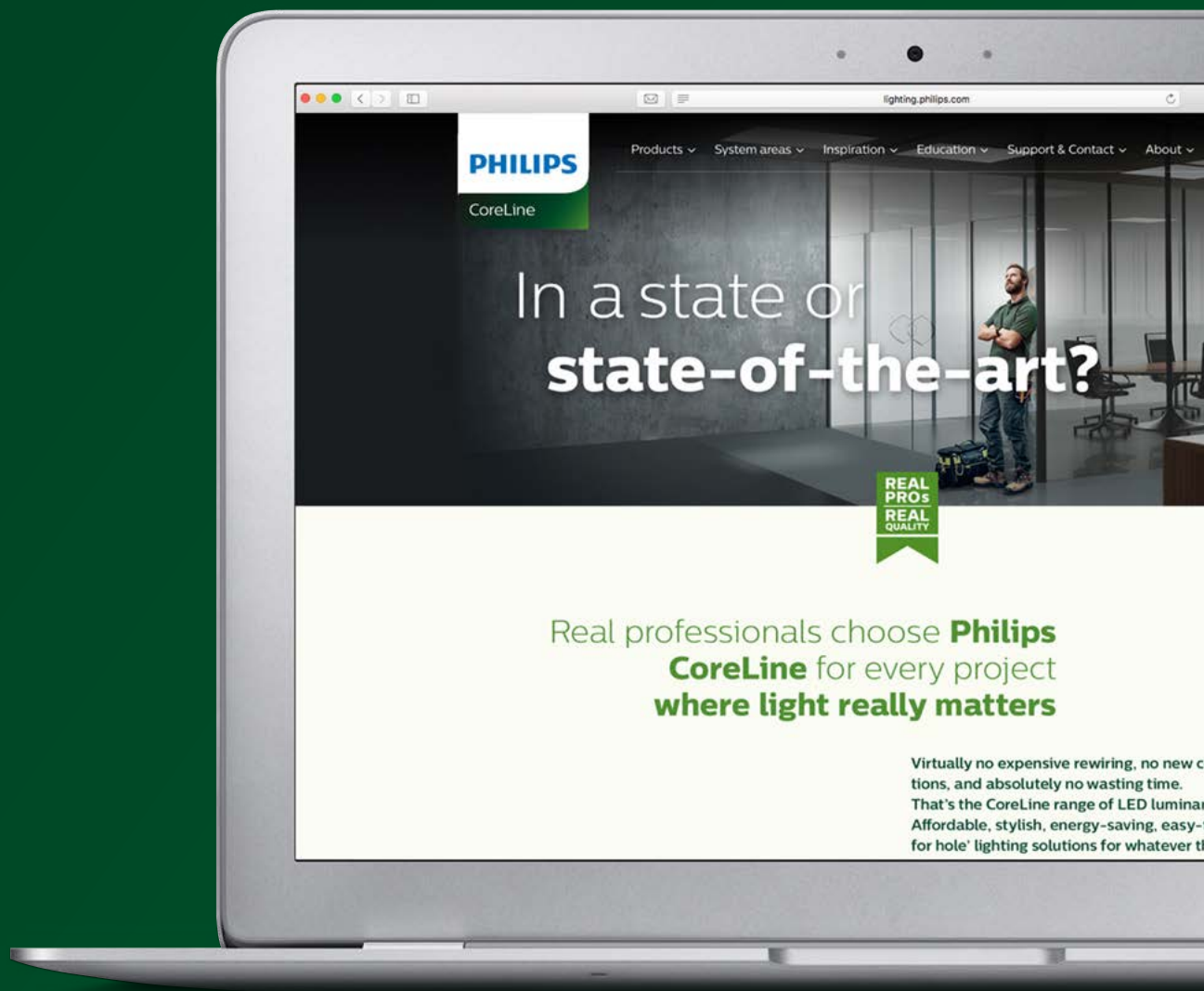

philips.com/coreline



Case studies

What better way to discover new lighting solutions than to see how the products have been used before? Read up on our case studies and pick up some extra inspiration!



Showcase

Go on an interactive virtual 360° building tour to see CoreLine in action. Take the full tour to see every space, or choose the product or application you want to see.

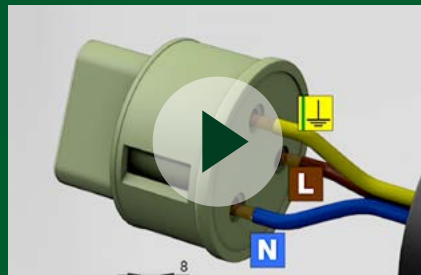

Installation movies

Deploying CoreLine products is a breeze with our specially developed installation videos. Get your step-by-step guide for every product in the range.



For more information, take the quick route to our website by scanning this QR code.

