

PHILIPS

Horticulture LED Solutions

GreenPower LED toplighting

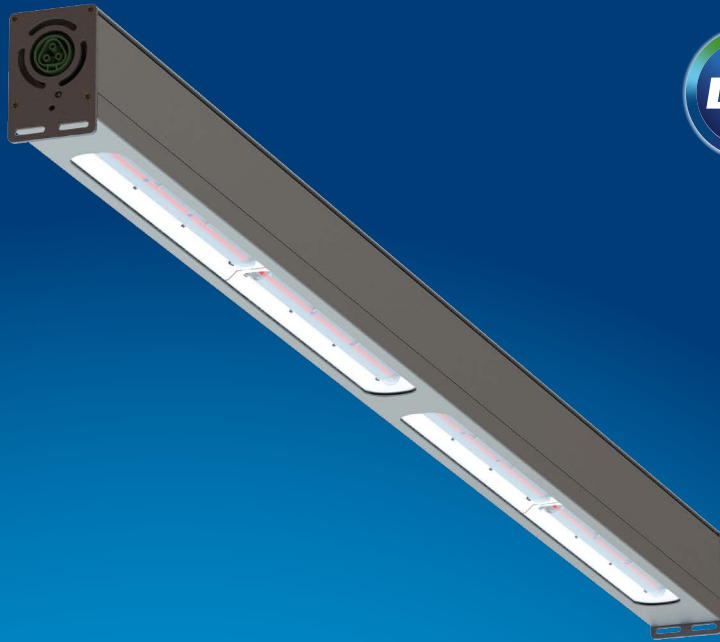

Quick installation guide

USA/Canada

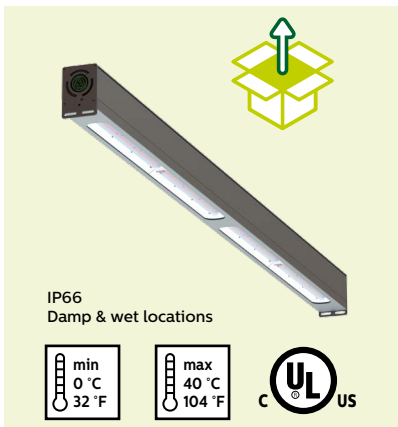

WARNING

Turn off and disconnect power before installation. Must be installed by a qualified electrician in accordance with all national and local electrical and construction codes and regulations.

IMPORTANT!

Verify and follow local electric codes for the installation site:

- Make sure that power cords are routed in a manner that would prevent incidental damage
- Make use of junction boxes that are suitable for the power cords used in the application
- Make use of strain-relief or power cord grip in case needed

Dimensions in mm/inch

Product	Dimensions (mm/inch)		
	Length	Width	Height
GreenPower LED toplighting module	1264.2 / 49.77	55.2 / 2.17	80.2 / 3.16

Note: build length is 1250 mm (49.213 inch).

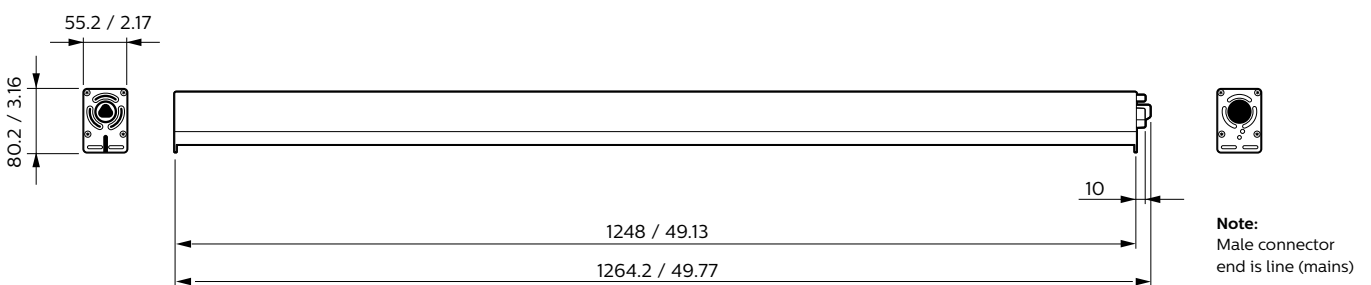

January 2016

Continuous line installation



This is an installation in which modules are connected to one another in a continuous line.

What do you need?



LED toplighting module

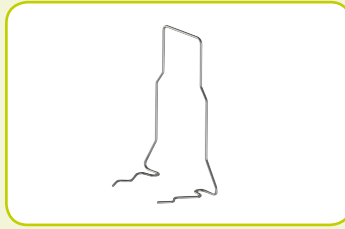

Mounting bracket



End cap



Main power cable



WARNING

- DO NOT connect to live power until installation is complete
- DO NOT attempt to install or use until you read and understand the installation instruction and safety labels
- DO NOT modify or alter the product; doing so will void the warranty

What steps to take:

1

Mount 40 x 40 mm ± 1.5 mm (1.57 x 1.57 inch ± 0.06 inch) C-profile framing system onto your greenhouse structure at the desired height. Do not place any hooks on the exterior of the framing system that exceeds the 12 mm (0.472 inch) clearance.

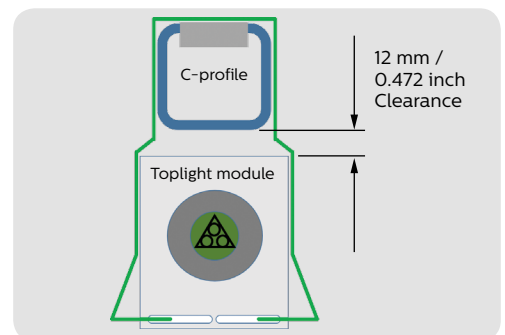

2

Attach two mounting brackets onto the framing system at a pitch distance of 1250 mm (49.21 inch). Be sure mounting brackets face **same direction with prongs pointing away** from the power source.

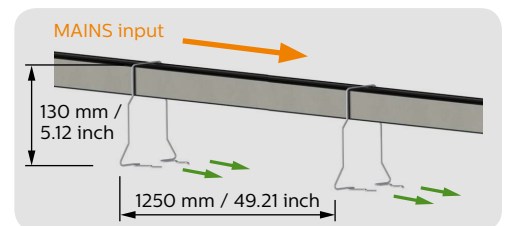

3

With the male end of LED module directed towards power source, position the LED module parallel and close to framing system. Slide the module towards the mounting bracket so that the bracket prongs pass through the module's mounting holes and until the module snaps into the bracket's back locking point.

- Ⓐ Back locking point
- Ⓑ Pre-positioning point

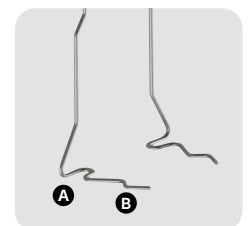
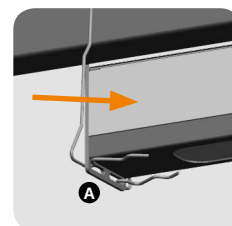

4

On the opposite end of the module, take the second mounting bracket and slide it towards the end of the module so that the prongs pass through the module's mounting holes. Snap the bracket into the bracket's pre-positioning point.

- A Female or end of module
- B Pre-positioning point

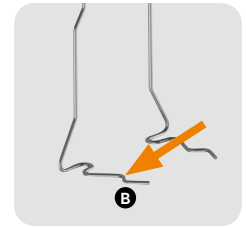
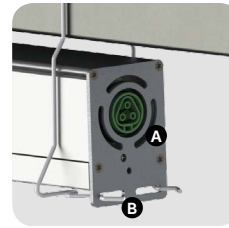

5

Take a second toplighting module and position it with the front end (male connector) towards the back end (female connector) of the first module.

- A Female
- B Male

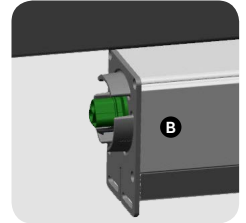
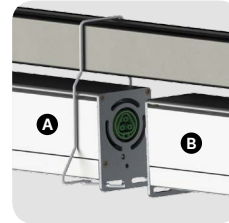

6

Plug the two modules together. Be sure the mounting bracket is secure by snapping both modules into the back locking point of the bracket. **This will securely support the modules and ensure that the modules remain stable.**

- A Module 1
- B Module 2
- C Back locking point

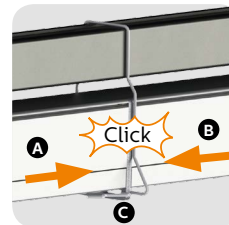

7

Repeat steps 2-6 until the maximum number of modules is reached. See page 6 for maximum number of modules for power grid and system configuration.

8

For the last module in the line, insert an end cap into the female connector until the end cap clicks into place. This must be done to ensure safe system operation and also protect the module from moisture and debris. Proper installation of the end cap ensures the module is IP66 and "damp & wet location" rated.



9

Return to the first module in the line and securely plug the female connector with cable and then connect the cable to the mains power source.

- A Female
- B Male

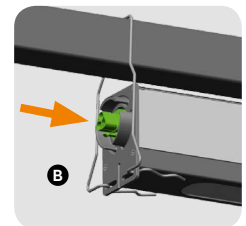

WARNING

* Refer to the table on page 6 to determine the maximum number of modules that can be interconnected.

DO NOT use more than a 15 amp C type circuit breaker in combination with the type of power grid available (208 V - 240 V - 277 V - 347 V).

DO NOT connect to live power until installation is complete.

Non-continuous line installation



This is an installation in which modules are placed at distances specified by the light plan and modules are connected with jumper cables.

What do you need?



LED toplighting module

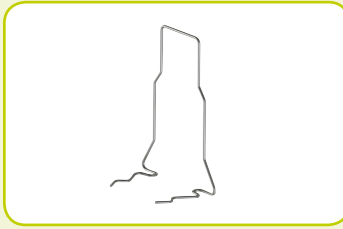

Mounting bracket



Jumper cable*



End cap



Main power cable



WARNING

- DO NOT connect to live power until installation is complete
- DO NOT attempt to install or use until you read and understand the installation instruction and safety labels
- DO NOT modify or alter the product; doing so will void the warranty

*Jumper cable

In case of distances greater than 2000 mm (6.6 ft) use two jumper cables.

What steps to take:

1

Mount 40 x 40 mm ± 1.5 mm (1.57 x 1.57 inch ± 0.06 inch) C-profile framing system onto your greenhouse structure at the desired height. Do not place any hooks on the exterior of the framing system that exceeds the 12 mm (0.472 inch) clearance.

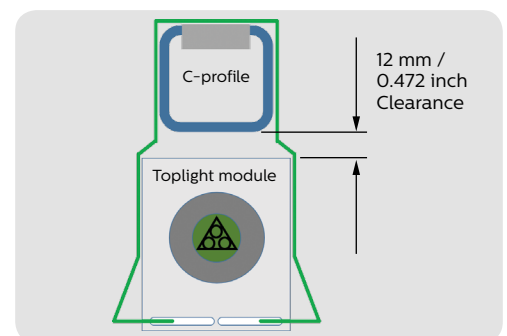

2

Attach two mounting brackets onto the framing system at a pitch distance of 1250 mm (49.21 inch). Be sure mounting brackets are positioned with **prongs pointing inward and towards each other**.

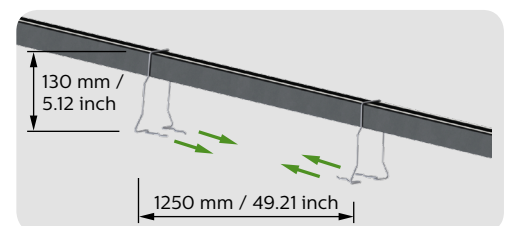

3 Position the LED module parallel and close to framing system. Slide the module towards the mounting bracket so that the bracket prongs pass through the module's mounting holes and until the module snaps into the bracket's back locking point.

B Back locking point

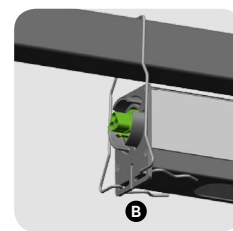

4 On the opposite end of the module, slide the second mounting bracket towards the end of the module so that the prongs pass through the module's mounting holes. Snap the bracket into the bracket's back locking point.

B Back locking point

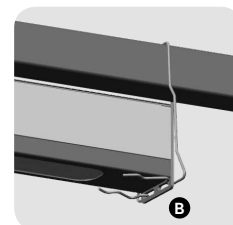

5 Continue to attach modules to the C-profile framing system by repeating steps 2-4 until maximum number of modules is reached. See page 6 for maximum number of modules for power grid and system configuration.

6 Connect the modules with jumper cables.

A) For installations with modules placed at distances less than 2000 mm (6.6 ft), use a Philips jumper cable to connect each module.

B) If the modules are at distances greater than 2000 mm (6.6 ft) connect two jumper cables together.



7 Continue connecting the modules with jumper cables.

A Female
B Male

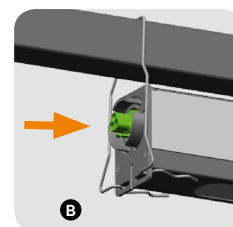
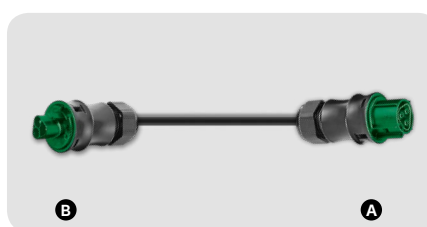
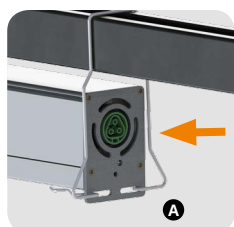

8 For the last module in the line, insert an end cap into the female connector until the end cap clicks into place. This must be done to ensure safe system operation and also protect the module from moisture and debris. It also secures the IP66 or "damp & wet locations" rating.



9 Return to the first module in the line and securely plug the female connector with cable and then connect the cable to the mains power source.

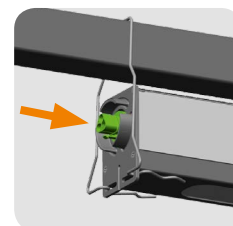



WARNING

To determine the maximum number of modules that can be interconnected refer to the table below.
 Do not use more than a 15 amp C type circuit breaker in combination with the type of power grid available (208 V - 240 V - 277 V - 347 V).
 DO NOT connect to live power until installation is complete.

Maximum number of LED modules connected to power grid related to system configuration

Mains Voltage [Vac]	System configuration	Circuit Breaker C-type [Amp]	Circuit Breaker configuration type	Max # of modules per phase pair
208	P-P	15	3P	7
208	P-P	15	3X2P	12
240	P-P	15	3P	8
240	P-P	15	3X2P	14
277	P-N	15	4P	17
347	P-N	15	4P	21

N = Neutral

P = Phase

3P = 3 phase breaker type

2P = 2 Phase breaker type

4P = 3Phase + Neutral breaker type

For detailed system configurations see Application Guide

Specifications Philips GreenPower LED toplighting

Philips GreenPower LED toplighting	Voltage	Photon flux	Power consumption	Useful lifetime*		Power factor	Ingress protection rating**
	V	µmol/s	W	hours / L90	hours / L70	cos φ	
Deep Red/Blue types							
Deep Red/Blue - Low Blue	200-400	550	215	25,000	50,000	> 0.95 @ 400 V	IP66
Deep Red/Blue - Low Blue - Wide beam	200-400	520	215	25,000	50,000	> 0.95 @ 400 V	IP66
Deep Red/Blue - Medium Blue	200-400	550	215	25,000	50,000	> 0.95 @ 400 V	IP66
Deep Red/Blue - High Blue	200-400	520	200	25,000	50,000	> 0.95 @ 400 V	IP66
Deep Red/White types							
Deep Red/White - Low Blue	200-400	520	200	25,000	50,000	> 0.95 @ 400 V	IP66
Deep Red/White - Medium Blue	200-400	520	200	25,000	50,000	> 0.95 @ 400 V	IP66
Deep Red/White - Medium Blue VISN	200-400	430	190	25,000	50,000	> 0.95 @ 400 V	IP66
Deep Red/White/Far Red type							
Deep Red/White/Far Red - Medium Blue	200-400	410	175	25,000	50,000	> 0.95 @ 400 V	IP66

* Lifetime and maintenance values are given at an ambient temperature of 25 °C / 77 °F.

** Suitable for dry and damp locations.

Ordering data Philips GreenPower LED toplighting

Philips GreenPower LED toplighting	Product ID	Order code	
		6NC	12NC
Deep Red/Blue types			
Deep Red/Blue - Low Blue ¹	GPL toplighting DR/B LB 200-400V	303818	9290 009 79906
Deep Red/Blue - Low Blue - Wide beam ¹	GPL toplighting DR/B LB 200-400V WB	303834	9290 009 80006
Deep Red/Blue - Medium Blue ¹	GPL toplighting DR/B MB 200-400V	303842	9290 009 80106
Deep Red/Blue - High Blue ¹	GPL toplighting DR/B HB 200-400V	303859	9290 009 80206
Deep Red/White types			
Deep Red/White - Low Blue	GPL toplighting DR/W LB 200-400V	303867	9290 009 80306
Deep Red/White - Medium Blue	GPL toplighting DR/W MB 200-400V	303883	9290 009 80406
Deep Red/White - Medium Blue VISN	GPL toplighting DR/W MB_VISN 200-400V	303891	9290 009 80506
Deep Red/White/Far Red type			
Deep Red/White/Far Red - Medium Blue	GPL toplighting DR/W/FR_2 MB 200-400V	303909	9290 009 80606

¹ Eye safety risk group 2

IEC62471 : Photobiological safety of lamps and lampsystems. LED does not pose a hazard due to the aversion response or thermal discomfort.

Accessories Philips GreenPower LED toplighting

Philips GreenPower LED toplighting	Remarks	Order code	
		6NC	12NC
GPL bracket toplighting NAM	Stainless steel wire of 2 mm (0.08 inch) in diameter	303925	9290 015 08106
GPL toplighting jumper NAM 6.6ft	3 x 2.0 mm ² (AWG14) wire conductors	303933	9290 015 08206
GPL toplighting main power cable	3 x 2.0 mm ² (AWG14) wire conductors 2 meter (6.6 ft)	304188	9290 015 16206
GPL toplighting end cap		303966	9290 009 15606



© Philips Lighting Holding B.V. 2016. All rights reserved. Philips reserves the right to make changes in specifications and/or to discontinue any product at any time without notice or obligation and will not be liable for any consequences resulting from the use of this publication.

Document order number: 3222 635 70068 - UL/CSA - V1
01/2016
Data subject to change

For more information about
Philips Horticulture LED Solutions visit:
www.philips.com/horti

Write us an e-mail:
horti.info@philips.com

Or tweet us:
[@PhilipsHorti](https://twitter.com/PhilipsHorti)