



PHILIPS

PrimeSet
RDL500



Technical leaflet

Freezer cabinets

Lighting food. Brightening faces.

Philips LED lighting for refrigeration cases has a proven track record as a sustainable and energy-efficient way to create an enjoyable shopping experience for customers – while at the same time supporting retailers' brand values. Thanks to their new, slim design,

the PrimeSet RDL500 modules can be aesthetically integrated in the door frames of vertical door freezers.

The modules' unique integrated optical system directs the light in such a way that the products on display are presented uniformly, while reducing glare and dark spots.

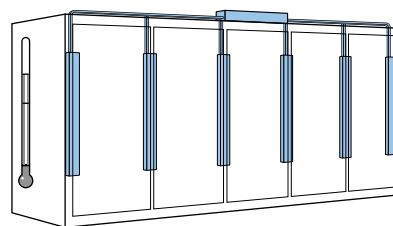

www.philips.com/retaildisplaylighting





Design highlights

- Improved visibility and presentation of the frozen food on display; uniform light distribution throughout the entire cabinet.
- Reduced complexity as each module can be center or side lit.
- Aesthetic integration of the modules into door frames, enabling better visibility of the products on display and increased storage space.
- Virtually maintenance-free throughout the lifetime of the cabinets, since the LEDs have a long lifetime of 50,000 hours with excellent lumen maintenance.
- Ideal for integration in mullions of vertical refrigeration cabinets.



“ Ideal for **vertical integration** in millions of vertical refrigeration cabinets.”



Environment

Significantly improved sustainability due to lower energy consumption, reduced waste and elimination of hazardous substances such as mercury and lead. These modules are RoHS compliant.

Product features

- Ultra slim design with integrated optics.
- Waterproof (IP rating: 65).
- CRI greater than 85 for high color rendering
- Light Level of 850 Lux significantly reduces energy consumption while providing excellent illumination of the product.
- Each module can be center or side lit by applying a center or side cable.
- Together with the center mounting profile the light distribution will be in two directions. With the side mounting profile the light distribution will be in one direction.
- DLC listed as vertical and horizontal refrigeration display case luminaire.
- 5-year Philips warranty for the modules in combination with the Philips LED power driver.

PrimeSet RDL500 module

Specifications

- The rated average life of the module, in combination with a Philips LED power driver, is B50L70 at 50,000 hours (70% lumen maintenance). This rated average life is based on three switching cycles per day.
- Operating temperature (performances) min -30 °C / max +30 °C.
- Storage temperature min -30 °C / max +60 °C.
- Housing color: black.
- LM-79 , LM-80 tests and reports are performed in accordance to IESNA standards. Projected L70 >_ 50000 hours per IES TM-21
- Safety Extra Low Voltage (SELV).
- Compliance and approval; ENEC, UL, CE, Product safety class III, RoHS, WEEE, EU directive 2002/95/EC, NSF, CSA, REACH.
- The color consistency of the modules is 5 SDCM.
- Instant start-up with full illumination.
- The rated peak intensity is and 215 cd for RDL500.
- The Rated beam angle is 30°.
- The Power Factor with Philips LED Power driver is > 0.9.
- Modules when paired with advance drivers per Driver chart are DLC listed.

Light distribution

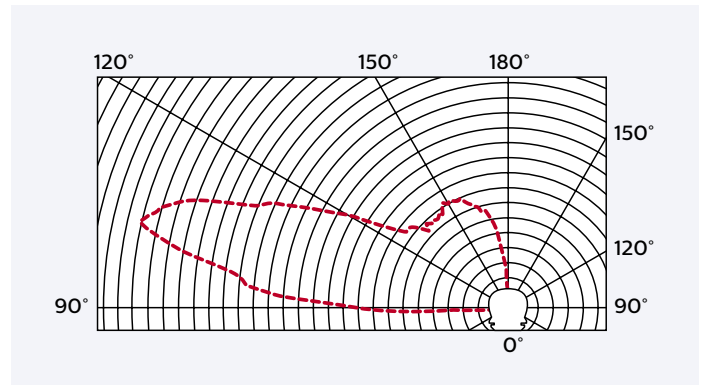

asymmetrical 30° (side)

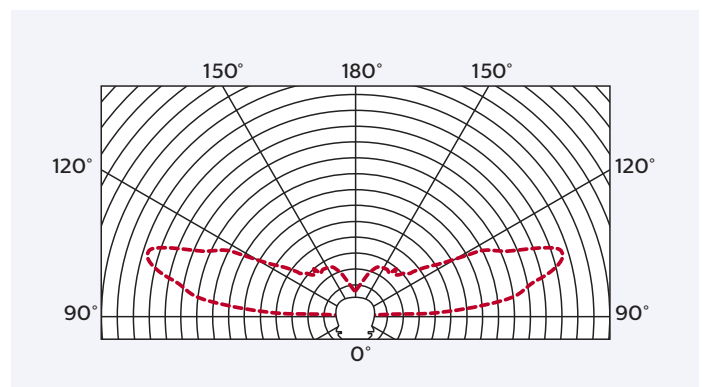

symmetrical 30° both directions (center)

Spectral power distribution

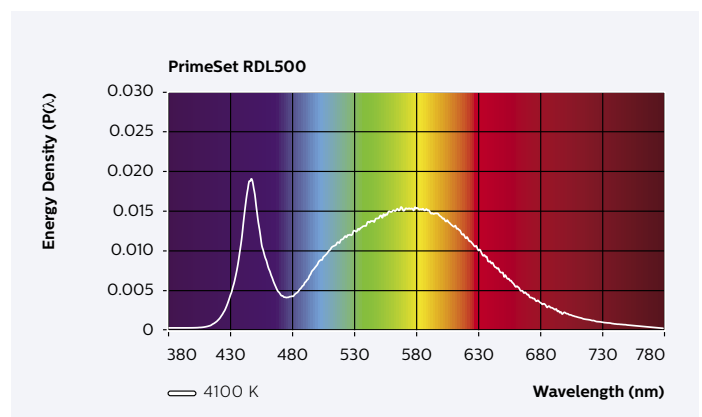
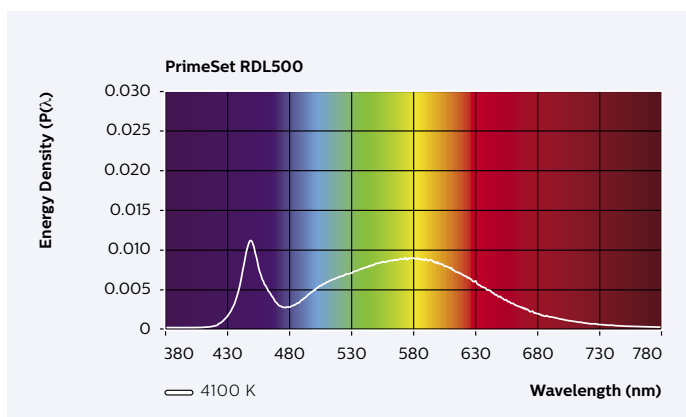

Chromaticity coordinates

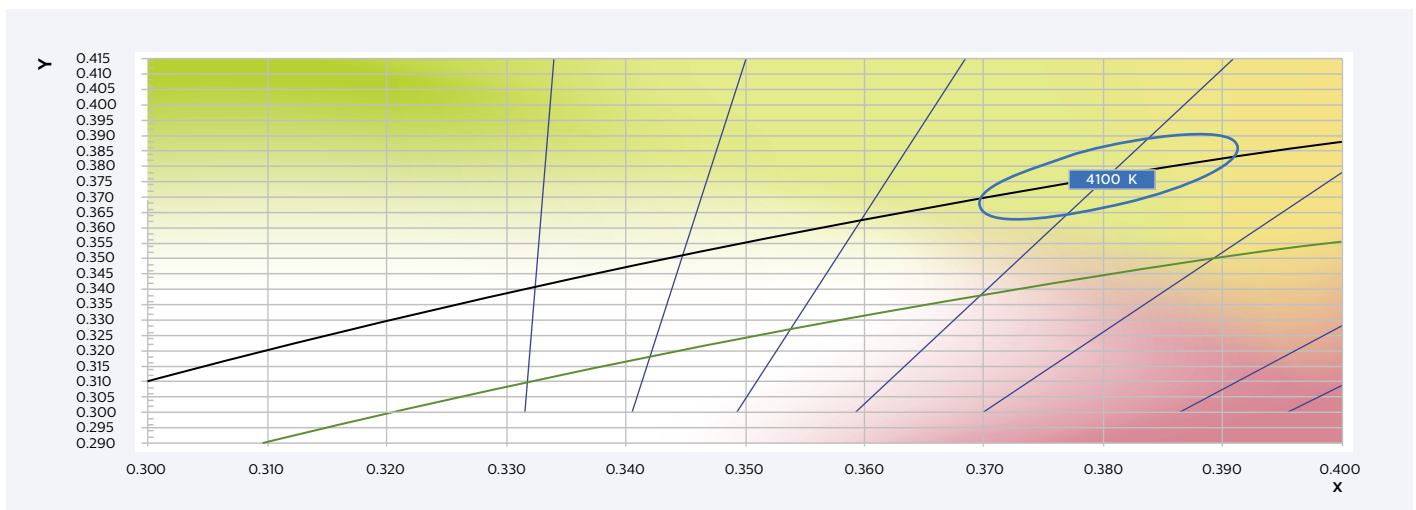

Lumen Maintenance

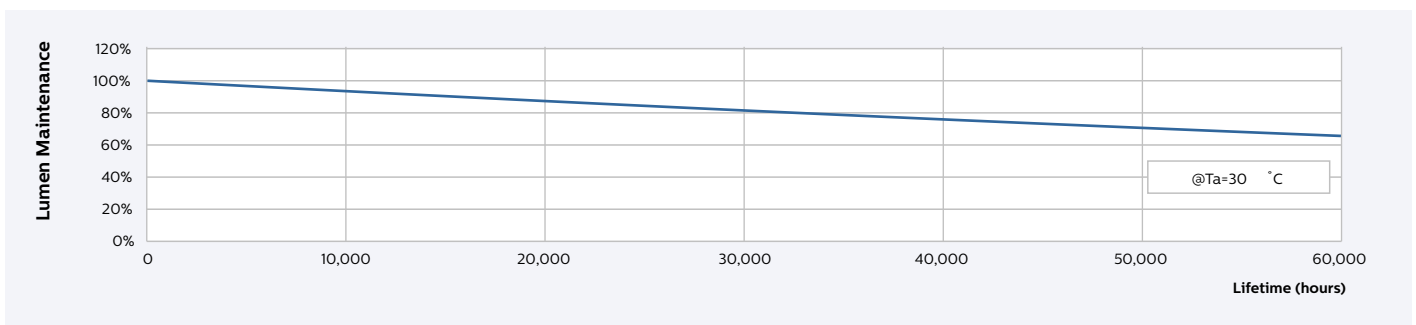

Technical Specifications

Product type	Light color	Rated power W	Rated luminous flux (lumen) lm	Color Rendering Index CRI	Correlated Color Temperature K
PrimeSet RDL500 - 850 lux					
PrimeSet RDL500 1200mm (47") 840 G1+	Neutral White	7.2	900	85	4000
PrimeSet RDL500 1500mm (59") 840 G1+	Neutral White	9.5	1200	85	4000
PrimeSet RDL500 1700mm (67") 840 G1	Neutral White	10.3	1300	85	4000

Note: - The rated power is based on DC input
 - @ -20 °C
 - r9 > 20

PrimeSet RDL500

Example of RDL modules with center and side mounting profiles placed in a five door freezer (top view).

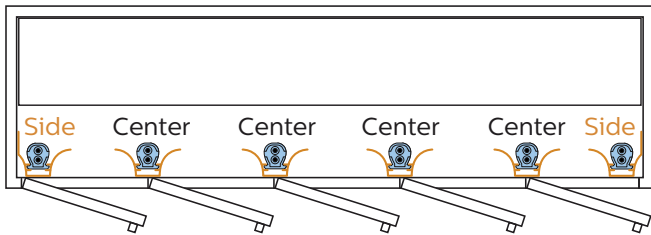

Dimensions PrimeSet RDL500

Type	A1	A3	B1	C1
PrimeSet RDL500 1200mm (47")	1198	1220	20.5	23
PrimeSet RDL500 1500mm (59")	1498	1520	20.5	23
PrimeSet RDL500 1700mm (67")	1698	1720	20.5	23

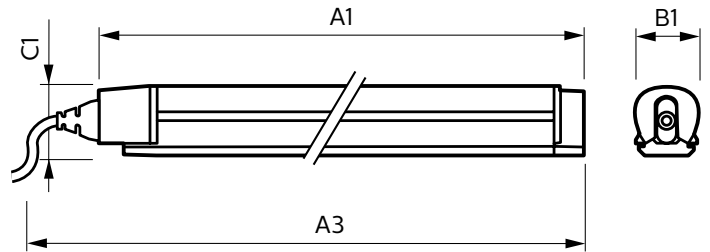

LED power driver

Power supply: Philips LED power driver

Philips PrimeSet LED display modules are only suitable for connection to a circuit from a class 2 power source with a limited energy supply. We have developed a LED power driver which is ideal for powering the PrimeSet modules.

To allow for variance in the installation, we recommend you do not load the power driver beyond 90% (77W and 100W driver) of its rated maximum power. Please refer to the wiring diagram in the installation guide for more details.



Dimensions LED power driver

Type	A	B	C
XITANIUM 77W 3.2A 24V INT-S	240	43.1	28.5
XITANIUM 100W 4.1A 24V FIX INT -S	240	43.1	28.5

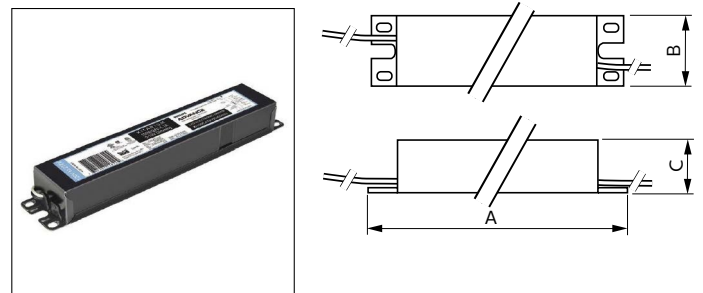

Xitanium Constant Voltage Outdoor driver 77W and 100W

Accessories

Mounting profiles with options for glare shielding

Our mounting profiles make it easy to install the modules. Thanks to the 'click-in' feature, the installation time is shortened considerably. The glare-free mounting profiles reduce glare to a minimum.

To ensure easy installation we supply mounting profiles that can be used to fix the modules in the mullions. They are available in two versions:

- Glare-free mounting profile for center module
- Glare-free mounting profile for side module

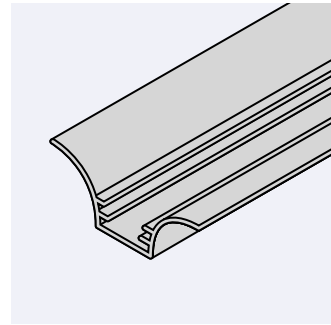

Glare-free mounting profile center

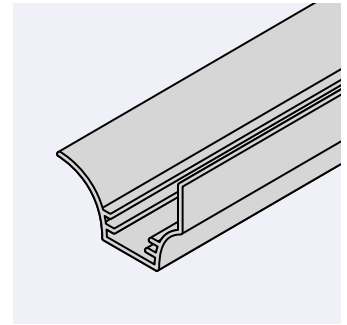

Glare-free mounting profile side

Dimensions mounting profile

Type	A	B1 Center	B1 Side	B2	C Center	C Side
PrimeSet RDL500 1200mm (47")	1167	56	46	23	23	40
PrimeSet RDL500 1500mm (59")	1468	56	46	23	23	40
PrimeSet RDL500 1700mm (67")	1668	56	46	23	23	40

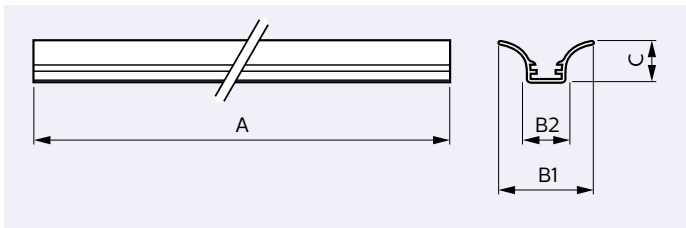

Glare-free mounting profile center

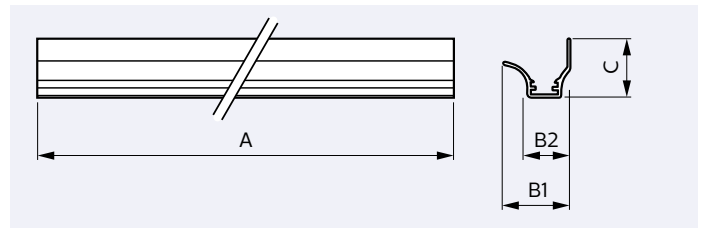

Glare-free mounting profile side

Parts needed per case

		6 Door	5 Door	4 Door	3 Door	2 Door
9290 021 78706	PrimeSet RDL 500 1200 mm (47") 840 G1+	7	6	5	4	3
9290 017 08113	XITANIUM 77W 3.2A 24V INT-S	1	1	1	1	1
9290 008 97706	PrimeSet RDL-mount prof CTR 1200mm-47" B*	5	4	3	2	1
9290 008 97806	PrimeSet RDL-mount prof SD 1200mm-47" B*	2	2	2	2	2
9290 009 57206	PrimeSet RDL - Centre Cable 2.5m (98") B	5	4	3	2	1
9290 009 57306	PrimeSet RDL - Side Cable 2.5m (98") B	2	2	2	2	2
929002178506	PrimeSet RDL 500 1500 mm (59") 840 G1+	7	6	5	4	3
929001708113	XITANIUM 77W 3.2A 24V INT-S	1	1	1	1	1
929000894506	Primeset RDL-mount prof CTR 1500mm-59" B*	5	4	3	2	1
929000895206	Primeset RDL-mount prof SD 1500mm-59" B*	2	2	2	2	2
929000957206	PrimeSet RDL - Centre Cable 2.5m (98") B	5	4	3	2	1
929000957306	PrimeSet RDL - Side Cable 2.5m (98") B	2	2	2	2	2
929002178306	PrimeSet RDL 500 1700 mm (67") 840 G1+	7	6	5	4	3
929001708113	XITANIUM 77W 3.2A 24V INT-S	1	1	1	1	1
929000894606	Primeset RDL-mount prof CTR 1700mm-67" B*	5	4	3	2	1
929000895306	Primeset RDL-mount prof SD 1700mm-67" B*	2	2	2	2	2
929000957206	PrimeSet RDL - Centre Cable 2.5m (98") B	5	4	3	2	1
929000957306	PrimeSet RDL - Side Cable 2.5m (98") B	2	2	2	2	2

Ordering information

PrimeSet LED modules

Type	Quantity per box	Ordering code
Standard - 850 lux		
PrimeSet RDL500 1200mm (47") 840 G1+	12	9290 021 78706
PrimeSet RDL500 1500mm (59") 840 G1+	12	9290 021 78506
PrimeSet RDL500 1700mm (67") 840 G1+	12	9290 021 78306

Accessories: Cables

Type	Quantity per box	Ordering code
Cable length - 2.5 meter		
PrimeSet RDL - Centre Cable 2.5m (98") B	24	9290 009 57206
PrimeSet RDL - Side Cable 2.5m (98") B	24	9290 009 57306

Xitanium Constant Voltage Outdoor LED Power Driver

Type	Quantity per box	Ordering code
XITANIUM 77W 3.2A 24V INT-S	20	9290 017 08113
XITANIUM 100W 4.1A 24V FIX INT -S	20	9290 007 71913

Accessories: Mounting profiles for PrimeSet RDL500

Type	Quantity per box	Ordering code
1200 mm length		
PrimeSet RDL-mount prof CTR 1200mm-47" B	12	9290 008 97706
PrimeSet RDL-mount prof SD 1200mm-47" B	12	9290 008 97806
1500 mm length		
PrimeSet RDL-mount prof CTR 1500mm-59" B	12	9290 008 94506
PrimeSet RDL-mount prof SD 1500mm-59" B	12	9290 008 95206
1700 mm length		
PrimeSet RDL-mount prof CTR 1700mm-67" B	12	9290 008 94606
PrimeSet RDL-mount prof SD 1700mm-67" B	12	9290 008 95306

© 2019 Signify Holding. All rights reserved. The information provided herein is subject to change, without notice. Signify does not give any representation or warranty as to the accuracy or completeness of the information included herein and shall not be liable for any action in reliance thereon. The information presented in this document is not intended as any commercial offer and does not form part of any quotation or contract, unless otherwise agreed by Signify.



www.philips.com/retaildisplaylighting

Philips and the Philips Shield Emblem are registered trademarks of Koninklijke Philips N.V. All other trademarks are owned by Signify Holding or their respective owners.