



Hadco FlexScope B9 accent line-voltage landscape luminaire has interchangeable optics 20°, 36° and 65° by switching optic lenses. This adjustable luminaire also has the ability to switch between 5 preset light outputs.

Project: _____
 Location: _____
 Cat.No: _____
 Type: _____
 Lamps: _____ Qty: _____
 Notes: _____

Ordering guide

example: B9DWA

Series	Lamping	CCT	Finish	Surge suppressor
B9	D	-		
B9 Accent line-voltage luminaire	D LED	W Warm (3000K) C Cool (4000K)	A Black H Bronze	blank None SP1 120-277V, 10K

Features

- Housing/Construction:** A360 die-cast aluminum, able to remove shroud from housing with 2 screws. Adjustable knuckle stem provides range of rotation, prevents fixture from pointing past vertical. Vibration locking teeth secured by black oxide stainless steel screw. Driver mounts directly to housing for thermal management. All gaskets 100% molded silicone.
- Electrical:** 34W (on high setting) Input voltage range (VAC) 120-277V. Pre-wired with 12"+ pig-tail for connection ease. Includes 0-10V Analog Class 2 wiring for dimming, capped off to help prevent cross wiring with line-voltage wires.
- Controls:** Class 2 driver with AOC and 0-10V dimming. Design allows easy-access to integral switch with 5 preset light outputs, see lumen matrix. Remove lens cap with [2] screws and simply adjust the slider switch by hand.
- LED Board:** Single COB LED Array.
- Optical Systems:** Flat glass, soda lime tempered clear glass, c-channel gasket slips onto lens without tools or RTV. Fixture pre-installed with medium flood (36°) optical lens. Interchangeable optical lenses clip onto main reflector. Both narrow flood (20°) and wide flood (65°) optical lenses are shipped with each fixture. Components are made of injection molded polycarbonate (PC).
- Mounting:** 1/2"-14 NPSM male threads to screw onto mounting stake, or other mounting accessory, sold separately.

Finish

Thermoset polyester powder coat is electrostatically applied after a five-stage conversion cleaning process and bonded by heat fusion thermosetting.

Lamps

Integral LED module

Options

Optional integral surge protection device provides single phase protection for line/neutral, line/ground, and neutral/ground in accordance with IEEE C62.41 2002C High.

IP66 Rating

Dust tight and sealed against direct jets of water.

Labels

ETL Listed to U.S. safety standards for wet locations. cETL listed to Canadian safety standards for wet locations. Manufactured to ISO 9001:2008 Standards. 5-year limited warranty.

Lumen matrix

Wattage	Amps		3000K			4000K		
	120V	277V	Narrow	Medium	Wide	Narrow	Medium	Wide
10W	80mA	50mA	995	982	932	1102	1097	1023
13W	110mA	55mA	1427	1409	1337	1580	1573	1467
19W	155mA	75mA	2031	2006	1903	2249	2240	2089
27W	225mA	100mA	2797	2762	2621	3097	3087	2874
33W	275mA	120mA	3271	3230	3065	3622	3598	3372

Light to go

Compatible configurations

Luminaire

B9BW-H



B9 FlexScape LED

Landscape line-voltage accent

Dimensions

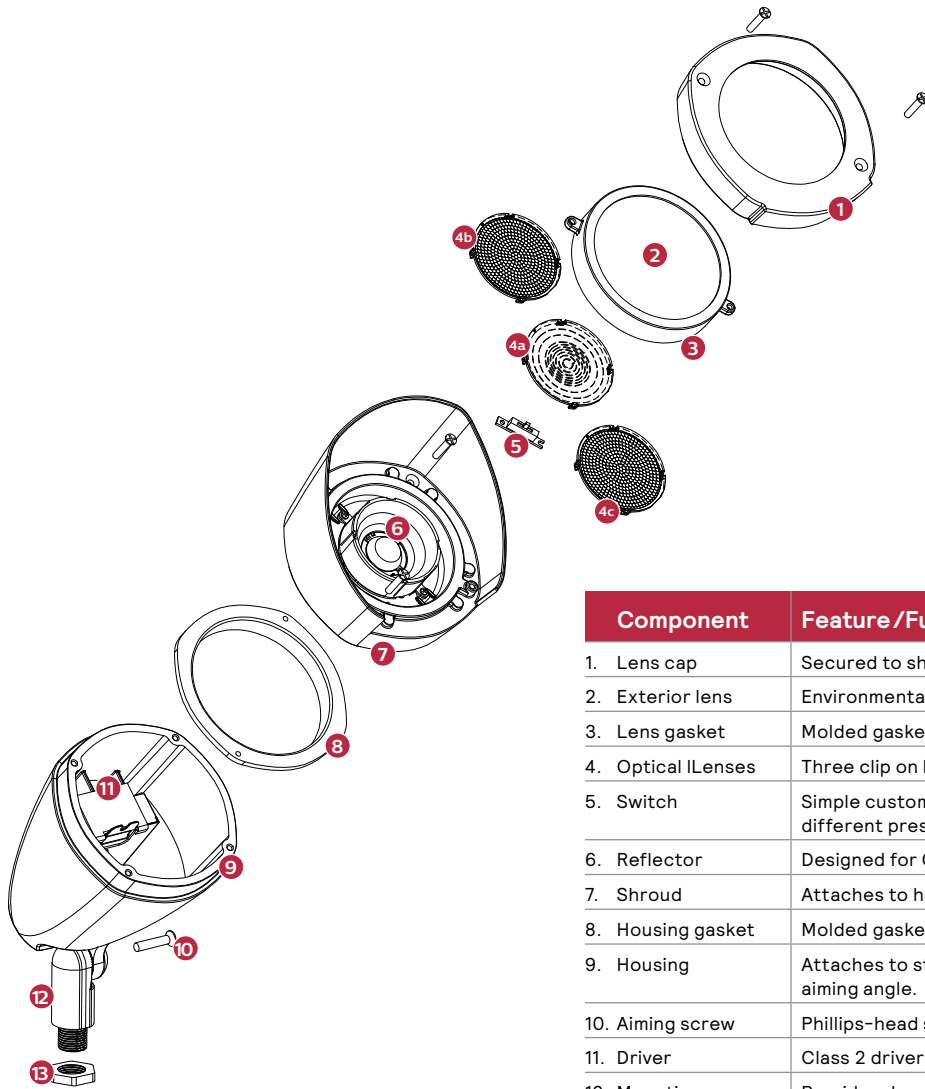
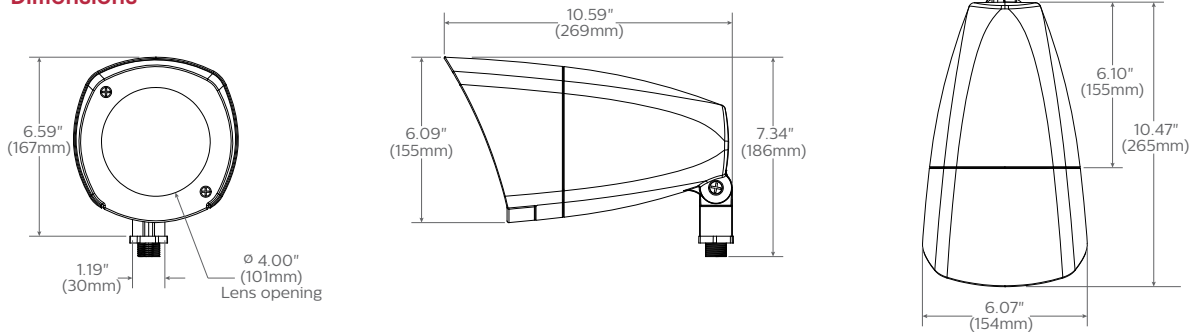

Component	Feature /Function
1. Lens cap	Secured to shroud with two phillips screws.
2. Exterior lens	Environmental barrier (sealing).
3. Lens gasket	Molded gasket slips onto lens without tools or RTV.
4. Optical ILenses	Three clip on lenses 4a - NFLD, 4b - MFLD, 4c -WFLD
5. Switch	Simple customer access for dimming. Slides to 5 different preset light levels.
6. Reflector	Designed for COB LEDs, provides UV protection.
7. Shroud	Attaches to housing with two screws.
8. Housing gasket	Molded gasket provides seal for driver housing.
9. Housing	Attaches to stem with screw, teeth to lock aiming angle.
10. Aiming screw	Phillips-head screw, loosen slightly to adjust aiming.
11. Driver	Class 2 driver with 0-10v dimming. Field replaceable.
12. Mounting arm	Provides durable mounting for luminaire, teeth to lock aiming angle.
13. Locking nut	Metal nut allows orientation of accent to be locked.

B9 FlexScape LED

Landscape line-voltage accent

B9 Warm 3000K

Narrow
minimum output

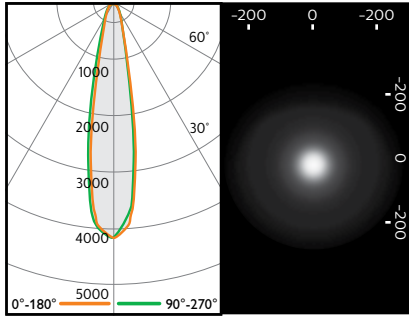

LRQL0422 SP L.O.R.= 1.00
(cd/1000lm)

Medium
minimum output

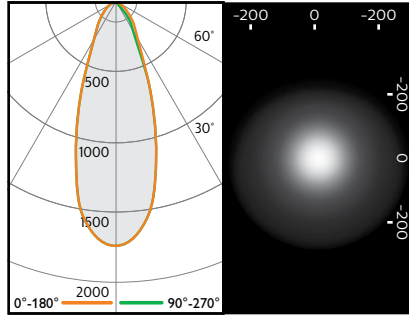

LRQL0372 M L.O.R.= 1.00
(cd/1000lm)

Wide
minimum output

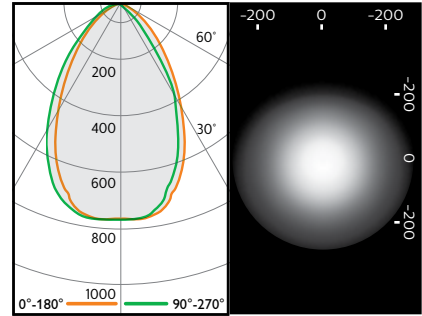

LRQL0421 W L.O.R.= 1.00
(cd/1000lm)

B9 Cool 4000K

Narrow
maximum output

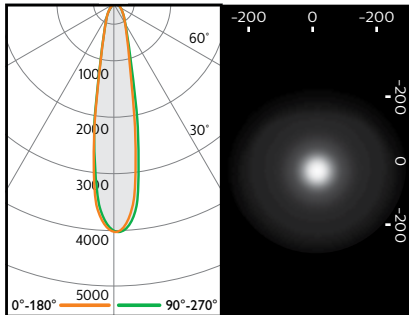

LRQL0411 SP L.O.R.= 1.00
(cd/1000lm)

Medium
maximum output

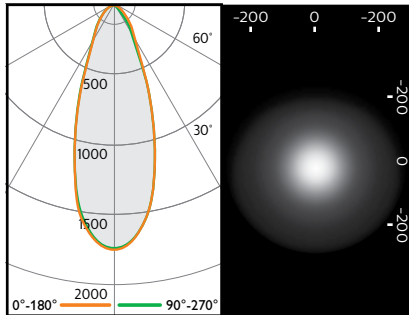

LRQL0374 M L.O.R.= 1.00
(cd/1000lm)

Wide
maximum output

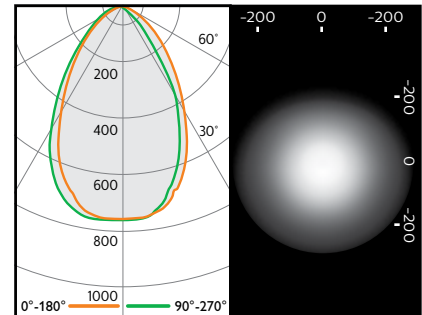

LRQL0415 W L.O.R.= 1.00
(cd/1000lm)

The information presented in this document is not intended as any commercial offer and does not form part of any quotation or contract.



© 2019 Signify Holding. All rights reserved. This document contains information relating to the product portfolio of Signify which information may be subject to change. No representation or warranty as to the accuracy or completeness of the information included herein is given and any liability for any action in reliance thereon is disclaimed. All trademarks are owned by Signify Holding or their respective owners.

Signify North America Corporation
200 Franklin Square Drive,
Somerset, NJ 08873
Telephone 855-486-2216

Signify Canada Ltd.
281 Hillmount Road,
Markham, ON, Canada L6C 2S3
Telephone 800-668-9008