



Lightolier LED retrofit downlight provides an easy and quick downlight solution without the traditional frame and reflector. Perfect for installation in existing ceilings or new construction with the benefits of energy saving LED technology.

Project: \_\_\_\_\_  
 Location: \_\_\_\_\_  
 Cat.No: \_\_\_\_\_  
 Type: \_\_\_\_\_  
 Lamps: \_\_\_\_\_ Qty: \_\_\_\_\_  
 Notes: \_\_\_\_\_

### Fixture

example: RD4R089301W

Family	Size	Lumens	CRI	CCT	Voltage	Finish
RD			9	30	1	W
RD Retrofit downlight	4R 4-inch Round	08 900 lm	9 90CRI	30 3000K	1 120V	W White (matte)
	5R 5/6-inch Round	12 1400 lm				

### Features

- Flange:** One piece self flange spun aluminum. White painted with baffle.
- Lens:** High transmittance lens allowing for smooth, comfortable light pattern.
- Power supply:** Integral class 2 driver. (see Electrical section for specifications)
- Friction spring:** Stainless steel.
- Lifetime:** L70 at 42,000 hours and backed with a 5-year warranty (see Philips.com/warranties for details).
- LED board:** Light emitted source.
- Power connection:** Trim features quick connect plug installed as standard. Trim ships with a medium base socket adapter whip for installation into incandescent housings with medium base sockets.

### Electrical

**Electronic power supply:** RoHS compliant. Class 2 power unit for use in a dry and damp locations.

**Dimming:** Intended for ELV/TRIAC (120V) dimming. For more details, please see LED-DIM-DL spec sheet.

### Labels

cULus classified.  
 Title 24 (JA8-2016).  
 ENERGY STAR®.  
 Wet Location.  
 IC rated.

Electrical specs	Dimming	Nominal Lumens	Input volts	Input freq.	Input current	Input Power	THD Factor	Power Factor	Minimum Operating Temp.	Maximum Operating Temp.
RD4R	ELV/TRIAC	900lm	120V	60Hz	114A	13W	<35%	>0.9	-20°C	40°C
RD5R	ELV/TRIAC	1400lm	120V	60Hz	161A	18.5W	<30%	>0.9	-20°C	40°C

## Light to go

Compatible configurations

Fixture

RD4R089301W  
 RD5R129301W

every job matters



# RD Retrofit Downlight

## Round 4" & 5/6" Apertures

### Compatibility

Installs into IC or Non-IC rough in sections with cylindrical recessed metal housings.

#### RD4R series

Manufacturer	Model	
Philips	CP4RN	
	CP4RR	
	FDIC4V50	
	P4	
	P4R	
	P4ASIC	
	P4GU	
	P4RGU	
	R4	
	RR4	
	R4ASICG	
	Halo	H991CAT
		H99T
H99RT		
Seagull	1179	
	1105	
All-Pro	E1400AT5B	

#### RD5R series

Manufacturer	Model
Philips	CP6RN 1104IC
	CP6RR 1004IC
	CR1NBQP 1004ICN
	QL6NBQP 1004ICNQ
	P6GU 1004ICNS
	P6RGU 1004ICQ
	PR75ASIC 1004ICN
	PRR75ICX
	FD2IC6V90
	Halo
H7RT,	
H7ICAT,	
H7RICAT	
Lithonia	L7X
Juno	IC22
Progress	P87-A1

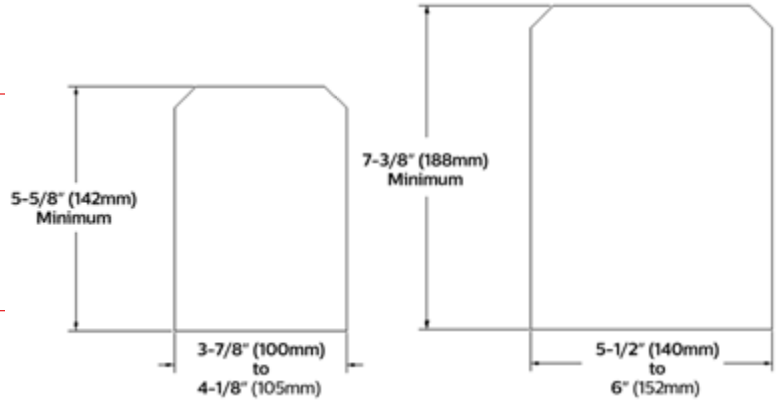

**RD4R Series**, minimum 3-7/8" (100mm) to maximum 4-1/8" (105mm) diameter and 5-5/8" (142mm) height

**RD5R Series**, minimum 5-1/2" (140mm) to maximum 6" (152mm) diameter and 7-3/8" (188mm) height

### Dimensions

#### Retrofit downlight 4"

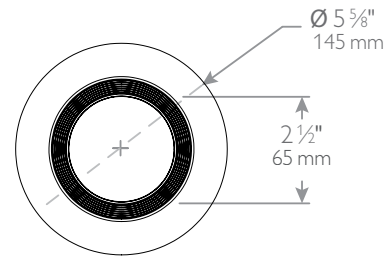
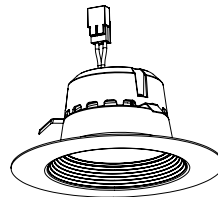
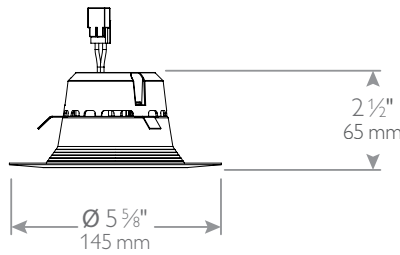

#### Retrofit downlight 5/6"

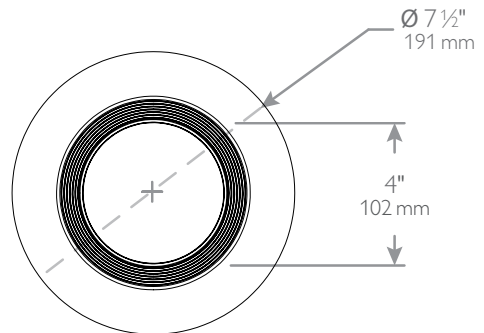
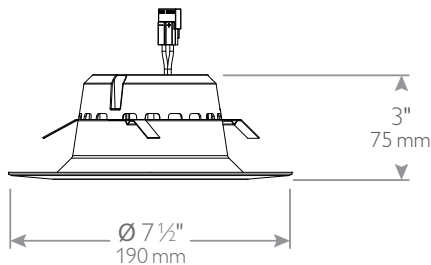

# RD Retrofit Downlight

## Round 4" & 5/6" Apertures

### 4-inch, 12W, 76.4lm/W

Candela Curve

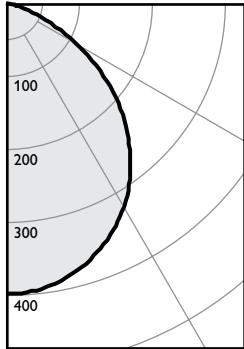

Angle	Mean CP	Lumens
0	397	
5	395	37
10	388	
15	377	106
20	361	
25	342	158
30	320	
35	293	184
40	261	
45	227	181
50	190	
55	150	145
60	108	
65	67	82
70	32	
75	11	21
80	5	
85	1	3
90	0	

Single unit data

Height to Lighted Plane	Initial center beam foot-candles	Beam dia. (ft)*
5'	16	6.0'
6'	11	7.2'
7'	8	8.4'
8'	6	9.6'
9'	5	10.8'

\* Beam diameter is where foot-candles drop to 50% of maximum.

Multiple unit data - RCR 2

Spacing on center	Initial center beam foot-candles	Watts per sq.ft.
5'	38.3	0.53
6'	25.2	0.35
7'	18.0	0.25
8'	15.0	0.21
9'	12.0	0.17

38'x38'x10' Room, Workplane 2.5' above floor, 80/50/20% Reflectances

Coefficients of utilization

Ceiling	80%				70%		50%		30%		0%	
	70	50	30	10	50	10	50	10	50	10	0	
Wall	Zonal cavity method - Effective floor reflectance = 20%											
RCR	Zonal cavity method - Effective floor reflectance = 20%											
Room Cavity Ratio	0	119	119	119	119	116	116	111	111	106	106	100
	1	111	107	103	100	104	98	100	95	96	92	87
	2	102	95	89	84	93	83	89	81	86	79	75
	3	94	84	77	71	83	70	80	69	77	68	65
	4	86	75	67	61	74	61	71	60	69	59	56
	5	79	68	59	53	66	53	64	52	63	52	49
	6	74	61	53	47	60	47	58	46	57	46	43
	7	68	56	47	42	55	41	53	41	52	41	39
	8	64	51	43	37	50	37	49	37	48	37	35
	9	60	47	39	34	46	34	45	33	44	33	31
	10	56	43	36	31	43	31	42	30	41	30	28

Zonal lumens & percentages

Zone	Lumens	%Luminaire
0-30	302	32.9%
0-40	486	53.0%
0-60	812	88.5%
0-90	917	100.0%

Report#: RD4R089301W

Output lumens:	917lms	Efficacy:	76.4lm/w
Spacing Criterion:	1.2	CCT <sup>3</sup> :	3000K
Input Watts <sup>2</sup> :	12W	CRI:	90min

### 5/6-inch, 18W, 78.4lm/W

Candela Curve

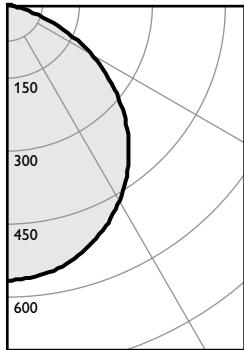

Angle	Mean CP	Lumens
0	564	
5	561	53
10	552	
15	538	152
20	517	
25	492	227
30	463	
35	429	270
40	390	
45	347	272
50	300	
55	250	232
60	197	
65	139	151
70	80	
75	30	49
80	8	
85	3	4
90	0	

Single unit data

Height to Lighted Plane	Initial center beam foot-candles	Beam dia. (ft)*
5'	23	6.0'
6'	16	7.2'
7'	12	8.4'
8'	9	9.6'
9'	7	10.8'

\* Beam diameter is where foot-candles drop to 50% of maximum.

Multiple unit data - RCR 2

Spacing on center	Initial center beam foot-candles	Watts per sq.ft.
5'	58.3	0.80
6'	38.3	0.52
7'	27.3	0.37
8'	22.8	0.31
9'	18.2	0.25

38'x38'x10' Room, Workplane 2.5' above floor, 80/50/20% Reflectances

Coefficients of utilization

Ceiling	80%				70%		50%		30%		0%	
	70	50	30	10	50	10	50	10	50	10	0	
Wall	Zonal cavity method - Effective floor reflectance = 20%											
RCR	Zonal cavity method - Effective floor reflectance = 20%											
Room Cavity Ratio	0	119	119	119	119	116	116	111	111	106	106	100
	1	110	106	102	99	104	97	99	94	96	91	87
	2	101	93	87	82	92	81	88	79	85	77	74
	3	92	83	75	69	81	68	78	67	75	66	63
	4	85	74	65	59	72	58	70	58	67	57	54
	5	78	66	57	51	65	51	63	50	61	50	47
	6	72	59	51	45	59	44	57	44	55	44	41
	7	67	54	46	40	53	39	52	39	50	39	37
	8	62	49	41	35	49	35	47	35	46	35	33
	9	58	45	37	32	45	32	44	32	43	31	30
	10	55	42	34	29	41	29	40	29	39	29	27

Zonal lumens & percentages

Zone	Lumens	%Luminaire
0-30	433	30.6%
0-40	702	49.8%
0-60	1206	85.5%
0-90	1411	100.0%

Report#: RD5R129301W

Output lumens:	1411lms	Efficacy:	78.4lm/w
Spacing Criterion:	1.2	CCT <sup>3</sup> :	3000K
Input Watts <sup>2</sup> :	18W	CRI:	90min

1. Tested using absolute photometry as specified in LM79: IESNA Approved Method for the Electrical and Photometric Measurements of Solid-State Lighting Products.
2. Wattage: controlled to within 5%
3. Correlated Color Temperature: within specs as defined in ANSI\_NEMA\_ANSI C78.377-2008: Specifications for the Chromaticity of Solid State Lighting Products.

