



# The Perfect LED Spot solution

## LED MR16

Philips LED MR-16 lamps with single optic technology provide the look and color quality of traditional halogens while using a fraction of the energy. A perfect fit for spot lighting, they are compatible with most existing fixtures with MR16 GU5.3 holders and are designed as a retrofit replacement for halogen or incandescent spots.

### Benefits

- Up to 80% energy saving compared with halogen lamps and lower maintenance costs
- Easy to replace/retro-fit. Broad compatibility with transformers
- “Perfect fit” in most current Halogen fixtures

### Features

- Ranging between 15,000 to 40,000 hour LED Lifetime
- Easy to replace/retro-fit- “Perfect fit” in most current Halogen fixtures. Title 20 & Title 24 JA8 compliant versions options are available
- Optimized look and feel of product
- Compatible with most commonly available halogen transformers
- Ranging between 3-year to 5-year limited component warranty depending upon operating hours

### Application

- Hotels, restaurants, bars, cafés, museums, shops
- Lobbies, corridors, stairwells, washrooms, reception areas , exhibitions, display cabinets

## Light to go

Compatible configurations

Lamps

7.3MR16/LED/827/F35/DIM 12V 10/1FB  
7.3MR16/LED/830/F35/DIM 12V 10/1FB  
7.3MR16/LED/830/F25/DIM 12V 10/1FB  
7.3MR16/LED/827/F25/DIM 12V 10/1FB

every  
job matters

# LED MR16

## Versions



GU5.3 MR16



GU5.3 MR16



GU5.3 MR16



GU5.3 MR16



GU5.3 MR16



GU5.3 MR16

# LED MR16

## Dimensional drawing

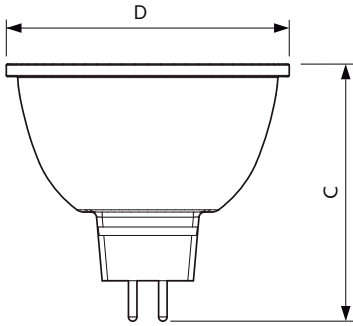

| Product                                 | D       | C       |
|---|---------|---------|
| 6.5MR16/LED/F25/930/D/EC/12V T20 10/1FB | 50.5 mm | 46 mm   |
| 6.5MR16/LED/F35/927/D/EC/12V T20 10/1FB | 50.5 mm | 46 mm   |
| 6.5MR16/LED/F25/927/D/EC/12V T20 10/1FB | 50.5 mm | 46 mm   |
| 8.5MR16/LED/830/F35/DIM 12V 10/1FB      | 50.5 mm | 46.5 mm |
| 8.5MR16/LED/827/F35/DIM 12V 10/1FB      | 50.5 mm | 46.5 mm |
| 8.5MR16/LED/840/F35/DIM 12V 10/1FB      | 50.5 mm | 46.5 mm |
| 7.3MR16/LED/827/F35/DIM 12V 10/1FB      | 50.5 mm | 46.5 mm |
| 7.3MR16/LED/830/F35/DIM 12V 10/1FB      | 50.5 mm | 46.5 mm |
| 8.5MR16/LED/840/F25/DIM 12V 10/1FB      | 50.5 mm | 46.5 mm |
| 7.3MR16/LED/827/F25/DIM 12V 10/1FB      | 50.5 mm | 46.5 mm |
| 8.5MR16/LED/827/F25/DIM 12V 10/1FB      | 50.5 mm | 46.5 mm |
| 8.5MR16/LED/830/F25/DIM 12V 10/1FB      | 50.5 mm | 46.5 mm |
| 7.3MR16/LED/830/F25/DIM 12V 10/1FB      | 50.5 mm | 46.5 mm |
| 7MR16 ExpertColor Retail S10 930 10/1   | 51 mm   | 46 mm   |
| 7MR16 ExpertColor Retail F35 930 10/1   | 51 mm   | 46 mm   |
| 7.8MR16/PER/927/F35/Dim/EC/12V 10/1FB   | 51 mm   | 46 mm   |
| 7.8MR16/PER/940/F35/Dim/EC/12V 10/1FB   | 51 mm   | 46 mm   |
| 7.8MR16/PER/930/F35/Dim/EC/12V 10/1FB   | 51 mm   | 46 mm   |
| 7.8MR16/PER/927/F25/Dim/EC/12V 10/1FB   | 51 mm   | 46 mm   |
| 7.8MR16/PER/940/F25/Dim/EC/12V 10/1FB   | 51 mm   | 46 mm   |
| 7.8MR16/PER/930/F25/Dim/EC/12V 10/1FB   | 51 mm   | 46 mm   |
| 7.8MR16/PER/940/S10/Dim/EC/12V 10/1FB   | 51 mm   | 46 mm   |
| 7.8MR16/PER/930/S10/Dim/EC/12V 10/1FB   | 51 mm   | 46 mm   |
| 7.8MR16/PER/927/S10/Dim/EC/12V 10/1FB   | 51 mm   | 46 mm   |
| 6.5MR16/LED/F35/930/D/EC/12V T20 10/1FB | 50.5 mm | 46 mm   |

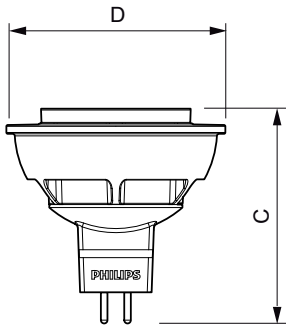

| Product                       | D     | C     |
|-------------------------------|-------|-------|
| 6.4MR16/F35/3000 DIM 12V      | 51 mm | 51 mm |
| 6.4MR16/F25/3000 DIM 12V      | 51 mm | 51 mm |
| 6.5MR16/F35/2700-2200 DIM 12V | 51 mm | 50 mm |
| 6.5MR16/F25/2700-2200 DIM 12V | 51 mm | 50 mm |

### General Information

|                 |        |
|-----------------|--------|
| Cap-Base        | GU5.3  |
| Switching Cycle | 50000X |

### Light Technical

|                                       |      |
|---------------------------------------|------|
| Llmf At End Of Nominal Lifetime (Nom) | 70 % |
|---------------------------------------|------|

### Mechanical and Housing

|            |      |
|------------|------|
| Bulb Shape | MR16 |
|------------|------|

## Approval and Application

## LED MR16

| Order Code | Full Product Name                       | Energy Consumption kWh/1000 h | Energy Efficiency Label (EEL) |
|------------|---|-------------------------------|-------------------------------|
| 454538     | 6.5MR16/F25/2700-2200 DIM 12V 10/1      | - kWh                         | Not applicable                |
| 454546     | 6.5MR16/F35/2700-2200 DIM 12V 10/1      | 7 kWh                         | Not applicable                |
| 470336     | 6.4MR16/F25/3000 DIM 12V 10/1           | -                             | Not applicable                |
| 470344     | 6.4MR16/F35/3000 DIM 12V 10/1           | -                             | Not applicable                |
| 470229     | 7MR16 ExpertColor Retail S10 930 10/1   | -                             | -                             |
| 479139     | 6.5MR16/LED/F25/927/D/EC/12V T20 10/1FB | -                             | -                             |
| 479147     | 6.5MR16/LED/F25/930/D/EC/12V T20 10/1FB | -                             | -                             |
| 479162     | 6.5MR16/LED/F35/927/D/EC/12V T20 10/1FB | -                             | -                             |
| 479170     | 6.5MR16/LED/F35/930/D/EC/12V T20 10/1FB | -                             | -                             |
| 470138     | 7.8MR16/PER/927/S10/Dim/EC/12V 10/1FB   | -                             | -                             |
| 470146     | 7.8MR16/PER/930/S10/Dim/EC/12V 10/1FB   | -                             | -                             |
| 470153     | 7.8MR16/PER/940/S10/Dim/EC/12V 10/1FB   | -                             | -                             |
| 470161     | 7.8MR16/PER/927/F25/Dim/EC/12V 10/1FB   | -                             | -                             |

| Order Code | Full Product Name                     | Energy Consumption kWh/1000 h | Energy Efficiency Label (EEL) |
|------------|---------------------------------------|-------------------------------|-------------------------------|
| 470179     | 7.8MR16/PER/930/F25/Dim/EC/12V 10/1FB | -                             | -                             |
| 470187     | 7.8MR16/PER/940/F25/Dim/EC/12V 10/1FB | -                             | -                             |
| 470195     | 7.8MR16/PER/927/F35/Dim/EC/12V 10/1FB | -                             | -                             |
| 470203     | 7.8MR16/PER/930/F35/Dim/EC/12V 10/1FB | -                             | -                             |
| 470211     | 7.8MR16/PER/940/F35/Dim/EC/12V 10/1FB | -                             | -                             |
| 470245     | 7MR16 ExpertColor Retail F35 930 10/1 | -                             | -                             |
| 533117     | 7.3MR16/LED/827/F25/DIM 12V 10/1FB    | -                             | -                             |
| 533125     | 7.3MR16/LED/830/F25/DIM 12V 10/1FB    | -                             | -                             |
| 533141     | 7.3MR16/LED/827/F35/DIM 12V 10/1FB    | -                             | -                             |
| 533158     | 7.3MR16/LED/830/F35/DIM 12V 10/1FB    | -                             | -                             |
| 533182     | 8.5MR16/LED/827/F35/DIM 12V 10/1FB    | -                             | -                             |
| 533190     | 8.5MR16/LED/830/F35/DIM 12V 10/1FB    | -                             | -                             |
| 533331     | 8.5MR16/LED/840/F35/DIM 12V 10/1FB    | -                             | -                             |
| 533513     | 8.5MR16/LED/827/F25/DIM 12V 10/1FB    | -                             | -                             |
| 533174     | 8.5MR16/LED/830/F25/DIM 12V 10/1FB    | -                             | -                             |
| 533521     | 8.5MR16/LED/840/F25/DIM 12V 10/1FB    | -                             | -                             |

### Controls and Dimming

| Order Code | Full Product Name                       | Dimmable |
|------------|---|----------|
| 454538     | 6.5MR16/F25/2700-2200 DIM 12V 10/1      | Yes      |
| 454546     | 6.5MR16/F35/2700-2200 DIM 12V 10/1      | Yes      |
| 470336     | 6.4MR16/F25/3000 DIM 12V 10/1           | Yes      |
| 470344     | 6.4MR16/F35/3000 DIM 12V 10/1           | Yes      |
| 470229     | 7MR16 ExpertColor Retail S10 930 10/1   | No       |
| 479139     | 6.5MR16/LED/F25/927/D/EC/12V T20 10/1FB | Yes      |
| 479147     | 6.5MR16/LED/F25/930/D/EC/12V T20 10/1FB | Yes      |
| 479162     | 6.5MR16/LED/F35/927/D/EC/12V T20 10/1FB | Yes      |
| 479170     | 6.5MR16/LED/F35/930/D/EC/12V T20 10/1FB | Yes      |
| 470138     | 7.8MR16/PER/927/S10/Dim/EC/12V 10/1FB   | Yes      |
| 470146     | 7.8MR16/PER/930/S10/Dim/EC/12V 10/1FB   | Yes      |
| 470153     | 7.8MR16/PER/940/S10/Dim/EC/12V 10/1FB   | Yes      |
| 470161     | 7.8MR16/PER/927/F25/Dim/EC/12V 10/1FB   | Yes      |
| 470179     | 7.8MR16/PER/930/F25/Dim/EC/12V 10/1FB   | Yes      |
| 470187     | 7.8MR16/PER/940/F25/Dim/EC/12V 10/1FB   | Yes      |

| Order Code | Full Product Name                     | Dimmable |
|------------|---------------------------------------|----------|
| 470195     | 7.8MR16/PER/927/F35/Dim/EC/12V 10/1FB | Yes      |
| 470203     | 7.8MR16/PER/930/F35/Dim/EC/12V 10/1FB | Yes      |
| 470211     | 7.8MR16/PER/940/F35/Dim/EC/12V 10/1FB | Yes      |
| 470245     | 7MR16 ExpertColor Retail F35 930 10/1 | No       |
| 533117     | 7.3MR16/LED/827/F25/DIM 12V 10/1FB    | Yes      |
| 533125     | 7.3MR16/LED/830/F25/DIM 12V 10/1FB    | Yes      |
| 533141     | 7.3MR16/LED/827/F35/DIM 12V 10/1FB    | Yes      |
| 533158     | 7.3MR16/LED/830/F35/DIM 12V 10/1FB    | Yes      |
| 533182     | 8.5MR16/LED/827/F35/DIM 12V 10/1FB    | Yes      |
| 533190     | 8.5MR16/LED/830/F35/DIM 12V 10/1FB    | Yes      |
| 533331     | 8.5MR16/LED/840/F35/DIM 12V 10/1FB    | Yes      |
| 533513     | 8.5MR16/LED/827/F25/DIM 12V 10/1FB    | Yes      |
| 533174     | 8.5MR16/LED/830/F25/DIM 12V 10/1FB    | Yes      |
| 533521     | 8.5MR16/LED/840/F25/DIM 12V 10/1FB    | Yes      |

### Operating and Electrical

| Order Code | Full Product Name                     | Input Frequency | Voltage (Nom) | Wattage Equivalent | Power (Rated) (Nom) | Starting Time (Nom) |
|------------|---------------------------------------|-----------------|---------------|--------------------|---------------------|---------------------|
| 454538     | 6.5MR16/F25/2700-2200 DIM 12V 10/1    | 50 to 60 Hz     | 12 V          | -                  | 6.5 W               | 0.5 s               |
| 454546     | 6.5MR16/F35/2700-2200 DIM 12V 10/1    | 50 to 60 Hz     | 12 V          | -                  | 6.5 W               | 0.5 s               |
| 470336     | 6.4MR16/F25/3000 DIM 12V 10/1         | -               | 12 V          | 35 W               | 6.4 W               | 0.5 s               |
| 470344     | 6.4MR16/F35/3000 DIM 12V 10/1         | -               | 12 V          | 35 W               | 6.4 W               | 0.6 s               |
| 470229     | 7MR16 ExpertColor Retail S10 930 10/1 | -               | 12 V          | 30 W               | 7 W                 | 0.5 s               |

## LED MR16

| Order Code | Full Product Name                       | Input Frequency | Voltage (Nom)      | Wattage Equivalent | Power (Rated) (Nom) | Starting Time (Nom) |
|------------|---|-----------------|--------------------|--------------------|---------------------|---------------------|
| 479139     | 6.5MR16/LED/F25/927/D/EC/12V T20 10/1FB | -               | ac electronic 12 V | 42 W               | 6.5 W               | 0.5 s               |
| 479147     | 6.5MR16/LED/F25/930/D/EC/12V T20 10/1FB | -               | ac electronic 12 V | 42 W               | 6.5 W               | 0.5 s               |
| 479162     | 6.5MR16/LED/F35/927/D/EC/12V T20 10/1FB | -               | ac electronic 12 V | 42 W               | 6.5 W               | 0.5 s               |
| 479170     | 6.5MR16/LED/F35/930/D/EC/12V T20 10/1FB | -               | ac electronic 12 V | 42 W               | 6.5 W               | 0.5 s               |
| 470138     | 7.8MR16/PER/927/S10/Dim/EC/12V 10/1FB   | -               | ac electronic 12 V | 35 W               | 7.8 W               | 0.5 s               |
| 470146     | 7.8MR16/PER/930/S10/Dim/EC/12V 10/1FB   | -               | ac electronic 12 V | 35 W               | 7.8 W               | 0.5 s               |
| 470153     | 7.8MR16/PER/940/S10/Dim/EC/12V 10/1FB   | -               | ac electronic 12 V | 35 W               | 7.8 W               | 0.5 s               |
| 470161     | 7.8MR16/PER/927/F25/Dim/EC/12V 10/1FB   | -               | ac electronic 12 V | 50 W               | 7.8 W               | 0.5 s               |
| 470179     | 7.8MR16/PER/930/F25/Dim/EC/12V 10/1FB   | -               | ac electronic 12 V | 50 W               | 7.8 W               | 0.5 s               |
| 470187     | 7.8MR16/PER/940/F25/Dim/EC/12V 10/1FB   | -               | ac electronic 12 V | 50 W               | 7.8 W               | 0.5 s               |
| 470195     | 7.8MR16/PER/927/F35/Dim/EC/12V 10/1FB   | -               | ac electronic 12 V | 50 W               | 7.8 W               | 0.5 s               |
| 470203     | 7.8MR16/PER/930/F35/Dim/EC/12V 10/1FB   | -               | ac electronic 12 V | 50 W               | 7.8 W               | 0.5 s               |
| 470211     | 7.8MR16/PER/940/F35/Dim/EC/12V 10/1FB   | -               | ac electronic 12 V | 50 W               | 7.8 W               | 0.5 s               |
| 470245     | 7MR16 ExpertColor Retail F35 930 10/1   | -               | 12 V               | 42 W               | 7 W                 | 0.5 s               |
| 533117     | 7.3MR16/LED/827/F25/DIM 12V 10/1FB      | -               | ac electronic 12 V | 50 W               | 7.3 W               | 0.5 s               |
| 533125     | 7.3MR16/LED/830/F25/DIM 12V 10/1FB      | -               | ac electronic 12 V | 50 W               | 7.3 W               | 0.5 s               |
| 533141     | 7.3MR16/LED/827/F35/DIM 12V 10/1FB      | -               | ac electronic 12 V | 50 W               | 7.3 W               | 0.5 s               |
| 533158     | 7.3MR16/LED/830/F35/DIM 12V 10/1FB      | -               | ac electronic 12 V | 50 W               | 7.3 W               | 0.5 s               |
| 533182     | 8.5MR16/LED/827/F35/DIM 12V 10/1FB      | -               | ac electronic 12 V | 75 W               | 8.5 W               | 0.5 s               |
| 533190     | 8.5MR16/LED/830/F35/DIM 12V 10/1FB      | -               | ac electronic 12 V | 75 W               | 8.5 W               | 0.5 s               |
| 533331     | 8.5MR16/LED/840/F35/DIM 12V 10/1FB      | -               | ac electronic 12 V | 75 W               | 8.5 W               | 0.5 s               |
| 533513     | 8.5MR16/LED/827/F25/DIM 12V 10/1FB      | -               | ac electronic 12 V | 75 W               | 8.5 W               | 0.5 s               |
| 533174     | 8.5MR16/LED/830/F25/DIM 12V 10/1FB      | -               | ac electronic 12 V | 75 W               | 8.5 W               | 0.5 s               |
| 533521     | 8.5MR16/LED/840/F25/DIM 12V 10/1FB      | -               | ac electronic 12 V | 75 W               | 8.5 W               | 0.5 s               |

### General Information

| Order Code | Full Product Name                       | Nominal Lifetime (Nom) | Order Code | Full Product Name                     | Nominal Lifetime (Nom) |
|------------|---|------------------------|------------|---------------------------------------|------------------------|
| 454538     | 6.5MR16/F25/2700-2200 DIM 12V 10/1      | 25000 h                | 470195     | 7.8MR16/PER/927/F35/Dim/EC/12V 10/1FB | 25000 h                |
| 454546     | 6.5MR16/F35/2700-2200 DIM 12V 10/1      | 25000 h                | 470203     | 7.8MR16/PER/930/F35/Dim/EC/12V 10/1FB | 25000 h                |
| 470336     | 6.4MR16/F25/3000 DIM 12V 10/1           | 25000 h                | 470211     | 7.8MR16/PER/940/F35/Dim/EC/12V 10/1FB | 25000 h                |
| 470344     | 6.4MR16/F35/3000 DIM 12V 10/1           | 25000 h                | 470245     | 7MR16 ExpertColor Retail F35 930 10/1 | 40000 h                |
| 470229     | 7MR16 ExpertColor Retail S10 930 10/1   | 40000 h                | 533117     | 7.3MR16/LED/827/F25/DIM 12V 10/1FB    | 25000 h                |
| 479139     | 6.5MR16/LED/F25/927/D/EC/12V T20 10/1FB | 25000 h                | 533125     | 7.3MR16/LED/830/F25/DIM 12V 10/1FB    | 25000 h                |
| 479147     | 6.5MR16/LED/F25/930/D/EC/12V T20 10/1FB | 25000 h                | 533141     | 7.3MR16/LED/827/F35/DIM 12V 10/1FB    | 25000 h                |
| 479162     | 6.5MR16/LED/F35/927/D/EC/12V T20 10/1FB | 25000 h                | 533158     | 7.3MR16/LED/830/F35/DIM 12V 10/1FB    | 25000 h                |
| 479170     | 6.5MR16/LED/F35/930/D/EC/12V T20 10/1FB | 25000 h                | 533182     | 8.5MR16/LED/827/F35/DIM 12V 10/1FB    | 25000 h                |
| 470138     | 7.8MR16/PER/927/S10/Dim/EC/12V 10/1FB   | 25000 h                | 533190     | 8.5MR16/LED/830/F35/DIM 12V 10/1FB    | 25000 h                |
| 470146     | 7.8MR16/PER/930/S10/Dim/EC/12V 10/1FB   | 25000 h                | 533331     | 8.5MR16/LED/840/F35/DIM 12V 10/1FB    | 25000 h                |
| 470153     | 7.8MR16/PER/940/S10/Dim/EC/12V 10/1FB   | 25000 h                | 533513     | 8.5MR16/LED/827/F25/DIM 12V 10/1FB    | 25000 h                |
| 470161     | 7.8MR16/PER/927/F25/Dim/EC/12V 10/1FB   | 25000 h                | 533174     | 8.5MR16/LED/830/F25/DIM 12V 10/1FB    | 25000 h                |
| 470179     | 7.8MR16/PER/930/F25/Dim/EC/12V 10/1FB   | 25000 h                | 533521     | 8.5MR16/LED/840/F25/DIM 12V 10/1FB    | 25000 h                |
| 470187     | 7.8MR16/PER/940/F25/Dim/EC/12V 10/1FB   | 25000 h                |            |                                       |                        |

### Light Technical

| Order Code | Full Product Name                  | Beam Angle | Correlated Color |                   | Color Rendering |                     | Luminous Intensity |
|------------|------------------------------------|------------|------------------|-------------------|-----------------|---------------------|--------------------|
|            |                                    | (Nom)      | Color Code       | Temperature (Nom) | Index (Nom)     | Luminous Flux (Nom) | (Nom)              |
| 454538     | 6.5MR16/F25/2700-2200 DIM 12V 10/1 | 25 °       | 822-827          | 2200-2700 K       | 80              | 410 lm              | 1800 cd            |
| 454546     | 6.5MR16/F35/2700-2200 DIM 12V 10/1 | 35 °       | 822-827          | 2200-2700 K       | 80              | 410 lm              | 900 cd             |
| 470336     | 6.4MR16/F25/3000 DIM 12V 10/1      | 25 °       | 830              | 3000 K            | 80              | 450 lm              | 1800 cd            |

## LED MR16

| Order Code | Full Product Name                       | Beam Angle | Correlated Color |                   | Color Rendering |                     | Luminous Intensity |
|------------|---|------------|------------------|-------------------|-----------------|---------------------|--------------------|
|            |   | (Nom)      | Color Code       | Temperature (Nom) | Index (Nom)     | Luminous Flux (Nom) | (Nom)              |
| 470344     | 6.4MR16/F35/3000 DIM 12V 10/1           | 35 °       | 830              | 3000 K            | 80              | 450 lm              | 1000 cd            |
| 470229     | 7MR16 ExpertColor Retail S10 930 10/1   | 10 °       | 930              | 3000 K            | 90              | 430 lm              | 4600 cd            |
| 479139     | 6.5MR16/LED/F25/927/D/EC/12V T20 10/1FB | 25 °       | 927              | 2700 K            | 91              | 485 lm              | 1960 cd            |
| 479147     | 6.5MR16/LED/F25/930/D/EC/12V T20 10/1FB | 25 °       | 930              | 3000 K            | 91              | 485 lm              | 1960 cd            |
| 479162     | 6.5MR16/LED/F35/927/D/EC/12V T20 10/1FB | 35 °       | 927              | 2700 K            | 91              | 485 lm              | 1110 cd            |
| 479170     | 6.5MR16/LED/F35/930/D/EC/12V T20 10/1FB | 35 °       | 930              | 3000 K            | 91              | 485 lm              | 1110 cd            |
| 470138     | 7.8MR16/PER/927/S10/Dim/EC/12V 10/1FB   | 10 °       | 927              | 2700 K            | 95              | 480 lm              | 5300 cd            |
| 470146     | 7.8MR16/PER/930/S10/Dim/EC/12V 10/1FB   | 10 °       | 930              | 3000 K            | 95              | 480 lm              | 5300 cd            |
| 470153     | 7.8MR16/PER/940/S10/Dim/EC/12V 10/1FB   | 10 °       | 940              | 4000 K            | 95              | 540 lm              | 5900 cd            |
| 470161     | 7.8MR16/PER/927/F25/Dim/EC/12V 10/1FB   | 25 °       | 927              | 2700 K            | 95              | 480 lm              | 2330 cd            |
| 470179     | 7.8MR16/PER/930/F25/Dim/EC/12V 10/1FB   | 25 °       | 930              | 3000 K            | 95              | 480 lm              | 2330 cd            |
| 470187     | 7.8MR16/PER/940/F25/Dim/EC/12V 10/1FB   | 25 °       | 940              | 4000 K            | 95              | 540 lm              | 2600 cd            |
| 470195     | 7.8MR16/PER/927/F35/Dim/EC/12V 10/1FB   | 35 °       | 927              | 2700 K            | 95              | 480 lm              | 1320 cd            |
| 470203     | 7.8MR16/PER/930/F35/Dim/EC/12V 10/1FB   | 35 °       | 930              | 3000 K            | 95              | 480 lm              | 1320 cd            |
| 470211     | 7.8MR16/PER/940/F35/Dim/EC/12V 10/1FB   | 35 °       | 940              | 4000 K            | 95              | 540 lm              | 1450 cd            |
| 470245     | 7MR16 ExpertColor Retail F35 930 10/1   | 35 °       | 930              | 3000 K            | 90              | 430 lm              | 1300 cd            |
| 533117     | 7.3MR16/LED/827/F25/DIM 12V 10/1FB      | 25 °       | 827              | 2700 K            | 80              | 515 lm              | 2400 cd            |
| 533125     | 7.3MR16/LED/830/F25/DIM 12V 10/1FB      | 25 °       | 830              | 3000 K            | 80              | 515 lm              | 2500 cd            |
| 533141     | 7.3MR16/LED/827/F35/DIM 12V 10/1FB      | 35 °       | 827              | 2700 K            | 80              | 515 lm              | 1350 cd            |
| 533158     | 7.3MR16/LED/830/F35/DIM 12V 10/1FB      | 35 °       | 830              | 3000 K            | 80              | 515 lm              | 1350 cd            |
| 533182     | 8.5MR16/LED/827/F35/DIM 12V 10/1FB      | 35 °       | 827              | 2700 K            | 80              | 600 lm              | 1700 cd            |
| 533190     | 8.5MR16/LED/830/F35/DIM 12V 10/1FB      | 35 °       | 830              | 3000 K            | 80              | 620 lm              | 1700 cd            |
| 533331     | 8.5MR16/LED/840/F35/DIM 12V 10/1FB      | 35 °       | 841              | 4000 K            | 80              | 660 lm              | 1800 cd            |
| 533513     | 8.5MR16/LED/827/F25/DIM 12V 10/1FB      | 25 °       | 827              | 2700 K            | 80              | 600 lm              | 3100 cd            |
| 533174     | 8.5MR16/LED/830/F25/DIM 12V 10/1FB      | 25 °       | 830              | 3000 K            | 80              | 620 lm              | 3250 cd            |
| 533521     | 8.5MR16/LED/840/F25/DIM 12V 10/1FB      | 25 °       | 841              | 4000 K            | 80              | 660 lm              | 3350 cd            |

### Temperature

| Order Code | Full Product Name                       | T-Case Maximum (Nom) | Order Code | Full Product Name                  | T-Case Maximum (Nom) |
|------------|---|----------------------|------------|------------------------------------|----------------------|
| 454538     | 6.5MR16/F25/2700-2200 DIM 12V 10/1      | -                    | 533141     | 7.3MR16/LED/827/F35/DIM 12V 10/1FB | 90 °C                |
| 454546     | 6.5MR16/F35/2700-2200 DIM 12V 10/1      | -                    | 533158     | 7.3MR16/LED/830/F35/DIM 12V 10/1FB | 90 °C                |
| 470336     | 6.4MR16/F25/3000 DIM 12V 10/1           | 100 °C               | 533182     | 8.5MR16/LED/827/F35/DIM 12V 10/1FB | 100 °C               |
| 470344     | 6.4MR16/F35/3000 DIM 12V 10/1           | 100 °C               | 533190     | 8.5MR16/LED/830/F35/DIM 12V 10/1FB | 100 °C               |
| 470229     | 7MR16 ExpertColor Retail S10 930 10/1   | 90 °C                | 533331     | 8.5MR16/LED/840/F35/DIM 12V 10/1FB | 100 °C               |
| 479139     | 6.5MR16/LED/F25/927/D/EC/12V T20 10/1FB | 92 °C                | 533513     | 8.5MR16/LED/827/F25/DIM 12V 10/1FB | 100 °C               |
| 479147     | 6.5MR16/LED/F25/930/D/EC/12V T20 10/1FB | 92 °C                | 533174     | 8.5MR16/LED/830/F25/DIM 12V 10/1FB | 100 °C               |
| 479162     | 6.5MR16/LED/F35/927/D/EC/12V T20 10/1FB | 92 °C                | 533521     | 8.5MR16/LED/840/F25/DIM 12V 10/1FB | 100 °C               |
| 479170     | 6.5MR16/LED/F35/930/D/EC/12V T20 10/1FB | 92 °C                |            |                                    |                      |
| 470138     | 7.8MR16/PER/927/S10/Dim/EC/12V 10/1FB   | 105 °C               |            |                                    |                      |
| 470146     | 7.8MR16/PER/930/S10/Dim/EC/12V 10/1FB   | 105 °C               |            |                                    |                      |
| 470153     | 7.8MR16/PER/940/S10/Dim/EC/12V 10/1FB   | 105 °C               |            |                                    |                      |
| 470161     | 7.8MR16/PER/927/F25/Dim/EC/12V 10/1FB   | 105 °C               |            |                                    |                      |
| 470179     | 7.8MR16/PER/930/F25/Dim/EC/12V 10/1FB   | 105 °C               |            |                                    |                      |
| 470187     | 7.8MR16/PER/940/F25/Dim/EC/12V 10/1FB   | 105 °C               |            |                                    |                      |
| 470195     | 7.8MR16/PER/927/F35/Dim/EC/12V 10/1FB   | 105 °C               |            |                                    |                      |
| 470203     | 7.8MR16/PER/930/F35/Dim/EC/12V 10/1FB   | 105 °C               |            |                                    |                      |
| 470211     | 7.8MR16/PER/940/F35/Dim/EC/12V 10/1FB   | 105 °C               |            |                                    |                      |
| 470245     | 7MR16 ExpertColor Retail F35 930 10/1   | 90 °C                |            |                                    |                      |
| 533117     | 7.3MR16/LED/827/F25/DIM 12V 10/1FB      | 90 °C                |            |                                    |                      |
| 533125     | 7.3MR16/LED/830/F25/DIM 12V 10/1FB      | 90 °C                |            |                                    |                      |

# LED MR16

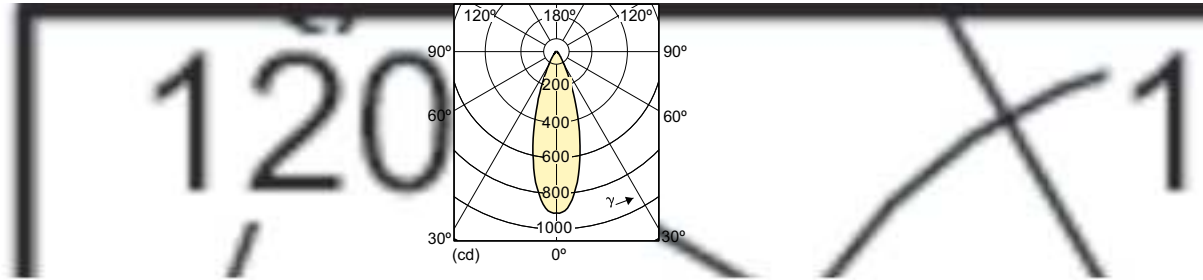

120  
/

120  
/



# LED MR16

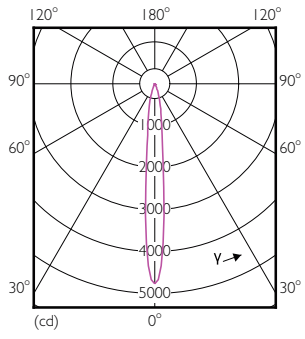

# LED MR16

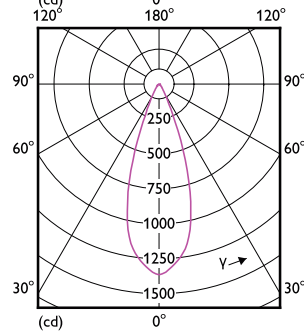
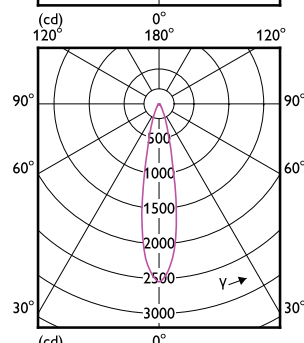
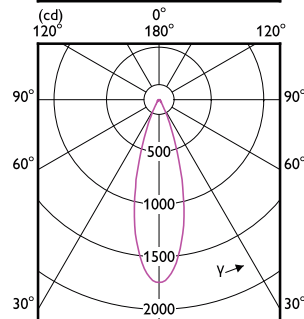
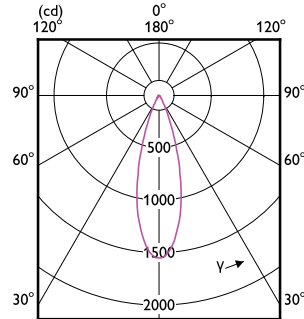
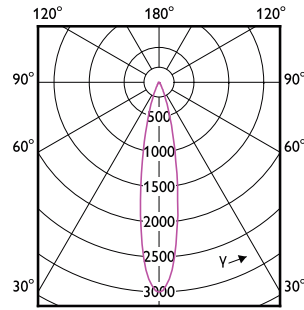
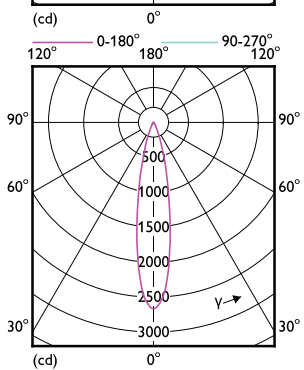
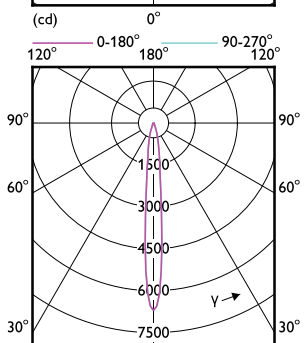
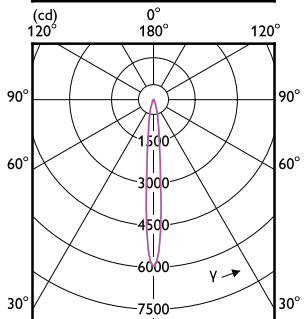
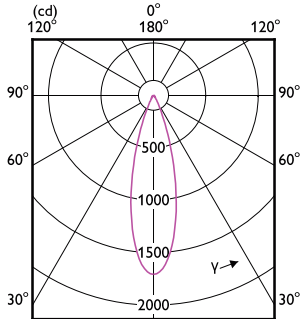
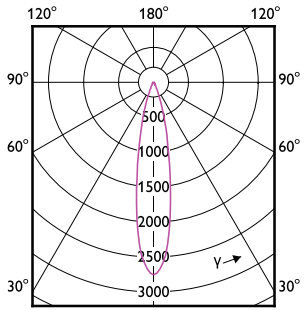

# LED MR16

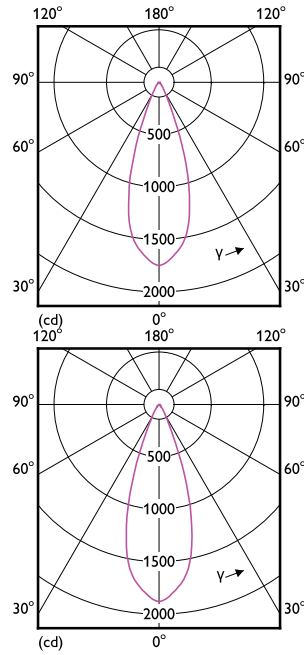
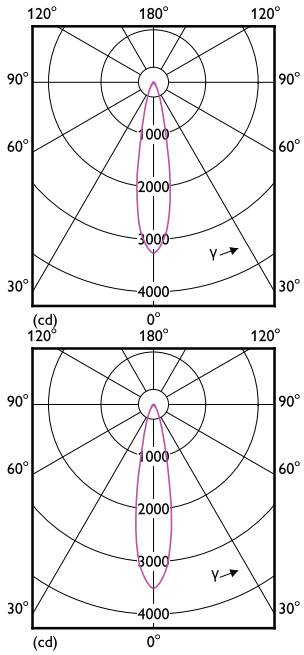

## Accent Diagrams

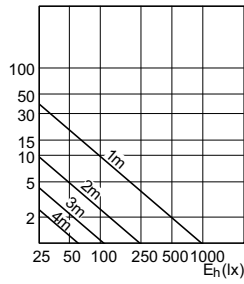
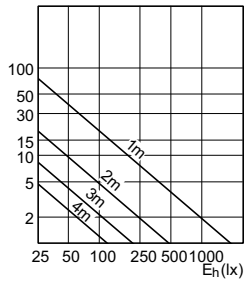

SDAC\_LEDspotL\_0109-Accent diagram



# LED MR16

## Accent Diagrams

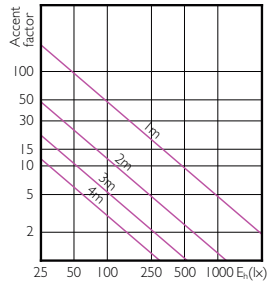

LEDSpots MR16 7W 930 430lm 10D

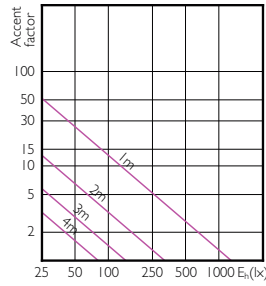

LEDSpots MR16 7W 930 430lm 35D

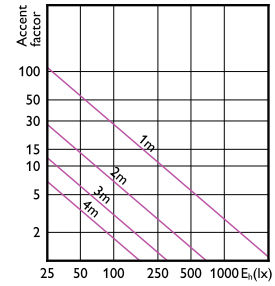

LEDspot 6.5W GU5.3 MR16 927 25D DIM

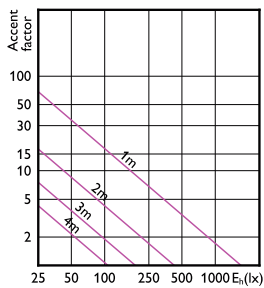

LEDspot 6.5W GU5.3 MR16 927 35D DIM

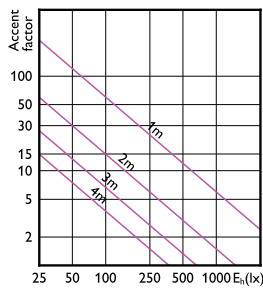

LEDspot 7.8W GU5.3 MR16 927 10D DIM



LEDspot 7.8W GU5.3 MR16 940 10D DIM

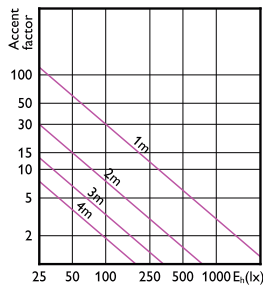

LEDspot 7.8W GU5.3 MR16 940 25D DIM

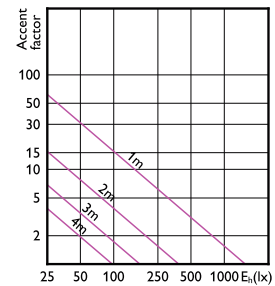

LEDspot 7.8W GU5.3 MR16 927 35D DIM

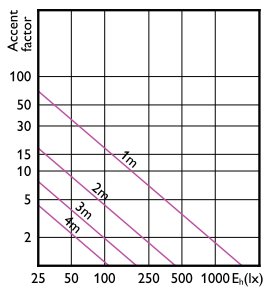

LEDspot 7.8W GU5.3 MR16 940 35D DIM

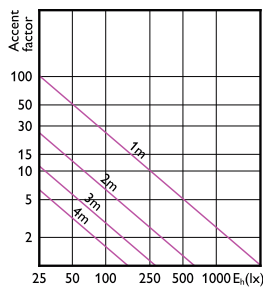

LEDspot 7.3W GU5.3 MR16 827 25D DIM

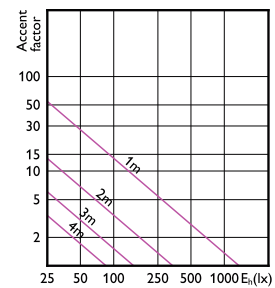

LEDspot 7.3W GU5.3 MR16 827 35D DIM

# LED MR16

## Accent Diagrams

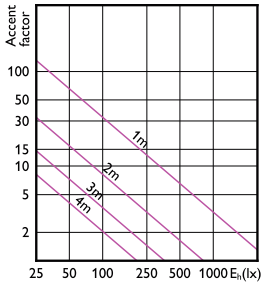

8-50W GU5-3 MR16 24D 827 2700K

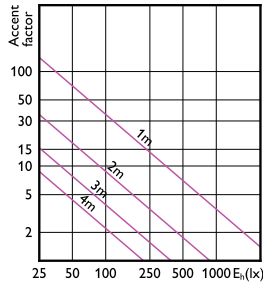

LEDspot MAS 8-50W GU5,3 MR16 840 24D DIM

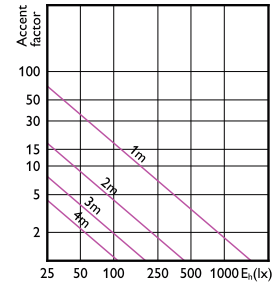

8-50W GU5-3 MR16 36D 827 2700K

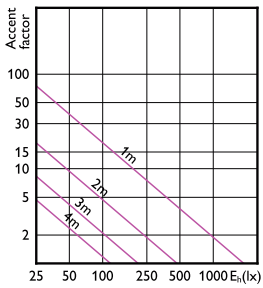

8-50W GU5-3 MR16 36D 840 4000K

## Beam Diagrams

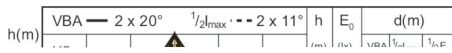

SDBE\_LEDspotL\_0108-Beam diagram



SDBE\_LEDspotL\_0109-Beam diagram

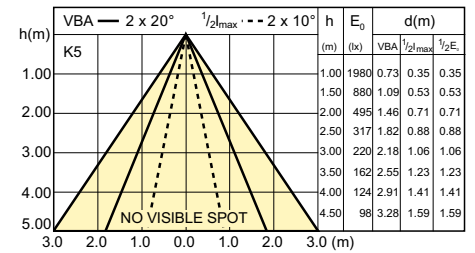

SDBE\_LEDspotL\_0127-Beam diagram

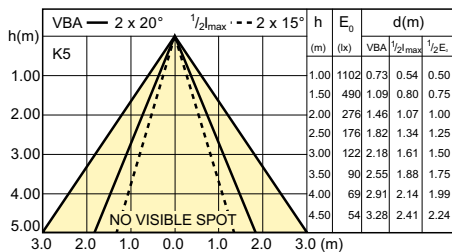

SDBE\_LEDspotL\_0130-Beam diagram

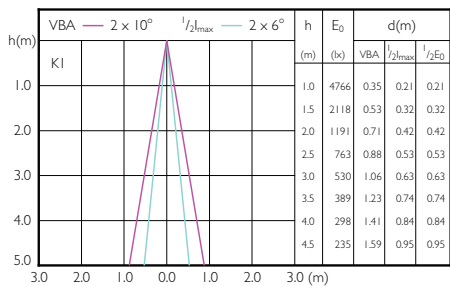

LEDspots MR16 7W 930 430lm 10D

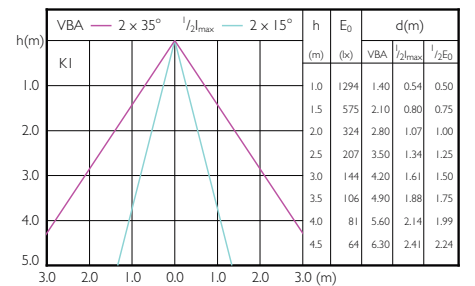

LEDspots MR16 7W 930 430lm 35D

# LED MR16

## Beam Diagrams

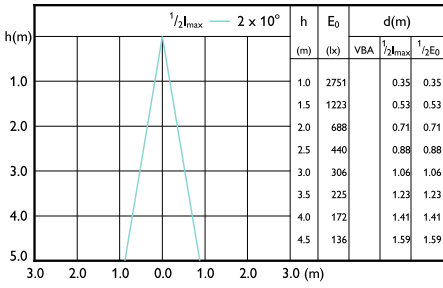

LEDspot 6.5W GU5.3 MR16 927 25D DIM

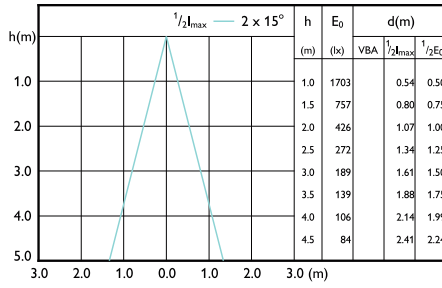

LEDspot 6.5W GU5.3 MR16 927 35D DIM

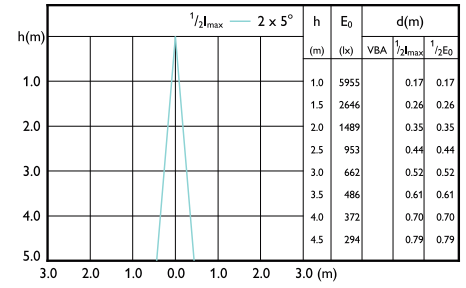

LEDspot 7.8W GU5.3 MR16 927 10D DIM

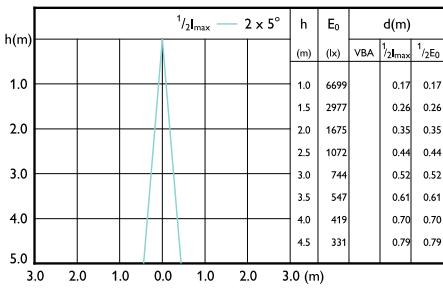

LEDspot 7.8W GU5.3 MR16 940 10D DIM

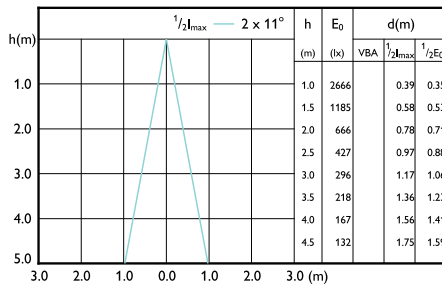

LEDspot 7.8W GU5.3 MR16 927 25D DIM

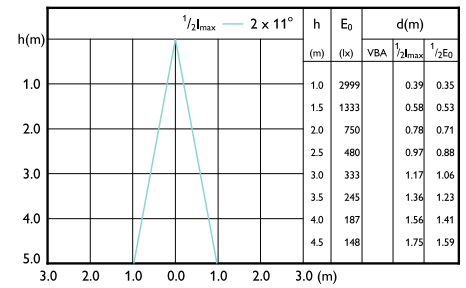

LEDspot 7.8W GU5.3 MR16 940 25D DIM

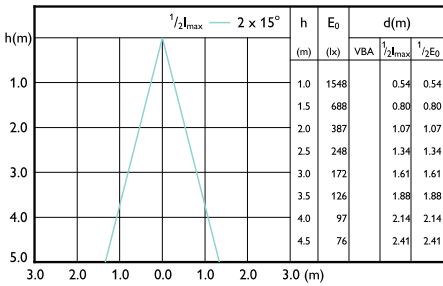

LEDspot 7.8W GU5.3 MR16 927 35D DIM

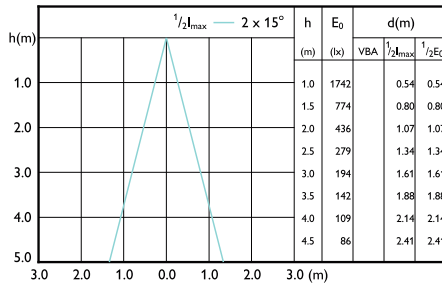

LEDspot 7.8W GU5.3 MR16 940 35D DIM

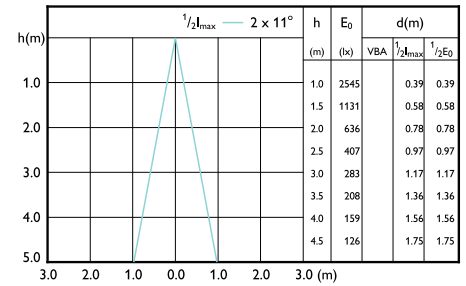

LEDspot 7.3W GU5.3 MR16 827 25D DIM

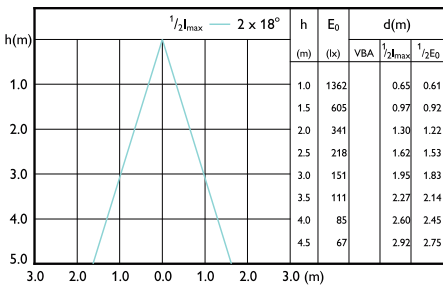

LEDspot 7.3W GU5.3 MR16 827 35D DIM

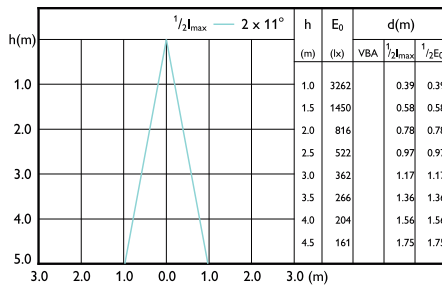

8-50W GU5-3 MR16 24D 827 2700K

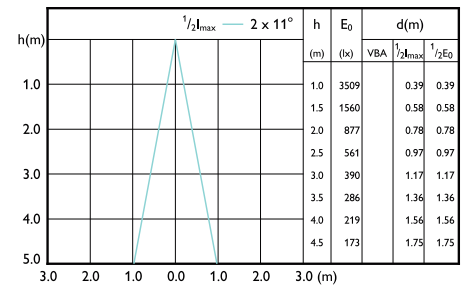

LEDspot MAS 8-50W GU5.3 MR16 840 24D DIM

# LED MR16

## Beam Diagrams

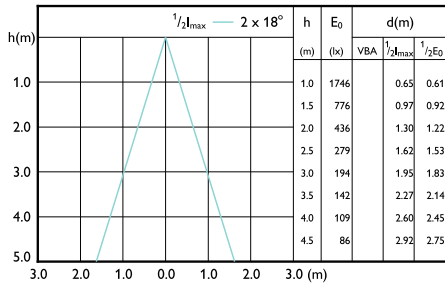

8-50W GU5-3 MR16 36D 827 2700K

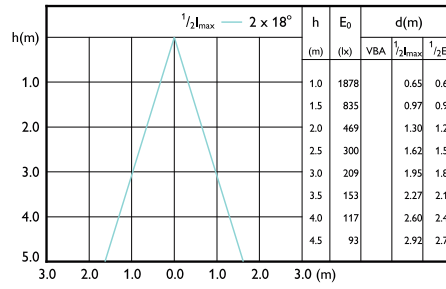

8-50W GU5-3 MR16 36D 840 4000K

