



Lightolier LyteCaster LED Downlights are ideal general purpose downlighting solution, providing comfortable, quality light. Available in new construction and remodeler frame with interchangeable light engine that is offered in two lumen packages. The downlight is wet location listed and comes in 3 standard option.

Project: _____
 Location: _____
 Cat.No: _____
 Type: _____
 Lamps: _____ Qty: _____
 Notes: _____

Complete product = Frame-in kit + Light engine + Trim (order each separately)

Frame-In kit

Example: L6RAE1VA

Series	Lumens ¹	Frame type	Dimming	Input voltage	Version
L6R					VA
L6R LyteCaster 6" Round	blank 1500 20 2000	A AirSeal IC, New Construction, Screw AN AirSeal IC, New Construction, Nail	E ELV dimming Z10 0-10V	1 120V U Universal	VA Version A ²
	15 1500 20 2000	R AirSeal IC, Remodeler			

Light engine

Example: L6R15827VA

Series	Lumens ¹	CRI	CCT	Version
L6R				VA
L6R LyteCaster 6" Round	15 1500 20 2000	8 80	27 2700K 30 3000K 35 3500K 40 4000K	VA Version A ²
			9 90	

Trim

Example: L6RDW

Series	Luminaire type	Finish
L6R		
L6R LyteCaster 6" Round	D Open Downlight	D Clear diffuse (with white flange) W White (with white flange)
	B Baffle Downlight	W White (with white flange)



Open Downlight (white)

Baffle Downlight (white)

Open Downlight (clear diffuse)

1. When ordering a Frame-in kit and a Light engine, the lumen package code must match.
 2. Version A (VA) frames and light engines are not compatible with previous versions.

Note: Lumen output is calculated based on 80 CRI and 3500K CCT. Please consult adjustment factors table on page 5 for other lumen outputs.

Light to go

Compatible configurations

Frames	Engines	Trims
L6RAE1VA L6RANE1VA L6RANZ10UVA L6RAZ10UVA	L6R15827VA L6R15830VA L6R15927VA	L6RDD L6RDW L6RBW



L6R LyteCaster LED 6"

Round Downlight

New construction frame-in kit

Bottom view

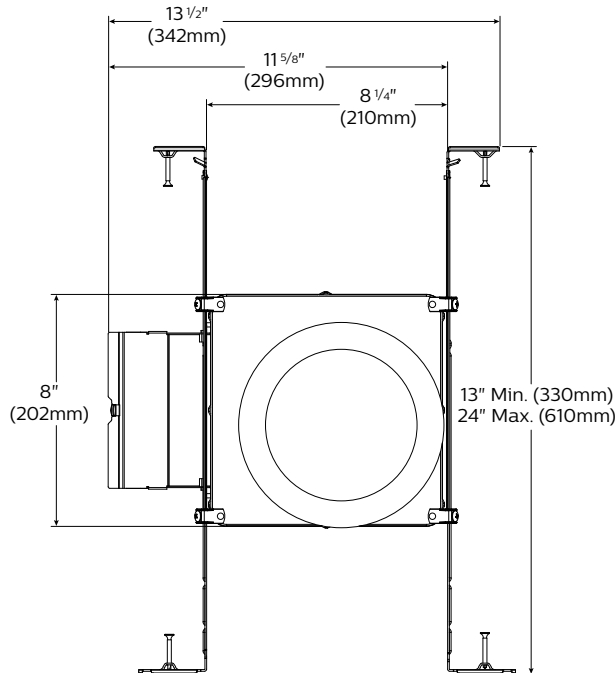

Side view

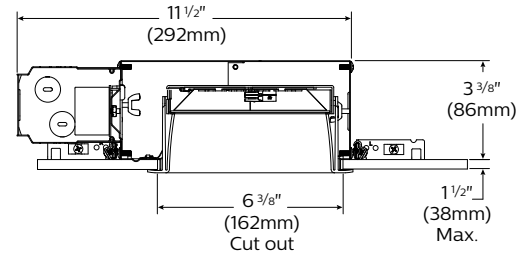

Downlight trim

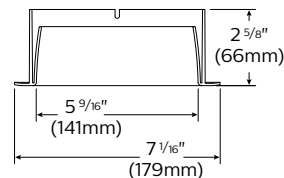

Light engine

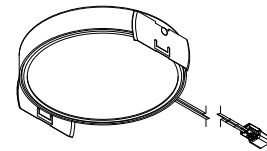

Features

- Housing:** .026" galvanized steel. UL listed for direct contact with thermal insulation. Airseal® housing minimizes air leakage to less than 2 CFM at 1.57PSF (or 75PA), which complies with the International Energy Conservation Code, and Washington State Energy Code (Section 502.4). This reduces heat loss and condensation in ceiling. Access door for inspection of junction box.
- Lower frame and top cover:** .026" galvanized steel. Accommodates ceilings up to 1 1/2" (38mm) thick. 3/8" (9.5mm) deep integral lip with four notches at 90° apart to simplify alignment. Locks into position along length of mounting bars with locking screws.
- Junction Box:** 2.5" X 5 3/8" X 2" (27 cu. in) .032" galvanized steel. UL listed 90° supply conductors. Rated for branch circuit wiring supplying connected luminaires (daisy chaining).
- Retaining clips:** Permit easy and fast installation of light engine/trim.
- Mounting bars:** .059" galvanized steel. Bars pivot for easy attachment and wire-in below ceiling line. Bars extend to accommodate 16" (406mm) to 24" (610mm) O.C. joist spacing. Bars can accommodate 12" (305mm) O.C. joist spacing after a slight field modification (see Instruction sheet). Features integral self tapping phillips/square drive screws for secure attachment to wood or metal construction. Also available with integral nails. Attaches to T-bar ceilings without the need of accessories. Bars installed on shortest dimension of frame, but can be easily repositioned 90 degrees from original position.
- Driver: ELV:** 120V, 50/60Hz. RoHS compliant, Class 2 power supply. Complies with FCC rules per Title 47 Part 15 (Class B) for EMI / RFI (conducted & radiated). Class A sound rating.
0-10V: 120/277V, 50/60Hz. RoHS compliant, Class 2 power supply. Complies with FCC rules per Title 47 Part 15 (Class A) for EMI / RFI (conducted & radiated). Class A sound rating.
- Ceiling cutout:** 6 3/8" (162mm).

Electrical

Lifetime: Expected lifetime 50,000 hours and backed by a 5-year warranty. (see Philips.com/warranties for details)

Recommended dimmers

See LED-DIM Specification Sheet.

Labels

cULus Listed Type I.C. frames are suitable for damp location. Trims are cULus suitable for wet location (no shower lens unit required). Complies with Air Leakage. Energy Star certified.

L6R LyteCaster LED 6"

Round Downlight

Remodeler kit

Bottom view

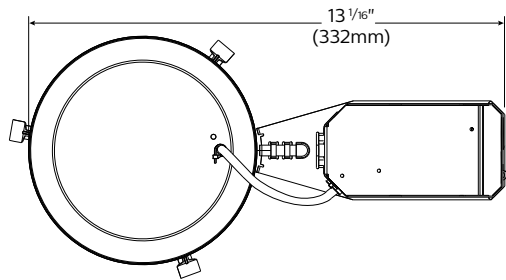

Side view

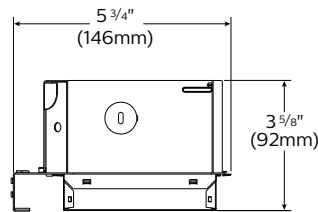

Side view

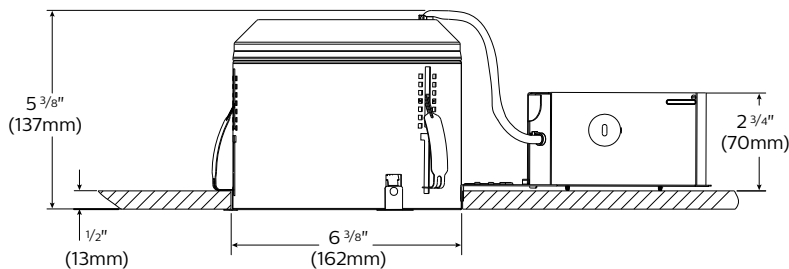

Features

- Housing:** .032 Aluminum. UL listed for direct contact with thermal insulation. Integral retaining spring secures housing to ceilings up to 2" thick. Removable for access to junction box and ceiling plenum. 5 1/2" maximum for use in 2" x 6" joist construction and shallow plenum applications. Airseal® housing minimizes air leakage to less than 2 CFM at 1.57PSF (or 75PA), which complies with the International Energy Conservation Code, and Washington State Energy Code (Section 502.4). This reduces heat loss and condensation in ceiling.
- Junction Box:** 2 1/2" x 2 1/2" x 4 7/8" (29 cu in.). .031" galvanized steel. UL listed for 90°C supply conductors. Rated for branch circuit wiring supplying connected fixtures.
- Retaining clips:** Permit easy and fast installation of light engine/trim.
- Driver: ELV / Triac:** 120V, 50/60Hz. RoHS compliant, Class 2 power supply. Complies with FCC rules per Title 47 Part 15 (Class B) for EMI / RFI (conducted & radiated). Class A sound rating.
0-10V: 120/277V, 50/60Hz. RoHS compliant, Class 2 power supply. Complies with FCC rules per Title 47 Part 15 (Class A) for EMI / RFI (conducted & radiated). Class A sound rating.
- Ceiling cutout:** 6 3/8" (162mm).

Electrical

Lifetime: Expected lifetime 50,000 hours and backed by a 5-year warranty. (see Philips.com/warranties for details)

Recommended dimmers

See LED-DIM Specification Sheet.

Labels

cULus Listed Type I.C., frames are suitable for damp location. Trims are cULus suitable for wet location (no shower lens unit required). Complies with Air Leakage. Energy Star certified.

L6R LyteCaster LED 6"

Round Downlight

Reflector: Round downlight

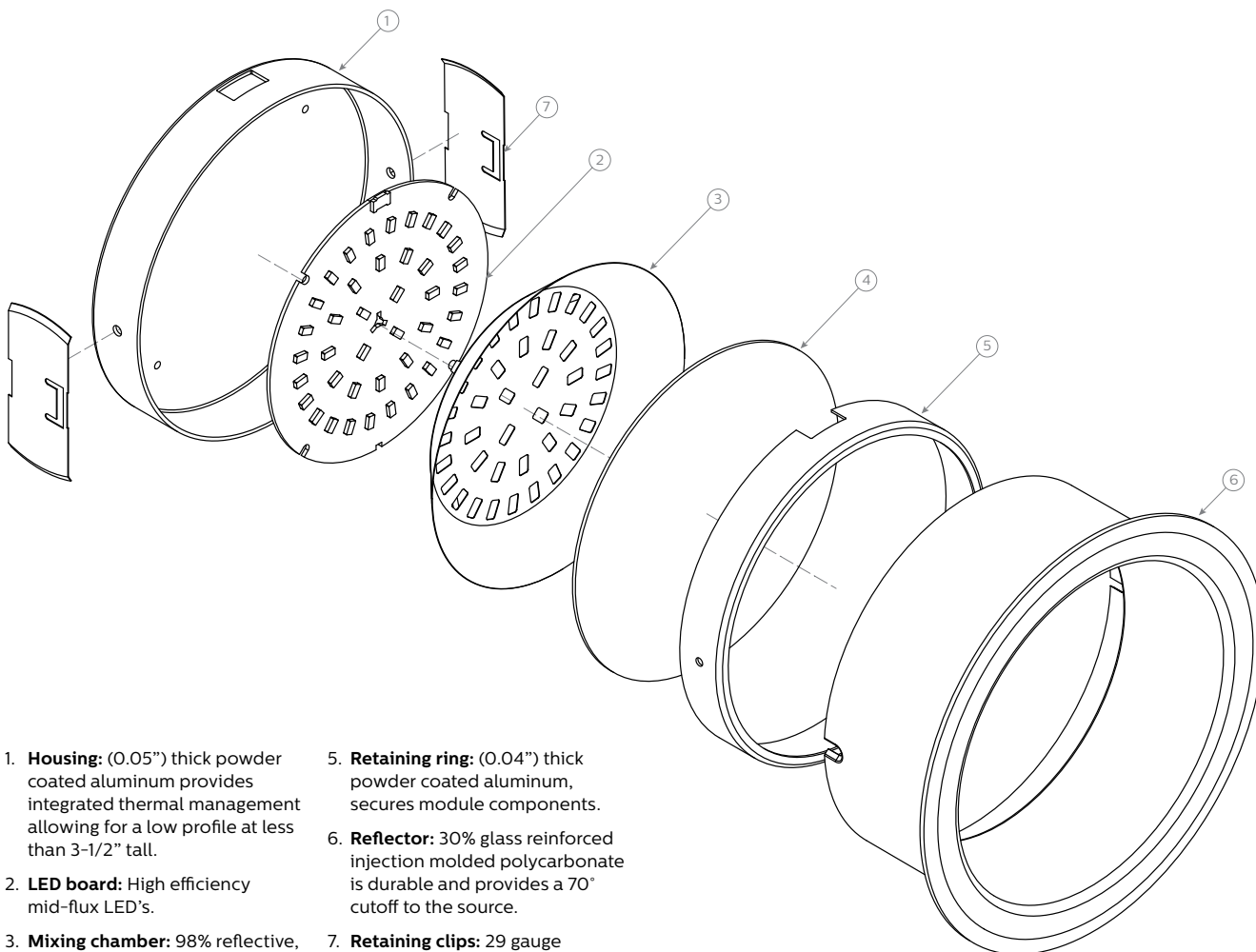

1. **Housing:** (0.05") thick powder coated aluminum provides integrated thermal management allowing for a low profile at less than 3-1/2" tall.
2. **LED board:** High efficiency mid-flux LED's.
3. **Mixing chamber:** 98% reflective, highly diffuse film.
4. **Diffusion lens:** (0.06") thick acrylic opal lens provides an even source of illumination.
5. **Retaining ring:** (0.04") thick powder coated aluminum, secures module components.
6. **Reflector:** 30% glass reinforced injection molded polycarbonate is durable and provides a 70° cutoff to the source.
7. **Retaining clips:** 29 gauge Stainless Steel, allows tool-less installation of light engine to trim.

Electrical specifications

Frame-in kit / Remodeler

	Lumens	Input volts	Input freq.	Input current	LED drive current	Input power	LED power	THD factor	Power factor
L6RAE1VA / L6R15RE1VA	1500	120V	50/60Hz	0.14A	350mA	16W	13W	<20%	>0.9
L6RAZ10UVA / L6R15RZ10UVA	1500	120V	50/60Hz	0.14A	350mA	17W	13W	<10%	>0.9
		277V	50/60Hz	0.07A	350mA	17W	15W	<15%	>0.9
L6R20AE1VA / L6R20RE1VA	2000	120V	50/60Hz	0.175A	470mA	19W	16W	<20%	>0.9
L6R20AZ10UVA / L6R20R10UVA	2000	120V	50/60Hz	0.26A	470mA	20W	16W	<10%	>0.95
		277V	50/60Hz	0.11A	470mA	20W	16W	<15%	>0.95

L6R LyteCaster LED 6"

Round Downlight

80 CRI, 1500 lumens

Candela Curves	Angle	Mean CP	Lumens
	0	730	
	5	724	69
	10	412	
	15	698	197
	20	671	
	25	634	292
	30	596	
	35	538	336
	40	473	
	45	397	304
	50	314	
	55	235	210
	60	161	
	65	107	111
	70	80	
	75	59	62
	80	37	
	85	16	18
	90	0	

Single unit data		
Height to Lighted Plane	Initial Center Beam Foot-Candles	Beam Dia. (ft)*
5'	29	6.0'
6'	20	7.2'
7'	15	8.4'
8'	11	9.6'
9'	9	10.8'

* Beam diameter is where foot-candles drop to 50% of maximum.

Multiple unit data - RCR 2		
Spacing on center	Initial Center Beam Foot-Candles	Watts per Sq. Ft.
5'	66.8	0.71
6'	43.8	0.47
7'	31.3	0.33
8'	26.1	0.28
9'	20.9	0.22

Coefficients of utilization												
Ceiling	80%				70%		50%		30%		0%	
Wall	70	50	30	10	50	10	50	10	50	10	0	
RCR	Zonal cavity method - Effective floor reflectance = 20%											
Room Cavity Ratio	0	119	119	119	119	116	116	111	111	106	106	100
	1	110	106	102	99	104	97	100	94	96	92	87
	2	102	94	88	83	92	82	89	80	86	79	75
	3	94	84	77	71	83	71	80	69	77	68	65
	4	86	76	68	62	74	61	72	60	70	60	57
	5	80	68	60	54	67	54	65	53	63	53	50
	6	74	62	54	48	61	48	59	47	58	47	45
	7	69	57	48	43	56	43	54	42	53	42	40
	8	65	52	44	38	51	38	50	38	49	38	36
	9	60	48	40	35	47	35	46	35	45	34	33
	10	57	44	37	32	44	32	43	32	42	31	30

Frame: L6RAE1VA / L6RAZ10UVA / L6R15RE1VA / L6R15RZ10UVA
 Light engine: L6R15835VA
 Trim: L6RDW
 Report no³: 686GFR
 Output lumens: 1599lm
 Input Watts: 16W
 Spacing Criterion: 1.2
 Efficacy: 99.9lm/W
 CCT²: 3500K
 CRI: ≥80

38'x38'x10' Room, Workplane 2.5' above floor, 80/50/20% Reflectances

Zonal lumens & percentages			CRI and CCT adjustment factors	
Zone	Lumens	%Luminaire		
0-30	5558	34.6%	90CRI 2700K: = 0.71	
0-40	893	55.9%	80CRI 2700K: = 0.89	
0-60	1408	88.1%	80CRI 3000K: = 0.97	
0-90	1599	100.0%	80CRI 3500K: = 1.00	

80 CRI, 2000 lumens

Candela Curves	Angle	Mean CP	Lumens
	0	863	
	5	856	81
	10	843	
	15	818	230
	20	778	
	25	730	336
	30	671	
	35	604	377
	40	529	
	45	448	345
	50	365	
	55	284	254
	60	205	
	65	137	141
	70	98	
	75	70	74
	80	43	
	85	19	22
	90	0	

Single unit data		
Height to Lighted Plane	Initial Center Beam Foot-Candles	Beam Dia. (ft)*
5'	35	5.5'
6'	24	6.6'
7'	18	7.7'
8'	13	8.8'
9'	11	9.9'

* Beam diameter is where foot-candles drop to 50% of maximum.

Multiple unit data - RCR 2		
Spacing on center	Initial Center Beam Foot-Candles	Watts per Sq. Ft.
5'	77.5	0.88
6'	50.8	0.58
7'	36.3	0.41
8'	30.3	0.34
9'	24.2	0.27

Coefficients of utilization												
Ceiling	80%				70%		50%		30%		0%	
Wall	70	50	30	10	50	10	50	10	50	10	0	
RCR	Zonal cavity method - Effective floor reflectance = 20%											
Room Cavity Ratio	0	119	119	119	119	116	116	111	111	106	106	100
	1	110	106	102	99	104	97	100	94	96	91	87
	2	101	94	88	83	92	82	89	80	86	78	75
	3	93	84	77	71	82	70	79	69	77	68	65
	4	86	75	67	61	74	61	72	60	69	59	56
	5	80	68	60	54	67	53	65	53	63	52	50
	6	74	62	53	47	61	47	59	47	57	46	44
	7	69	56	48	42	55	42	54	42	53	42	39
	8	64	52	44	38	51	38	50	38	48	38	36
	9	60	48	40	35	47	35	46	34	45	34	32
	10	57	44	37	32	44	32	43	31	42	31	29

Frame: L6R20AZ20UVA / L6R20AE1VA / L6R20RZ10UVA / L6R20RE1VA
 Light engine: L6R20835VA
 Trim: L6RDW
 Report no³: 891GFR
 Output lumens: 1859lm
 Input Watts: 19.8W
 Spacing Criterion: 1.1
 Efficacy: 93.9lm/W
 CCT²: 3500K
 CRI: ≥80

38'x38'x10' Room, Workplane 2.5' above floor, 80/50/20% Reflectances

Zonal lumens & percentages			CRI and CCT adjustment factors	
Zone	Lumens	%Luminaire		
0-30	647	34.8%	90CRI 2700K: = 0.71	
0-40	1023	55.1%	80CRI 2700K: = 0.89	
0-60	1622	87.3%	80CRI 3000K: = 0.97	
0-90	1859	100.0%	80CRI 3500K: = 1.00	

1. Wattage: controlled to within ± 5%
2. Correlated Color Temperature: within specs as defined in ANSI_NEMA_ANSI C78.377-2008: Specifications for the Chromaticity of Solid State Lighting Products.
3. Tested using absolute photometry as specified in LM79: IESNA Approved Method for the Electrical and Photometric Measurements of Solid-State Lighting Products.

The information presented in this document is not intended as any commercial offer and does not form part of any quotation or contract.

