



Elegance meets efficiency

MASTER LEDbulbs

The MASTER LEDbulb range delivers a dimmable glow effect for a welcoming, warm atmosphere, making it ideal for general lighting applications in the hospitality industry. Its unique design radiates warm light in all directions, making it a true alternative to incandescent lamps. They are particularly suitable for public areas such as lobbies, corridors, stairwells, where the light is always on. Compatible with existing fixtures with an E27 holder and designed for retrofit replacement of incandescent bulbs, MASTER LEDbulb delivers huge energy savings and minimizes maintenance cost without any compromise on light quality. They can be used together with most leading-edge dimmers, enabling further efficiencies while helping to create the desired atmosphere.

Benefits

- Easy (retrofit) replacement ideal for general lighting applications
- Unique design and light effect that mimics the light quality of incandescent lamps
- Up to 80% energy saving compared with traditional incandescent lamps

Features

- The gradual dimming feature enables light levels to dim to warm tones of traditional lamps
- Dimmable range that is compatible with an extensive range of dimmers
- Lifetime of 25,000 hours
- High CRI (CRI 90)
- UV- and IR-free light

Application

- Hotels, restaurants, bars, cafés
- Lobbies, corridors, stairwells, reception areas

MASTER LEDbulbs

Warnings and Safety

- Operating temperature range is between -20° C and 45° C ambient
- Only to apply in dry or damp locations and most of open fixtures with lamp-holders that offer sufficient space (10 mm free air space)
- Not intended for use with emergency light fixtures or exit lights

Versions



B22 A60 CL



B22 A60 Clear



E27 A60 CL



E27 A60 Clear



E27 A67



B22 A67



E27 A60 FR



E27 A60 FR

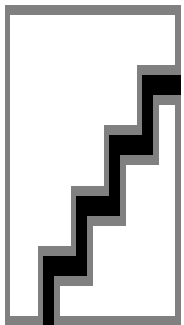

LED Bulb E27 A67 Frosted

MASTER LEDbulbs

Dimensional drawing

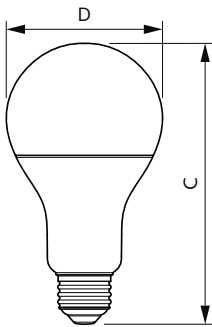
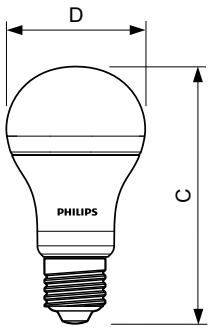
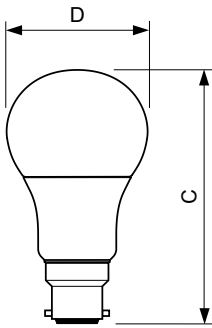
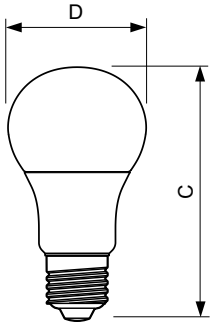

Product	D	C
MAS LEDbulb DT 15-100W A67 E27 827 FR	70.6 mm	137.2 mm
MAS LED bulb DT 5.5-40WE27 927-922 A60FR	60 mm	110 mm
MAS LEDbulb DT 11-75W A67 E27 827 FR	70.6 mm	137.2 mm
MASTER LEDbulb DT 8.5-60W E27 A60 CL	60 mm	110 mm

Product	D	C
MAS LEDbulb DT 11-75W A67 B22 827 FR	70.6 mm	135.9 mm
MAS LEDbulb DT 15-100W A67 B22 827 FR	70.6 mm	135.9 mm
MASTER LEDbulb DT 8.5-60W B22 A60 CL	60 mm	110 mm

Product	D	C
MASTER LED bulb DT 9-60W E27 927-922 A60 FR	60 mm	110 mm

Product	D	C
MASTERLEDbulb DT 14-100WE27 927-922 A67FR	77 mm	142 mm

MASTER LEDbulbs

Dimensional drawing

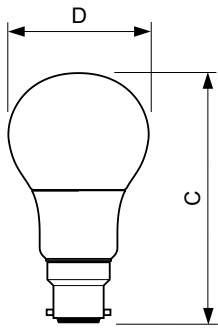
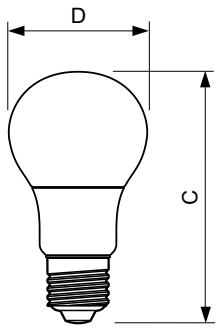
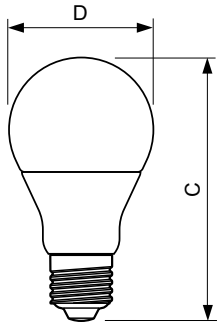

Product	D	C
MASTER LED bulb DT 12-75WE27 927-922 A67 FR	77 mm	142 mm
MASTERLEDbulb DT 15-100WE27 927-922 A67FR	77 mm	142 mm

Product
MASTER LEDbulb DT 6-40W E27 A60 CL

Product	D	C
MAS LEDbulb DT 6-40W B22 A60 CL	60 mm	110 mm

MASTER LEDbulbs

Approval and Application	
Energy Efficiency Label (EEL)	A+
Controls and Dimming	
Dimmable	Yes
Operating and Electrical	
Voltage (Nom)	220-240 V
General Information	
Nominal Lifetime (Nom)	25000 h
Rated Lifetime (Hours)	25000 h
Light Technical	
Correlated Color Temperature (Nom)	2200-2700 K
Llmf At End Of Nominal Lifetime (Nom)	70 %

Approval and Application

Order Code	Full Product Name	Energy Consumption kWh/1000 h
929001150602	MASTER LEDbulb DT 6-40W B22 A60 CL	6 kWh
929001150732	MASTER LEDbulb DT 8.5-60W B22 A60 CL	9 kWh
929001150802	MASTER LEDbulb DT 6-40W E27 A60 CL	6 kWh
929001150932	MASTER LEDbulb DT 8.5-60W E27 A60 CL	9 kWh
929001184402	MASTER LEDbulb DT 15-100W A67 E27 827 FR	15 kWh
929001200502	MASTER LEDbulb DT 11-75W A67 E27 827 FR	11 kWh
929001200302	MASTER LEDbulb DT 15-100W A67 B22 827 FR	15 kWh
929001200402	MASTER LEDbulb DT 11-75W A67 B22 827 FR	11 kWh
929001351302	MASTER LED bulb DT 5.5-40WE27 927-922 A60FR	6 kWh

Order Code	Full Product Name	Energy Consumption kWh/1000 h
929001351402	MASTER LED bulb DT 9-60W E27 927-922 A60 FR	9 kWh
929001868602	MASTER LED bulb DT 12-75WE27 927-922 A67 FR	12 kWh
929001868702	MASTERLEDbulb DT 15-100WE27 927-922 A67FR	15 kWh
929002218602	MASTERLEDbulb DT 14-100WE27 927-922 A67FR	14 kWh

Operating and Electrical

Order Code	Full Product Name	Input Frequency	Wattage Equivalent	Power	Starting
				(Rated) (Nom)	Time (Nom)
929001150602	MASTER LEDbulb DT 6-40W B22 A60 CL	50 to 60 Hz	40 W	6 W	0.5 s
929001150732	MASTER LEDbulb DT 8.5-60W B22 A60 CL	50 to 60 Hz	60 W	8.5 W	0.5 s
929001150802	MASTER LEDbulb DT 6-40W E27 A60 CL	50 to 60 Hz	40 W	6 W	0.5 s
929001150932	MASTER LEDbulb DT 8.5-60W E27 A60 CL	50 to 60 Hz	60 W	8.5 W	0.5 s
929001184402	MASTER LEDbulb DT 15-100W A67 E27 827 FR	50 to 60 Hz	100 W	15 W	0.5 s
929001200502	MASTER LEDbulb DT 11-75W A67 E27 827 FR	50 to 60 Hz	75 W	11 W	0.5 s

Order Code	Full Product Name	Input Frequency	Wattage Equivalent	Power	Starting
				(Rated) (Nom)	Time (Nom)
929001200302	MASTER LEDbulb DT 15-100W A67 B22 827 FR	50 to 60 Hz	100 W	15 W	0.5 s
929001200402	MASTER LEDbulb DT 11-75W A67 B22 827 FR	50 to 60 Hz	75 W	11 W	0.5 s
929001351302	MASTER LED bulb DT 5.5-40WE27 927-922 A60FR	50 to 60 Hz	40 W	5.5 W	0.3 s
929001351402	MASTER LED bulb DT 9-60W E27 927-922 A60 FR	50 to 60 Hz	60 W	9 W	0.3 s

MASTER LEDbulbs

Order Code	Full Product Name	Input Frequency	Wattage Equivalent	Power (Rated) (Nom)	Starting Time (Nom)
929001868602	MASTER LED bulb DT 12-75WE27 927-922 A67 FR	50 to 60 Hz	75 W	12 W	0.1 s
929001868702	MASTERLEDbulb DT 15-100WE27 927-922 A67FR	-	100 W	15 W	0.1 s

Order Code	Full Product Name	Input Frequency	Wattage Equivalent	Power (Rated) (Nom)	Starting Time (Nom)
929002218602	MASTERLEDbulb DT 14-100WE27 927-922 A67FR	50 to 60 Hz	100 W	14 W	0.5 s

General Information

Order Code	Full Product Name	Cap-Base	Switching Cycle
929001150602	MASTER LEDbulb DT 6-40W B22 A60 CL	B22	50000X
929001150732	MASTER LEDbulb DT 8.5-60W B22 A60 CL	B22	50000X
929001150802	MASTER LEDbulb DT 6-40W E27 A60 CL	E27	50000X
929001150932	MASTER LEDbulb DT 8.5-60W E27 A60 CL	E27	50000X
929001184402	MASTER LEDbulb DT 15-100W A67 E27 827 FR	E27	50000X
929001200502	MASTER LEDbulb DT 11-75W A67 E27 827 FR	E27	50000X
929001200302	MASTER LEDbulb DT 15-100W A67 B22 827 FR	B22	50000X
929001200402	MASTER LEDbulb DT 11-75W A67 B22 827 FR	B22	50000X

Order Code	Full Product Name	Cap-Base	Switching Cycle
929001351302	MASTER LED bulb DT 5.5-40WE27 927-922 A60FR	E27	100000X
929001351402	MASTER LED bulb DT 9-60W E27 927-922 A60 FR	E27	100000X
929001868602	MASTER LED bulb DT 12-75WE27 927-922 A67 FR	E27	100000X
929001868702	MASTERLEDbulb DT 15-100WE27 927-922 A67FR	E27	100000X
929002218602	MASTERLEDbulb DT 14-100WE27 927-922 A67FR	E27	100000X

Light Technical

Order Code	Full Product Name	Beam Angle (Nom)	Color Rendering Index		Luminous Flux (Nom)	Luminous Flux (Rated) (Nom)
			Color Code	(Nom)		
929001150602	MASTER LEDbulb DT 6-40W B22 A60 CL	-	822-827	80	470 lm	470 lm
929001150732	MASTER LEDbulb DT 8.5-60W B22 A60 CL	-	822-827	80	806 lm	806 lm
929001150802	MASTER LEDbulb DT 6-40W E27 A60 CL	-	822-827	80	470 lm	470 lm
929001150932	MASTER LEDbulb DT 8.5-60W E27 A60 CL	-	822-827	80	806 lm	806 lm
929001184402	MASTER LEDbulb DT 15-100W A67 E27 827 FR	-	822-827	80	1521 lm	1521 lm
929001200502	MASTER LEDbulb DT 11-75W A67 E27 827 FR	-	822-827	80	1055 lm	1055 lm
929001200302	MASTER LEDbulb DT 15-100W A67 B22 827 FR	-	822-827	80	1521 lm	1521 lm
929001200402	MASTER LEDbulb DT 11-75W A67 B22 827 FR	-	822-827	80	1055 lm	1055 lm
929001351302	MASTER LED bulb DT 5.5-40WE27 927-922 A60FR	200 °	922-927	90	470 lm	470 lm
929001351402	MASTER LED bulb DT 9-60W E27 927-922 A60 FR	200 °	922-927	90	806 lm	806 lm
929001868602	MASTER LED bulb DT 12-75WE27 927-922 A67 FR	200 °	922-927	90	1055 lm	1055 lm
929001868702	MASTERLEDbulb DT 15-100WE27 927-922 A67FR	200 °	922-927	90	1521 lm	1521 lm
929002218602	MASTERLEDbulb DT 14-100WE27 927-922 A67FR	200 °	922-927	90	1521 lm	1521 lm

Mechanical and Housing

Order Code	Full Product Name	Bulb Finish	Bulb Shape
929001150602	MASTER LEDbulb DT 6-40W B22 A60 CL	Clear	A60
929001150732	MASTER LEDbulb DT 8.5-60W B22 A60 CL	Clear	A60
929001150802	MASTER LEDbulb DT 6-40W E27 A60 CL	Clear	A60
929001150932	MASTER LEDbulb DT 8.5-60W E27 A60 CL	Clear	A60

Order Code	Full Product Name	Bulb Finish	Bulb Shape
929001184402	MASTER LEDbulb DT 15-100W A67 E27 827 FR	-	A67
929001200502	MASTER LEDbulb DT 11-75W A67 E27 827 FR	-	A67

MASTER LEDbulbs

Order Code	Full Product Name	Bulb Finish	Bulb Shape
929001200302	MASTER LEDbulb DT 15-100W A67 B22 827 FR	-	A67
929001200402	MASTER LEDbulb DT 11-75W A67 B22 827 FR	-	A67
929001351302	MASTER LED bulb DT 5.5-40WE27 927-922 A60FR	Frosted	A60
929001351402	MASTER LED bulb DT 9-60W E27 927-922 A60 FR	Frosted	A60

Order Code	Full Product Name	Bulb Finish	Bulb Shape
929001868602	MASTER LED bulb DT 12-75WE27 927-922 A67 FR	Frosted	A67
929001868702	MASTERLEDbulb DT 15-100WE27 927-922 A67FR	Frosted	A67
929002218602	MASTERLEDbulb DT 14-100WE27 927-922 A67FR	Frosted	A67

Temperature

Order Code	Full Product Name	T-Case Maximum (Nom)
929001150602	MASTER LEDbulb DT 6-40W B22 A60 CL	85 °C
929001150732	MASTER LEDbulb DT 8.5-60W B22 A60 CL	110 °C
929001150802	MASTER LEDbulb DT 6-40W E27 A60 CL	85 °C
929001150932	MASTER LEDbulb DT 8.5-60W E27 A60 CL	110 °C
929001184402	MASTER LEDbulb DT 15-100W A67 E27 827 FR	105 °C
929001200502	MASTER LEDbulb DT 11-75W A67 E27 827 FR	100 °C
929001200302	MASTER LEDbulb DT 15-100W A67 B22 827 FR	105 °C
929001200402	MASTER LEDbulb DT 11-75W A67 B22 827 FR	100 °C
929001351302	MASTER LED bulb DT 5.5-40WE27 927-922 A60FR	70 °C
929001351402	MASTER LED bulb DT 9-60W E27 927-922 A60 FR	85 °C
929001868602	MASTER LED bulb DT 12-75WE27 927-922 A67 FR	80 °C
929001868702	MASTERLEDbulb DT 15-100WE27 927-922 A67FR	80 °C
929002218602	MASTERLEDbulb DT 14-100WE27 927-922 A67FR	90 °C

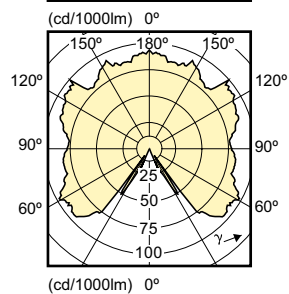
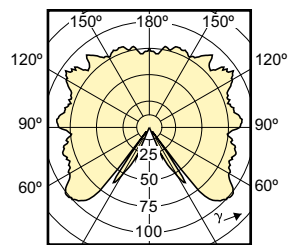
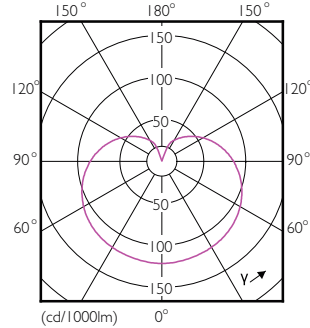
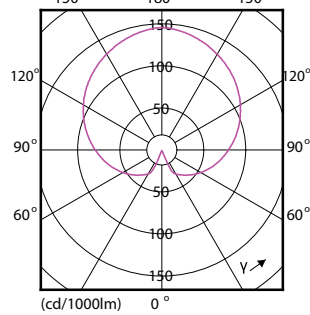
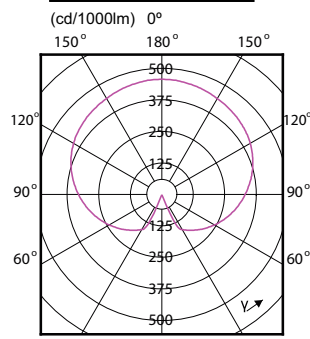
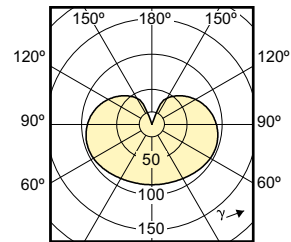

MASTER LEDbulbs

