



# The perfect replacement for mains voltage halogen spots

## MASTER LEDspot MV

Delivering a warm, halogen-like accent beam, MASTER LEDspot MV is a perfect fit for spot lighting (track, corridors, lift lobbies, display cases and cabinets) in the hospitality industry. It is particularly suitable to public areas where the light is on 24/7, such as lobbies, corridors, stairwells. MASTER LEDspot MV delivers huge energy savings and minimizes maintenance cost without any compromise on brightness, enabling hospitality owners to achieve a return on their investment within one year. These LEDspots are compatible with most existing fixtures with a GU10 holder and designed as a retrofit replacement for halogen or incandescent spots. The dimmable versions drive further efficiencies, while helping to create the desired atmosphere.

### Benefits

- Up to 80% energy saving compared with halogen lamps
- Retrofittable
- Lower maintenance costs

### Features

- Compatible with an extensive range of dimmers
- Lifetime of 25,000 to 45,000 hours
- Clearly defined beam spread
- UV- and IR-free light for less heat and protection for heat-sensitive objects

### Application

- Hotels, restaurants, bars, cafés
- Lobbies, corridors, stairwells, washrooms, reception areas

# MASTER LEDspot MV

## Warnings and Safety

- Operating temperature range is between -20° C and 45° C ambient
- Only to apply in dry or damp locations and most of open fixtures with lamp-holders that offer sufficient space (10 mm free air space)
- Not intended for use with emergency light fixtures or exit lights

## Versions



## Dimensional drawing

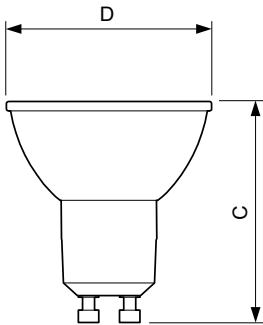

Product	D	C
MASTER LED spot VLE DT 6.2-80W GU10 927 36D	50 mm	56 mm
MASTER LED spot VLE D 650lm GU10 930 120D	50 mm	54 mm
Master LED 4.9-50W GU10 927 36D Dim	50 mm	54 mm
Master LED 4.9-50W GU10 930 36D Dim	50 mm	54 mm
Master LED 4.9-50W GU10 940 36D Dim	50 mm	54 mm
MASTER LED spot VLE D 7-80W GU10 865 36D	50 mm	54 mm
MASTER LED spot VLE D 7-80W GU10 840 36D	50 mm	54 mm
MASTER LED spot VLE D 7-80W GU10 830 36D	50 mm	54 mm
MASTER LED spot VLE DT 4.9-50W GU10 927 36D	50 mm	54 mm
MASTER LED spot VLE D 4.9-50W GU10 940 60D	50 mm	54 mm
MASTER LED spot VLE D 4.9-50W GU10 927 60D	50 mm	54 mm
MASTER LED spot VLE D 4.9-50W GU10 930 60D	50 mm	54 mm
MASTER LED spot VLE D 4.9-50W GU10 927 36D	50 mm	54 mm
MASTER LED spot VLE D 3.7-35W GU10 940 60D	50 mm	54 mm
MASTER LED spot VLE D 3.7-35W GU10 930 60D	50 mm	54 mm
MASTER LED spot VLE D 3.7-35W GU10 927 60D	50 mm	54 mm
MASTER LED spot VLE D 3.7-35W GU10 940 36D	50 mm	54 mm
MASTER LED spot VLE D 3.7-35W GU10 930 36D	50 mm	54 mm

# MASTER LEDspot MV

## Controls and Dimming

Dimmable	Yes
----------	-----

## Operating and Electrical

Input Frequency	50 to 60 Hz
Voltage (Nom)	220-240 V
Starting Time (Nom)	0.5 s

## General Information

Cap-Base	GU10
Nominal Lifetime (Nom)	25000 h
Switching Cycle	50,000X

## Light Technical

Llmf At End Of Nominal Lifetime (Nom)	70 %
---------------------------------------	------

## Mechanical and Housing

Bulb Shape	PAR16
------------	-------

## Approval and Application

Order Code	Full Product Name	Energy Consumption kWh/1000 h	Energy Efficiency Label (EEL)
70775300	MASTER LED spot VLE D 3.7-35W GU10 930 36D	4 kWh	A+
70777700	MASTER LED spot VLE D 3.7-35W GU10 940 36D	4 kWh	A++
70779100	MASTER LED spot VLE D 3.7-35W GU10 927 60D	4 kWh	A+
70781400	MASTER LED spot VLE D 3.7-35W GU10 930 60D	4 kWh	A+
70783800	MASTER LED spot VLE D 3.7-35W GU10 940 60D	4 kWh	A++
70785200	MASTER LED spot VLE D 4.9-50W GU10 927 36D	5 kWh	A+
70731900	Master LED 4.9-50W GU10 927 36D Dim	5 kWh	A+
75592100	Master LED 4.9-50W GU10 930 36D Dim	5 kWh	A+
75594500	Master LED 4.9-50W GU10 940 36D Dim	5 kWh	A+
70791300	MASTER LED spot VLE D 4.9-50W GU10 927 60D	5 kWh	A+
70793700	MASTER LED spot VLE D 4.9-50W GU10 930 60D	5 kWh	A+
70795100	MASTER LED spot VLE D 4.9-50W GU10 940 60D	5 kWh	A+
70797500	MASTER LED spot VLE D 7-80W GU10 830 36D	7 kWh	A+
70799900	MASTER LED spot VLE D 7-80W GU10 840 36D	7 kWh	A+
70801900	MASTER LED spot VLE D 7-80W GU10 865 36D	7 kWh	A+
70811800	MASTER LED spot VLE DT 4.9-50W GU10 927 36D	5 kWh	A+
66271400	MASTER LED spot VLE DT 6.2-80W GU10 927 36D	7 kWh	A++
70609800	MASTER LED spot VLE D 650lm GU10 930 120D	7 kWh	A+

## Operating and Electrical

Order Code	Full Product Name	Wattage Equivalent	Power (Rated) (Nom)	Order Code	Full Product Name	Wattage Equivalent	Power (Rated) (Nom)
70775300	MASTER LED spot VLE D 3.7-35W GU10 930 36D	35 W	3.7 W	70791300	MASTER LED spot VLE D 4.9-50W GU10 927 60D	50 W	4.9 W
70777700	MASTER LED spot VLE D 3.7-35W GU10 940 36D	35 W	3.7 W	70793700	MASTER LED spot VLE D 4.9-50W GU10 930 60D	50 W	4.9 W
70779100	MASTER LED spot VLE D 3.7-35W GU10 927 60D	35 W	3.7 W	70795100	MASTER LED spot VLE D 4.9-50W GU10 940 60D	50 W	4.9 W
70781400	MASTER LED spot VLE D 3.7-35W GU10 930 60D	35 W	3.7 W	70797500	MASTER LED spot VLE D 7-80W GU10 830 36D	80 W	7 W
70783800	MASTER LED spot VLE D 3.7-35W GU10 940 60D	35 W	3.7 W	70799900	MASTER LED spot VLE D 7-80W GU10 840 36D	80 W	7 W
70785200	MASTER LED spot VLE D 4.9-50W GU10 927 36D	50 W	4.9 W	70801900	MASTER LED spot VLE D 7-80W GU10 865 36D	80 W	7 W
70731900	Master LED 4.9-50W GU10 927 36D Dim	50 W	5 W	70811800	MASTER LED spot VLE DT 4.9-50W GU10 927 36D	50 W	4.9 W
75592100	Master LED 4.9-50W GU10 930 36D Dim	50 W	5 W	66271400	MASTER LED spot VLE DT 6.2-80W GU10 927 36D	80 W	6.2 W
75594500	Master LED 4.9-50W GU10 940 36D Dim	50 W	5 W	70609800	MASTER LED spot VLE D 650lm GU10 930 120D	-	6.2 W

## Light Technical (1/2)

## MASTER LEDspot MV

Order Code	Full Product Name	Beam Angle (Nom)	Colour Code	Correlated Colour Temperature (Nom)	Colour Rendering Index (Nom)
70775300	MASTER LED spot VLE D 3.7-35W GU10 930 36D	36 °	930	3000 K	90
70777700	MASTER LED spot VLE D 3.7-35W GU10 940 36D	36 °	940	4000 K	90
70779100	MASTER LED spot VLE D 3.7-35W GU10 927 60D	60 °	927	2700 K	90
70781400	MASTER LED spot VLE D 3.7-35W GU10 930 60D	60 °	930	3000 K	90
70783800	MASTER LED spot VLE D 3.7-35W GU10 940 60D	60 °	940	4000 K	90
70785200	MASTER LED spot VLE D 4.9-50W GU10 927 36D	36 °	927	2700 K	90
70731900	Master LED 4.9-50W GU10 927 36D Dim	36 °	927	2700 K	90
75592100	Master LED 4.9-50W GU10 930 36D Dim	36 °	930	3000 K	90
75594500	Master LED 4.9-50W GU10 940 36D Dim	36 °	940	4000 K	90
70791300	MASTER LED spot VLE D 4.9-50W GU10 927 60D	60 °	927	2700 K	90

Order Code	Full Product Name	Beam Angle (Nom)	Colour Code	Correlated Colour Temperature (Nom)	Colour Rendering Index (Nom)
70793700	MASTER LED spot VLE D 4.9-50W GU10 930 60D	60 °	930	3000 K	90
70795100	MASTER LED spot VLE D 4.9-50W GU10 940 60D	60 °	940	4000 K	90
70797500	MASTER LED spot VLE D 7-80W GU10 830 36D	36 °	830	3000 K	80
70799900	MASTER LED spot VLE D 7-80W GU10 840 36D	36 °	841	4000 K	80
70801900	MASTER LED spot VLE D 7-80W GU10 865 36D	36 °	865	6500 K	80
70811800	MASTER LED spot VLE DT 4.9-50W GU10 927 36D	36 °	922-927	2700 K	90
66271400	MASTER LED spot VLE DT 6.2-80W GU10 927 36D	36 °	922-927	2700 K	90
70609800	MASTER LED spot VLE D 650lm GU10 930 120D	120 °	930	3000 K	90

### Light Technical (2/2)

Order Code	Full Product Name	Luminous Flux (Nom)	Luminous Intensity (Nom)
70775300	MASTER LED spot VLE D 3.7-35W GU10 930 36D	270 lm	500 cd
70777700	MASTER LED spot VLE D 3.7-35W GU10 940 36D	285 lm	500 cd
70779100	MASTER LED spot VLE D 3.7-35W GU10 927 60D	260 lm	330 cd
70781400	MASTER LED spot VLE D 3.7-35W GU10 930 60D	270 lm	340 cd
70783800	MASTER LED spot VLE D 3.7-35W GU10 940 60D	285 lm	350 cd
70785200	MASTER LED spot VLE D 4.9-50W GU10 927 36D	355 lm	650 cd
70731900	Master LED 4.9-50W GU10 927 36D Dim	395 lm	650 cd
75592100	Master LED 4.9-50W GU10 930 36D Dim	405 lm	650 cd

Order Code	Full Product Name	Luminous Flux (Nom)	Luminous Intensity (Nom)
75594500	Master LED 4.9-50W GU10 940 36D Dim	420 lm	700 cd
70791300	MASTER LED spot VLE D 4.9-50W GU10 927 60D	355 lm	400 cd
70793700	MASTER LED spot VLE D 4.9-50W GU10 930 60D	365 lm	400 cd
70795100	MASTER LED spot VLE D 4.9-50W GU10 940 60D	380 lm	400 cd
70797500	MASTER LED spot VLE D 7-80W GU10 830 36D	590 lm	1200 cd
70799900	MASTER LED spot VLE D 7-80W GU10 840 36D	610 lm	1200 cd
70801900	MASTER LED spot VLE D 7-80W GU10 865 36D	610 lm	1200 cd
70811800	MASTER LED spot VLE DT 4.9-50W GU10 927 36D	355 lm	650 cd

# MASTER LEDspot MV

Order Code	Full Product Name	Luminous Flux (Nom)	Luminous Intensity (Nom)
66271400	MASTER LED spot VLE DT 6.2-80W GU10 927 36D	575 lm	950 cd

Order Code	Full Product Name	Luminous Flux (Nom)	Luminous Intensity (Nom)
70609800	MASTER LED spot VLE D 650lm GU10 930 120D	650 lm	200 cd

## Temperature

Order Code	Full Product Name	T-Case Maximum (Nom)
70775300	MASTER LED spot VLE D 3.7-35W GU10 930 36D	80 °C
70777700	MASTER LED spot VLE D 3.7-35W GU10 940 36D	80 °C
70779100	MASTER LED spot VLE D 3.7-35W GU10 927 60D	80 °C
70781400	MASTER LED spot VLE D 3.7-35W GU10 930 60D	80 °C
70783800	MASTER LED spot VLE D 3.7-35W GU10 940 60D	80 °C
70785200	MASTER LED spot VLE D 4.9-50W GU10 927 36D	80 °C
70731900	Master LED 4.9-50W GU10 927 36D Dim	80 °C
75592100	Master LED 4.9-50W GU10 930 36D Dim	80 °C
75594500	Master LED 4.9-50W GU10 940 36D Dim	80 °C
70791300	MASTER LED spot VLE D 4.9-50W GU10 927 60D	80 °C
70793700	MASTER LED spot VLE D 4.9-50W GU10 930 60D	80 °C
70795100	MASTER LED spot VLE D 4.9-50W GU10 940 60D	80 °C
70797500	MASTER LED spot VLE D 7-80W GU10 830 36D	85 °C
70799900	MASTER LED spot VLE D 7-80W GU10 840 36D	85 °C
70801900	MASTER LED spot VLE D 7-80W GU10 865 36D	85 °C
70811800	MASTER LED spot VLE DT 4.9-50W GU10 927 36D	80 °C
66271400	MASTER LED spot VLE DT 6.2-80W GU10 927 36D	75 °C
70609800	MASTER LED spot VLE D 650lm GU10 930 120D	80 °C

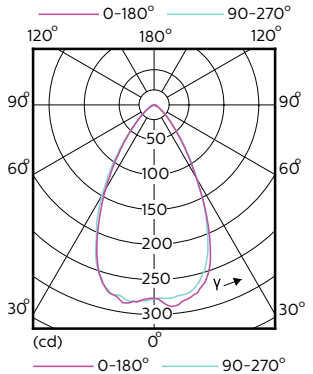
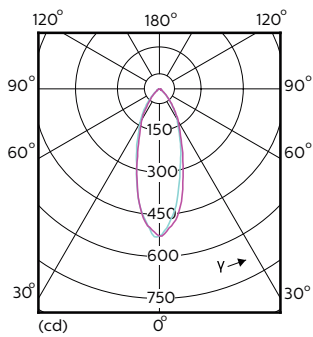

# MASTER LEDspot MV

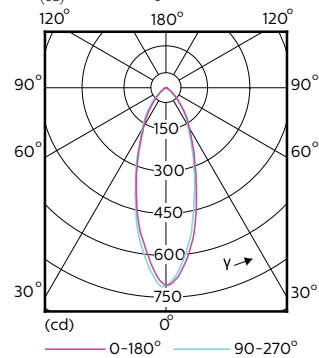
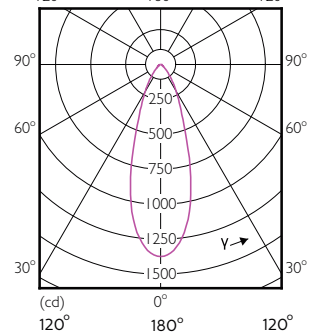
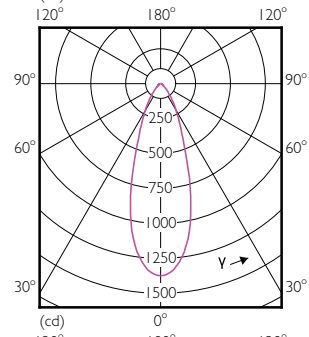
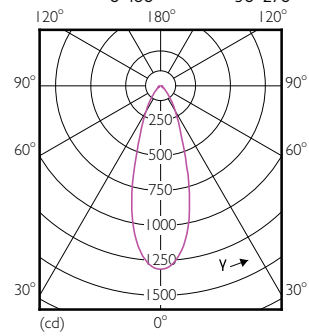
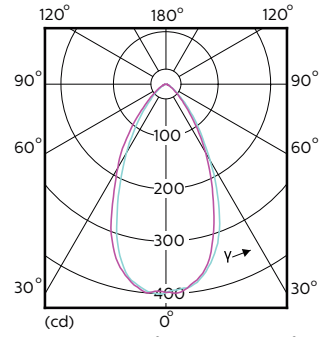

# MASTER LEDspot MV

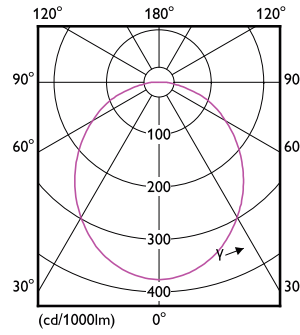
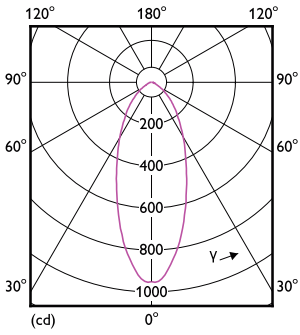

## Accent Diagrams

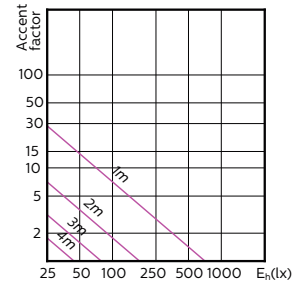
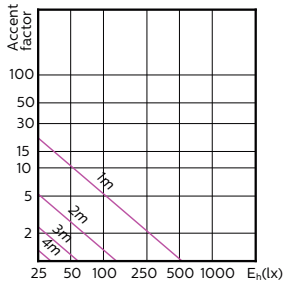

MASTER LEDspotMV 35W GU10 36D 260lm

MASTER LEDspotMV 35W GU10 60D 260lm

MASTER LEDspotMV 50W GU10 36D 355lm

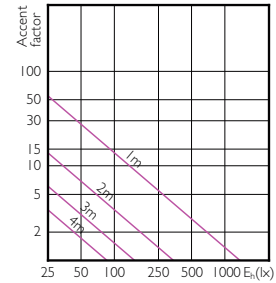
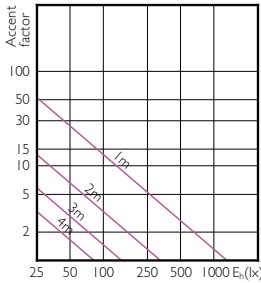
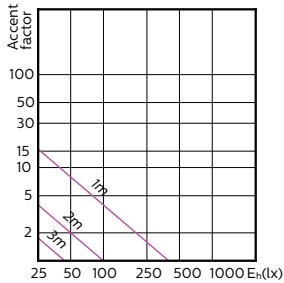

MASTER LEDspotMV 50W GU10 60D 355lm

MASTER LEDspotMV 80W GU10 830 36D

MASTER LEDspotMV 80W GU10 840 36D

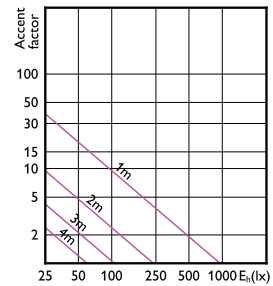
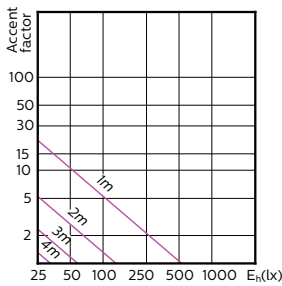
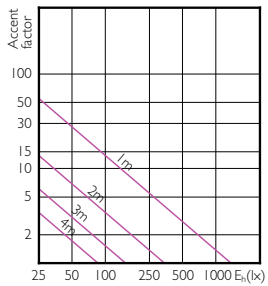

MASTER LEDspotMV 80W GU10 865 36D VLE

MASTER LEDspotMV 50W GU10 922-927 36D

GU10 7.5-80W 650lm 2700K GU10 D 15khrs

# MASTER LEDspot MV

## Beam Diagrams

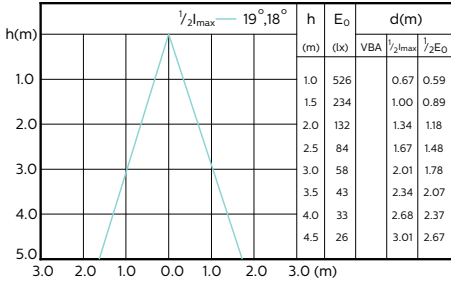

MASTER LEDspotMV 35W GU10 36D 260lm

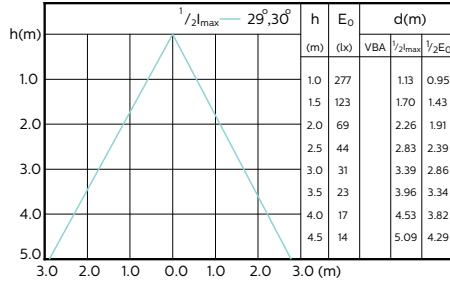

MASTER LEDspotMV 35W GU10 60D 260lm

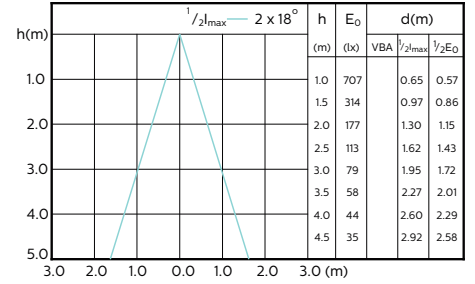

MASTER LEDspotMV 50W GU10 36D 355lm

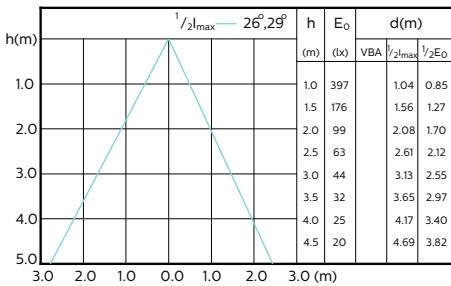

MASTER LEDspotMV 50W GU10 60D 355lm

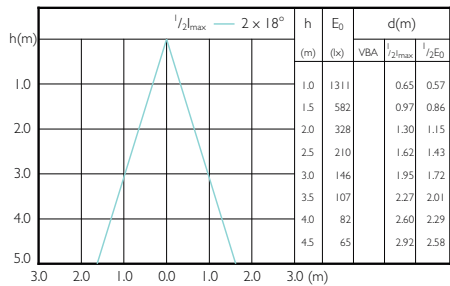

MASTER LEDspotMV 80W GU10 830 36D

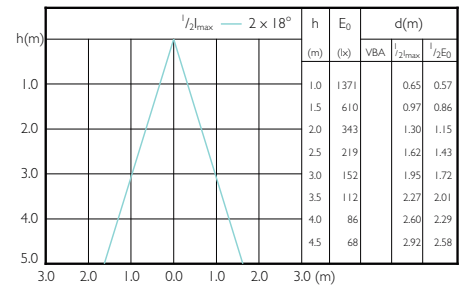

MASTER LEDspotMV 80W GU10 840 36D

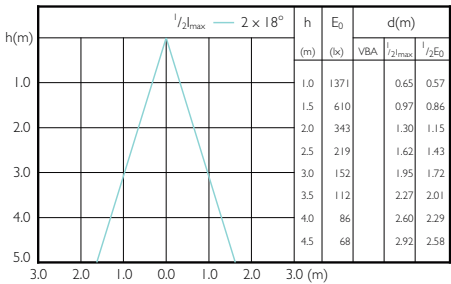

MASTER LEDspotMV 80W GU10 865 36D VLE

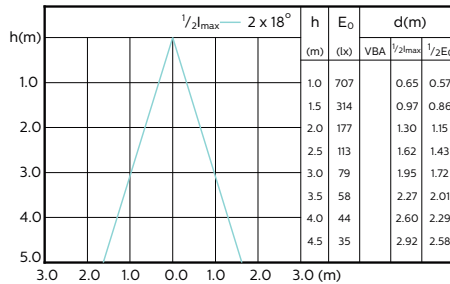

MASTER LEDspotMV 50W GU10 922-927 36D

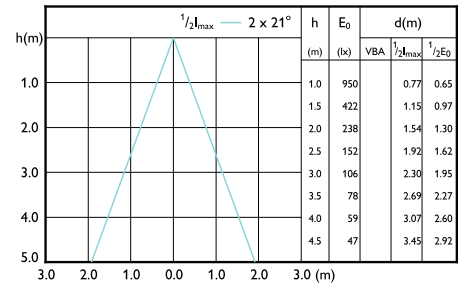

GU10 7.5-80W 650lm 2700K GU10 D 15khrs

