



The perfect replacement for mains voltage halogen spots

MASTER LEDspot MV

Delivering a warm, halogen-like accent beam, MASTER LEDspot MV is a perfect fit for spot lighting (track, corridors, lift lobbies, display cases and cabinets) in the hospitality industry. It is particularly suitable to public areas where the light is on 24/7, such as lobbies, corridors, stairwells. MASTER LEDspot MV delivers huge energy savings and minimises maintenance cost without any compromise on brightness, enabling hospitality owners to achieve a return on their investment within one year. These LEDspots are compatible with most existing fixtures with a GU10 holder and designed as a retrofit replacement for halogen or incandescent spots. The dimmable versions drive further efficiencies, while helping to create the desired atmosphere. For environments where the right atmosphere needs to be created (e.g. bars and restaurants), the “DimTone” feature could be useful. This is a LED feature that creates a warmer tone once light is dimmed down to lower intensities.

Benefits

Features

Application

Warnings and Safety

MASTER LEDspot MV

Versions



Dimensional drawing

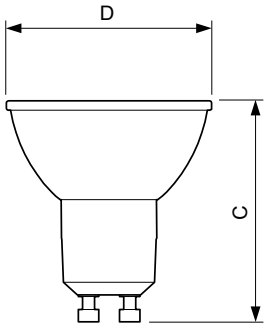

Product	D	C
MASTER LED spot VLE D 6.2-80W GU10 927 36D	50 mm	54 mm
MASTER LED spot VLE D 680lm GU10 965 120D	50 mm	54 mm
MASTER LED spot VLE D 6.2-80W GU10 940 36D	50 mm	54 mm
MASTER LED spot VLE D 680lm GU10 940 120D	50 mm	54 mm
MASTER LED spot VLE D 6.2-80W GU10 965 36D	50 mm	54 mm
MASTER LED spot VLE D 650lm GU10 930 120D	50 mm	54 mm
MASTER LED spot VLE D 6.2-80W GU10 930 36D	50 mm	54 mm
MASTER LED spot VLE DT 4.9-50W GU10 927 36D	50 mm	54 mm
MASTER LED spot VLE DT 3.7-35W GU10 927 36D	50 mm	54 mm
MASTER LED spot VLE D 4.9-50W GU10 940 60D	50 mm	54 mm
MASTER LED spot VLE D 4.9-50W GU10 930 60D	50 mm	54 mm
MASTER LED spot VLE D 4.9-50W GU10 930 36D	50 mm	54 mm
MASTER LED spot VLE D 4.9-50W GU10 940 36D	50 mm	54 mm
MASTER LED spot VLE D 4.9-50W GU10 927 36D	50 mm	54 mm
MASTER LED spot VLE D 3.7-35W GU10 940 60D	50 mm	54 mm
MASTER LED spot VLE D 3.7-35W GU10 930 60D	50 mm	54 mm
MASTER LED spot VLE D 3.7-35W GU10 927 60D	50 mm	54 mm
MASTER LED spot VLE D 3.7-35W GU10 940 36D	50 mm	54 mm
MASTER LED spot VLE D 3.7-35W GU10 930 36D	50 mm	54 mm
MASTER LED spot VLE D 3.7-35W GU10 927 36D	50 mm	54 mm

MASTER LEDspot MV

Operating and Electrical

Input Frequency	50 to 60 Hz
Voltage (Nom)	220-240 V
Starting Time (Nom)	0.5 s

General Information

Cap-Base	GU10
Nominal Lifetime (Nom)	25000 h
Switching Cycle	50000X

Light Technical

Colour Rendering Index (Nom)	90
Llmf At End Of Nominal Lifetime (Nom)	70 %

Mechanical and Housing

Bulb Shape	PAR16
------------	-------

Temperature

T-Case Maximum (Nom)	80 °C
----------------------	-------

Approval and Application

Order Code	Full Product Name	Energy Consumption kWh/1000 h	Energy Efficiency Label (EEL)
70773900	MASTER LED spot VLE D 3.7-35W GU10 927 36D	4 kWh	A+
70775300	MASTER LED spot VLE D 3.7-35W GU10 930 36D	4 kWh	A+
70777700	MASTER LED spot VLE D 3.7-35W GU10 940 36D	4 kWh	A++
70779100	MASTER LED spot VLE D 3.7-35W GU10 927 60D	4 kWh	A+
70781400	MASTER LED spot VLE D 3.7-35W GU10 930 60D	4 kWh	A+
70783800	MASTER LED spot VLE D 3.7-35W GU10 940 60D	4 kWh	A++
70785200	MASTER LED spot VLE D 4.9-50W GU10 927 36D	5 kWh	A+
70787600	MASTER LED spot VLE D 4.9-50W GU10 930 36D	5 kWh	A+
70789000	MASTER LED spot VLE D 4.9-50W GU10 940 36D	5 kWh	A+
70793700	MASTER LED spot VLE D 4.9-50W GU10 930 60D	5 kWh	A+
70795100	MASTER LED spot VLE D 4.9-50W GU10 940 60D	5 kWh	A+
70809500	MASTER LED spot VLE DT 3.7-35W GU10 927 36D	4 kWh	A+
70811800	MASTER LED spot VLE DT 4.9-50W GU10 927 36D	5 kWh	A+
67541700	MASTER LED spot VLE D 6.2-80W GU10 927 36D	7 kWh	A++
70523700	MASTER LED spot VLE D 6.2-80W GU10 940 36D	7 kWh	A++
70525100	MASTER LED spot VLE D 6.2-80W GU10 930 36D	7 kWh	A++
70607400	MASTER LED spot VLE D 6.2-80W GU10 965 36D	7 kWh	A++
70609800	MASTER LED spot VLE D 650lm GU10 930 120D	7 kWh	A+
70611100	MASTER LED spot VLE D 680lm GU10 940 120D	7 kWh	A+
70613500	MASTER LED spot VLE D 680lm GU10 965 120D	7 kWh	A+

Controls and Dimming

Order Code	Full Product Name	Dimmable	Order Code	Full Product Name	Dimmable
70773900	MASTER LED spot VLE D 3.7-35W GU10 927 36D	Yes	70795100	MASTER LED spot VLE D 4.9-50W GU10 940 60D	Yes
70775300	MASTER LED spot VLE D 3.7-35W GU10 930 36D	yes	70809500	MASTER LED spot VLE DT 3.7-35W GU10 927 36D	Yes
70777700	MASTER LED spot VLE D 3.7-35W GU10 940 36D	yes	70811800	MASTER LED spot VLE DT 4.9-50W GU10 927 36D	Yes
70779100	MASTER LED spot VLE D 3.7-35W GU10 927 60D	Yes	67541700	MASTER LED spot VLE D 6.2-80W GU10 927 36D	Yes
70781400	MASTER LED spot VLE D 3.7-35W GU10 930 60D	yes	70523700	MASTER LED spot VLE D 6.2-80W GU10 940 36D	Yes
70783800	MASTER LED spot VLE D 3.7-35W GU10 940 60D	yes	70525100	MASTER LED spot VLE D 6.2-80W GU10 930 36D	Yes
70785200	MASTER LED spot VLE D 4.9-50W GU10 927 36D	yes	70607400	MASTER LED spot VLE D 6.2-80W GU10 965 36D	Yes
70787600	MASTER LED spot VLE D 4.9-50W GU10 930 36D	Yes	70609800	MASTER LED spot VLE D 650lm GU10 930 120D	Yes
70789000	MASTER LED spot VLE D 4.9-50W GU10 940 36D	Yes	70611100	MASTER LED spot VLE D 680lm GU10 940 120D	Yes
70793700	MASTER LED spot VLE D 4.9-50W GU10 930 60D	Yes	70613500	MASTER LED spot VLE D 680lm GU10 965 120D	Yes

Operating and Electrical

Order Code	Full Product Name	Wattage Equivalent	Power (Rated) (Nom)	Order Code	Full Product Name	Wattage Equivalent	Power (Rated) (Nom)
70773900	MASTER LED spot VLE D 3.7-35W GU10 927 36D	35 W	3.7 W	70783800	MASTER LED spot VLE D 3.7-35W GU10 940 60D	35 W	3.7 W
70775300	MASTER LED spot VLE D 3.7-35W GU10 930 36D	35 W	3.7 W	70785200	MASTER LED spot VLE D 4.9-50W GU10 927 36D	50 W	4.9 W
70777700	MASTER LED spot VLE D 3.7-35W GU10 940 36D	35 W	3.7 W	70787600	MASTER LED spot VLE D 4.9-50W GU10 930 36D	50 W	4.9 W
70779100	MASTER LED spot VLE D 3.7-35W GU10 927 60D	35 W	3.7 W	70789000	MASTER LED spot VLE D 4.9-50W GU10 940 36D	50 W	4.9 W
70781400	MASTER LED spot VLE D 3.7-35W GU10 930 60D	35 W	3.7 W	70793700	MASTER LED spot VLE D 4.9-50W GU10 930 60D	50 W	4.9 W

MASTER LEDspot MV

Order Code	Full Product Name	Wattage Equivalent	Power (Rated) (Nom)
70795100	MASTER LED spot VLE D 4.9-50W GU10 940 60D	50 W	4.9 W
70809500	MASTER LED spot VLE DT 3.7-35W GU10 927 36D	35 W	3.7 W
70811800	MASTER LED spot VLE DT 4.9-50W GU10 927 36D	50 W	4.9 W
67541700	MASTER LED spot VLE D 6.2-80W GU10 927 36D	80 W	6.2 W
70523700	MASTER LED spot VLE D 6.2-80W GU10 940 36D	80 W	6.2 W

Order Code	Full Product Name	Wattage Equivalent	Power (Rated) (Nom)
70525100	MASTER LED spot VLE D 6.2-80W GU10 930 36D	80 W	6.2 W
70607400	MASTER LED spot VLE D 6.2-80W GU10 965 36D	80 W	6.2 W
70609800	MASTER LED spot VLE D 650lm GU10 930 120D	-	6.2 W
70611100	MASTER LED spot VLE D 680lm GU10 940 120D	-	6.2 W
70613500	MASTER LED spot VLE D 680lm GU10 965 120D	-	6.2 W

Light Technical (1/2)

Order Code	Full Product Name	Beam	Colour Code	Correlated Colour	Luminous Flux (Nom)
		Angle (Nom)		Temperature (Nom)	
70773900	MASTER LED spot VLE D 3.7-35W GU10 927 36D	36 °	927	2700 K	260 lm
70775300	MASTER LED spot VLE D 3.7-35W GU10 930 36D	36 °	930	3000 K	270 lm
70777700	MASTER LED spot VLE D 3.7-35W GU10 940 36D	36 °	940	4000 K	285 lm
70779100	MASTER LED spot VLE D 3.7-35W GU10 927 60D	60 °	927	2700 K	260 lm
70781400	MASTER LED spot VLE D 3.7-35W GU10 930 60D	60 °	930	3000 K	270 lm
70783800	MASTER LED spot VLE D 3.7-35W GU10 940 60D	60 °	940	4000 K	285 lm
70785200	MASTER LED spot VLE D 4.9-50W GU10 927 36D	36 °	927	2700 K	355 lm
70787600	MASTER LED spot VLE D 4.9-50W GU10 930 36D	36 °	930	3000 K	365 lm
70789000	MASTER LED spot VLE D 4.9-50W GU10 940 36D	36 °	940	4000 K	380 lm
70793700	MASTER LED spot VLE D 4.9-50W GU10 930 60D	60 °	930	3000 K	365 lm

Order Code	Full Product Name	Beam	Colour Code	Correlated Colour	Luminous Flux (Nom)
		Angle (Nom)		Temperature (Nom)	
70795100	MASTER LED spot VLE D 4.9-50W GU10 940 60D	60 °	940	4000 K	380 lm
70809500	MASTER LED spot VLE DT 3.7-35W GU10 927 36D	36 °	922-927	-	260 lm
70811800	MASTER LED spot VLE DT 4.9-50W GU10 927 36D	36 °	922-927	-	355 lm
67541700	MASTER LED spot VLE D 6.2-80W GU10 927 36D	36 °	927	2700 K	575 lm
70523700	MASTER LED spot VLE D 6.2-80W GU10 940 36D	36 °	940	4000 K	575 lm
70525100	MASTER LED spot VLE D 6.2-80W GU10 930 36D	36 °	930	3000 K	575 lm
70607400	MASTER LED spot VLE D 6.2-80W GU10 965 36D	36 °	6500	6500 K	575 lm
70609800	MASTER LED spot VLE D 650lm GU10 930 120D	120 °	930	3000 K	650 lm
70611100	MASTER LED spot VLE D 680lm GU10 940 120D	120 °	940	4000 K	680 lm
70613500	MASTER LED spot VLE D 680lm GU10 965 120D	120 °	6500	6500 K	680 lm

Light Technical (2/2)

MASTER LEDspot MV

Order Code	Full Product Name	Luminous Intensity (Nom)
70773900	MASTER LED spot VLE D 3.7-35W GU10 927 36D	500 cd
70775300	MASTER LED spot VLE D 3.7-35W GU10 930 36D	500 cd
70777700	MASTER LED spot VLE D 3.7-35W GU10 940 36D	500 cd
70779100	MASTER LED spot VLE D 3.7-35W GU10 927 60D	330 cd
70781400	MASTER LED spot VLE D 3.7-35W GU10 930 60D	340 cd
70783800	MASTER LED spot VLE D 3.7-35W GU10 940 60D	350 cd
70785200	MASTER LED spot VLE D 4.9-50W GU10 927 36D	650 cd
70787600	MASTER LED spot VLE D 4.9-50W GU10 930 36D	650 cd
70789000	MASTER LED spot VLE D 4.9-50W GU10 940 36D	700 cd
70793700	MASTER LED spot VLE D 4.9-50W GU10 930 60D	400 cd
70795100	MASTER LED spot VLE D 4.9-50W GU10 940 60D	400 cd
70809500	MASTER LED spot VLE DT 3.7-35W GU10 927 36D	500 cd
70811800	MASTER LED spot VLE DT 4.9-50W GU10 927 36D	650 cd
67541700	MASTER LED spot VLE D 6.2-80W GU10 927 36D	850 cd
70523700	MASTER LED spot VLE D 6.2-80W GU10 940 36D	850 cd
70525100	MASTER LED spot VLE D 6.2-80W GU10 930 36D	850 cd
70607400	MASTER LED spot VLE D 6.2-80W GU10 965 36D	850 cd
70609800	MASTER LED spot VLE D 650lm GU10 930 120D	200 cd
70611100	MASTER LED spot VLE D 680lm GU10 940 120D	200 cd
70613500	MASTER LED spot VLE D 680lm GU10 965 120D	200 cd

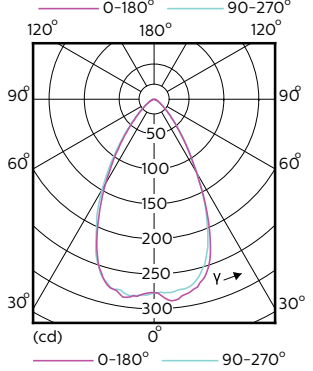
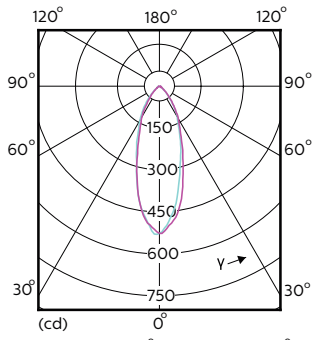

MASTER LEDspot MV

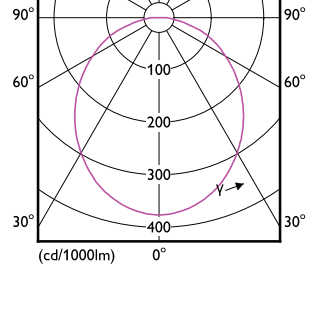
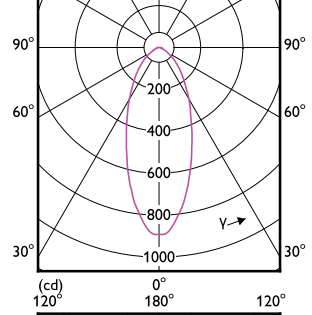
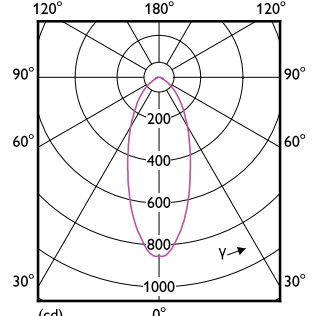
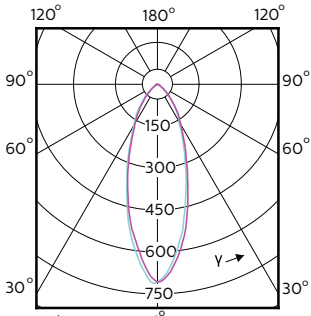
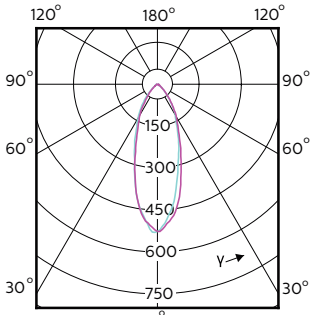
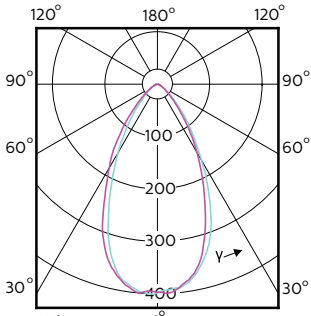

Accent Diagrams

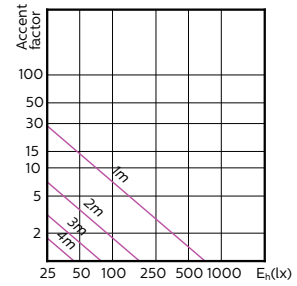
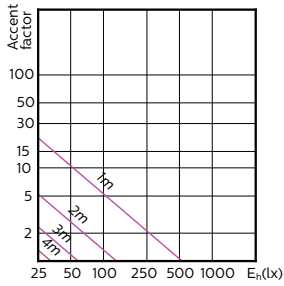

MASTER LEDspotMV 35W GU10 36D 260lm

MASTER LEDspotMV 35W GU10 60D 260lm

MASTER LEDspotMV 50W GU10 36D 355lm

Accent Diagrams

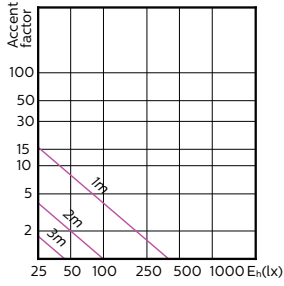

MASTER LEDspotMV 50W GU10 60D 355lm

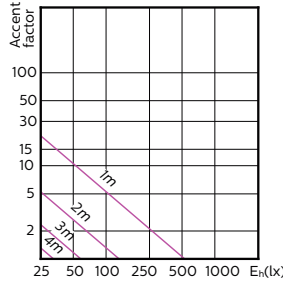

MASTER LEDspotMV 35W GU10 922-927 36D

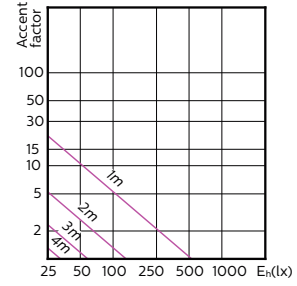

MASTER LEDspotMV 50W GU10 922-927 36D

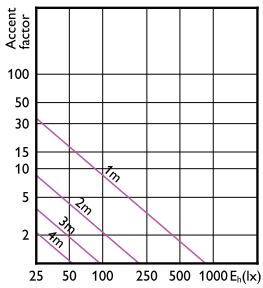

GU10 7.5-80W 650lm 2700K GU10 D 25khrs

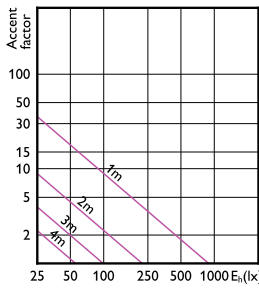

GU10 7.5-80W 680lm 36D 4000K GU10 15khrs

Beam Diagrams

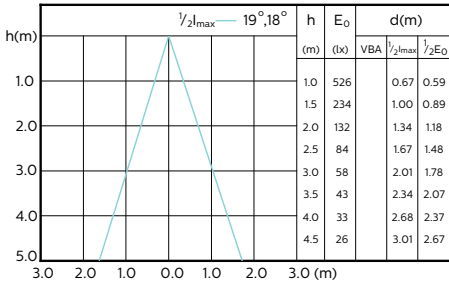

MASTER LEDspotMV 35W GU10 36D 260lm

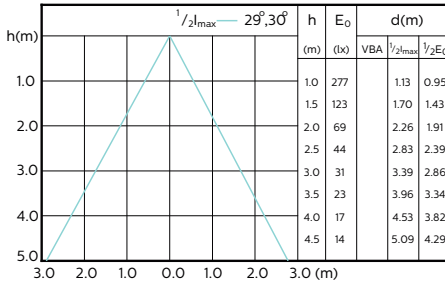

MASTER LEDspotMV 35W GU10 60D 260lm

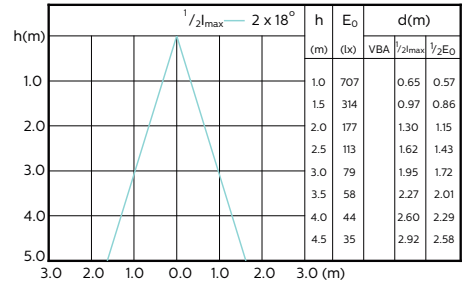

MASTER LEDspotMV 50W GU10 36D 355lm

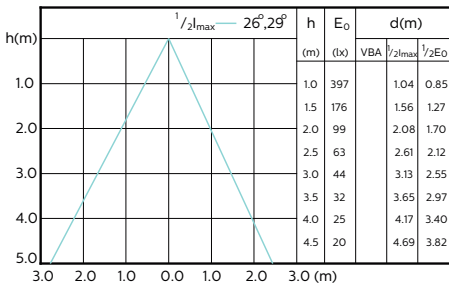

MASTER LEDspotMV 50W GU10 60D 355lm

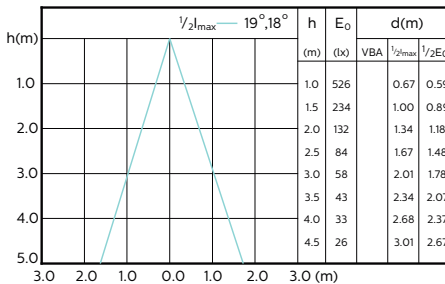

MASTER LEDspotMV 35W GU10 922-927 36D

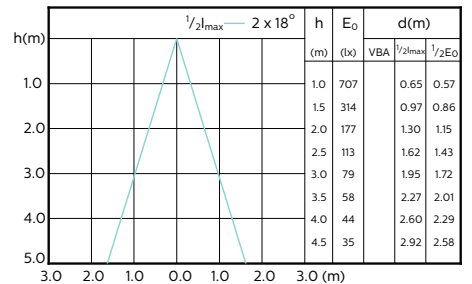

MASTER LEDspotMV 50W GU10 922-927 36D

MASTER LEDspot MV

Beam Diagrams

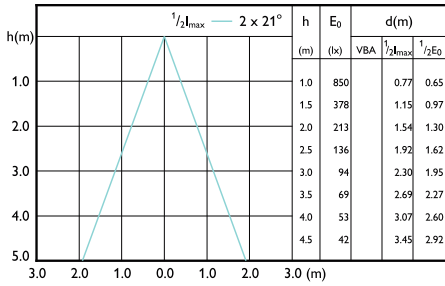

GU10 7.5-80W 650lm 2700K GU10 D 25khrs

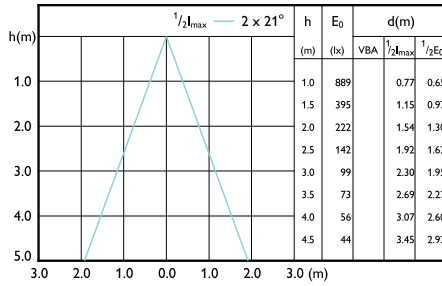

GU10 7.5-80W 680lm 36D 4000K GU10 15khrs

