



# RCS750 3-fasen railsysteem - flexibel en multifunctioneel

## 3-fasen rail RCS750

Het RCS750 3-fasen railsysteem bestaat uit een massieve aluminiumrail in lengtes van 1, 2, 3 en 4 meter met vier gescheiden koperen geleiders. Je kan moeiteloos elke gewenste configuratie creëren: horizontaal of verticaal, op of in het plafond, op muren of op vrijstaande panelen. Het systeem kan ook gependeld worden gebruikt. Armaturen hebben een eigen voeding en kunnen apart worden in- en uitgeschakeld. Armaturen kunnen eenvoudig verplaatst worden als je verlichting of presentatie wilt wijzigen. Op deze manier kan je een multifunctioneel railsysteem creëren voor accentverlichting en voor hangend reclame- of decoratiemateriaal. Er zijn diverse accessoires en montagematerialen verkrijgbaar.

### Voordelen

- Flexibel railsysteem
- Eenvoudig te koppelen en te verlengen
- Duurzame materialen en fraaie afwerking

### Kenmerken

- Kan worden gebruikt met alle Philips LED-spots op 3-fasen spanningsrails
- Verkrijgbaar in lengtes van 1, 2, 3 en 4 m
- Uitgebreide reeks adapters, voedingsaansluitingen en montageaccessoires verkrijgbaar

### Toepassing

- Retail
- Indoor architectural lighting

## 3-fasen rail RCS750

### Versions

ZRS750 CPF BK (XTS23-2)



ZRS750 CPS BK (XTS14-2)



ZRS750 TCPR WH (XTS36-3)



ZRS750 CPF WH (XTS23-3)



ZRS750 EPSR BK (XTS11-2+41-2)



ZRS750 EPSL BK (XTS12-2+41-2)



ZRS750 CPS WH (XTS14-3)



ZRS750 CCPI WH (XTS34-3)



# 3-fasen rail RCS750

## Versions

ZRS750 CPX WH (XTS38-3)



ZRS750 EP BK (XTS41-2)



ZRS750 EP WH (XTS41-3)



ZRS750 ICP WH (XTS21-3)



ZRS750 TCPL WH (XTS39-3)



ZRS750 CS WH (XTSP11-3)



ZRS750 ACP WH (XTS24-3)



ZRS750 3C BA WH (GA70-3)



## 3-fasen rail RCS750

### Versions

ZRS750 CCPE WH (XTS35-3)



ZRS750 EPSL WH (XTS12-3+41-3)



ZRS750 TCPR BK (XTS36-2)



ZRS700 SPCL ALU SUSP CLAMP L (SKB18-1)



RCS750 track, black



ZCS750 5C6 CPF BK (XTSC623-2)



ZRS700 MBW6 ALU WALL BRACKET (SKB21-1)



ZRS750 ICP BK (XTS21-2)



# 3-fasen rail RCS750

## Maatschets

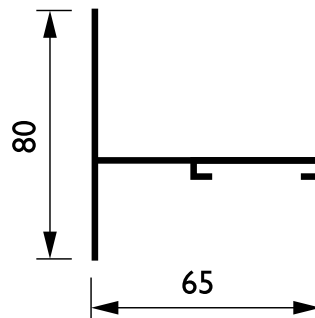
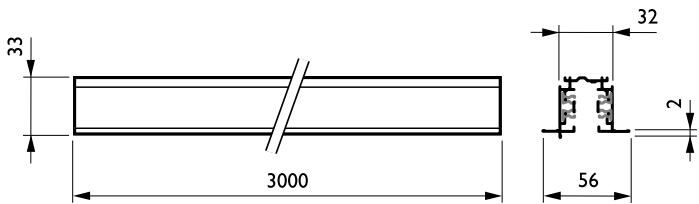
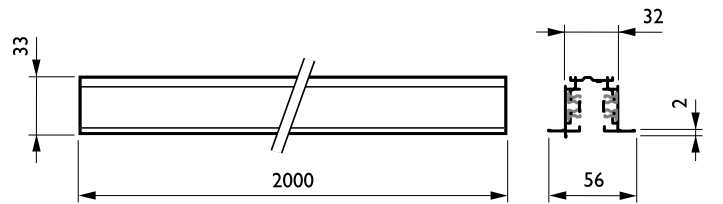
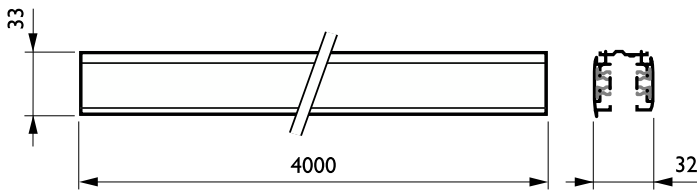
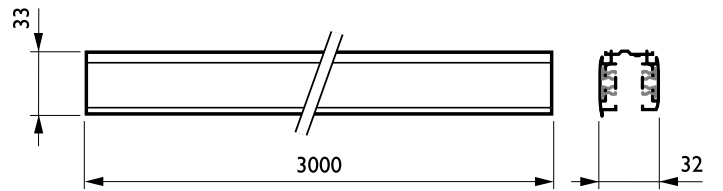
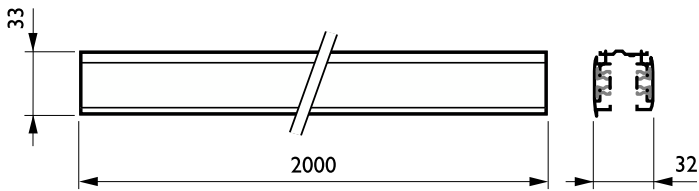
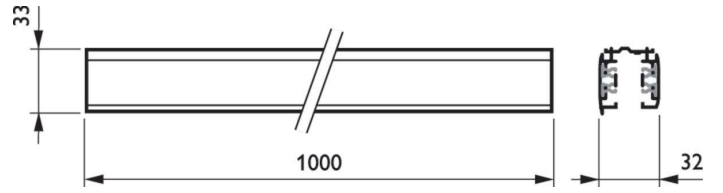

## 3-fasen rail RCS750

### Maatschets

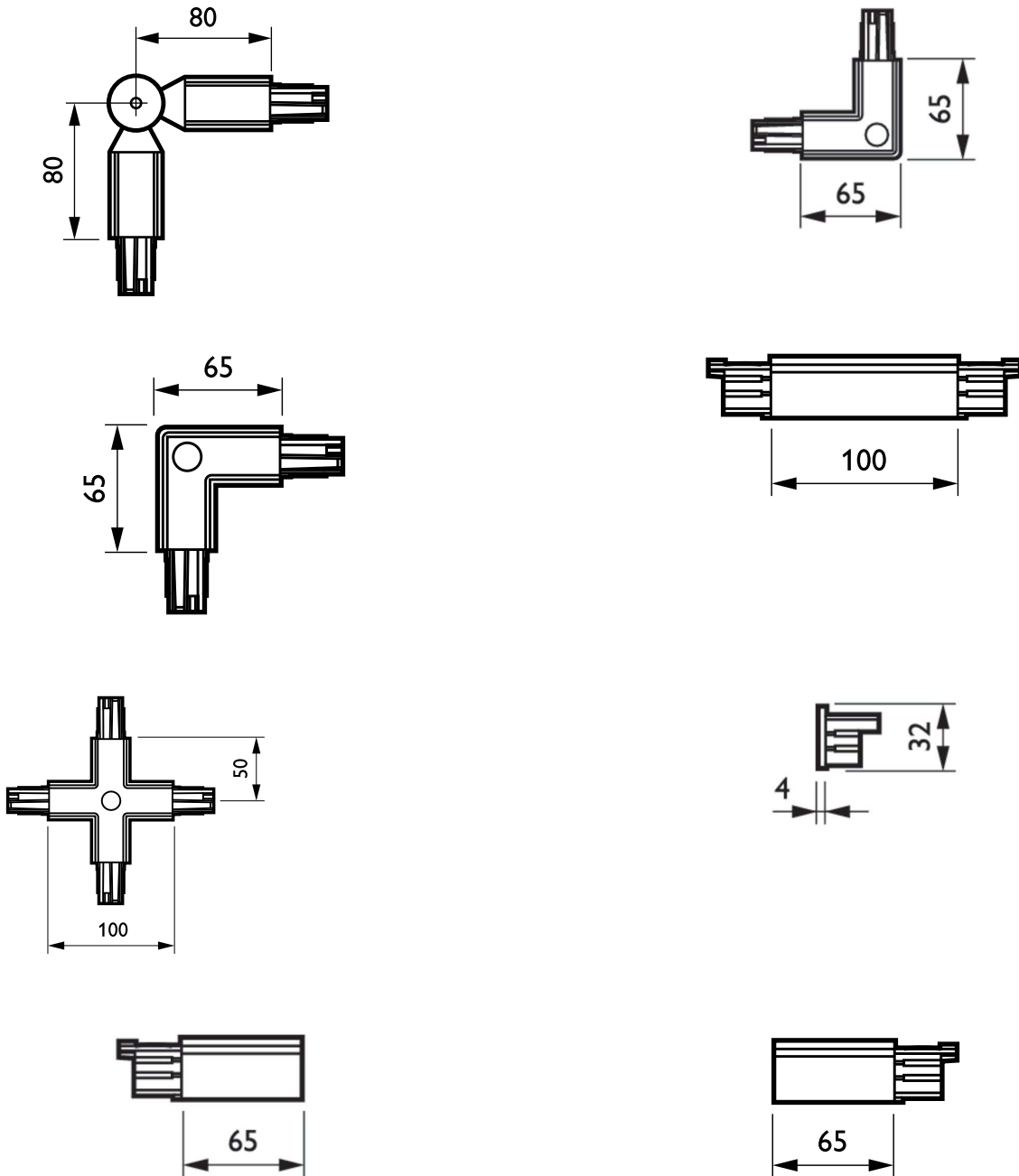

## 3-fasen rail RCS750

### Maatschets

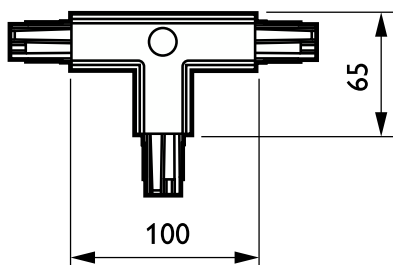
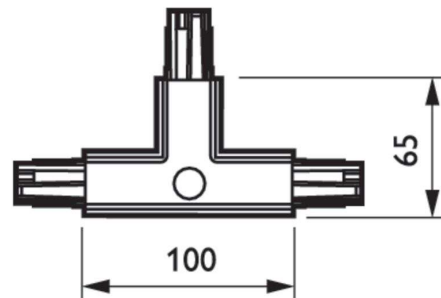
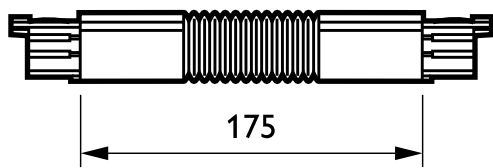

### Productgegevens

Coupling piece with suspension set



Power supply connector end left



# 3-fasen rail RCS750

## Productgegevens

Fish plate connection



Flexible coupling/corner piece



External earth coupling/corner piece outer 90°



End piece



## Algemene informatie

Order Code	Full Product Name	Accessoirekleur	Gloeidraadtest	Gloeidraadtest
8711559798554	ZRS750 CPF BK (XTS23-2)	Zwart	-	-
8711559141558	ZRS750 CPS BK (XTS14-2)	Zwart	-	-
8711559381305	ZRS750 TCPR WH (XTS36-3)	Wit	-	-
8711559141527	ZRS750 CCPE BK (XTS35-2)	Zwart	-	-
8711559141534	ZRS750 CCPI BK (XTS34-2)	Zwart	-	-
8711559149806	RBS750 3C L2000 WH (XTSF4200-3)	Wit	Temperatuur 850 °C, duur 5 s	Temperatuur 850 °C, duur 5 s
8711559149820	RBS750 3C L3000 WH (XTSF4300-3)	Wit	Temperatuur 850 °C, duur 5 s	Temperatuur 850 °C, duur 5 s
8711559381206	ZRS750 CPF WH (XTS23-3)	Wit	-	-
8711559141497	ZRS750 EPSR BK (XTS11-2+41-2)	Zwart	-	-

Order Code	Full Product Name	Accessoirekleur	Gloeidraadtest	Gloeidraadtest
8711559381107	RCS750 3C L1000 WH (XTS4100-3)	Wit	Temperatuur 850 °C, duur 5 s	Temperatuur 850 °C, duur 5 s
8711559381114	RCS750 3C L2000 WH (XTS4200-3)	Wit	Temperatuur 850 °C, duur 5 s	Temperatuur 850 °C, duur 5 s
8711559381121	RCS750 3C L3000 WH (XTS4300-3)	Wit	Temperatuur 850 °C, duur 5 s	Temperatuur 850 °C, duur 5 s
8711559381138	RCS750 3C L4000 WH (XTS4400-3)	Wit	Temperatuur 850 °C, duur 5 s	Temperatuur 850 °C, duur 5 s
8711559141480	ZRS750 EPSL BK (XTS12-2+41-2)	Zwart	-	-
8711559381220	ZRS750 CPS WH (XTS14-3)	Wit	-	-
8711559381268	ZRS750 CCPI WH (XTS34-3)	Wit	-	-
8711559381343	ZRS750 CPX WH (XTS38-3)	Wit	-	-
8711559141503	ZRS750 EP BK (XTS41-2)	Zwart	-	-



## 3-fasen rail RCS750

Order Code	Full Product			
	Name	Accessoirekleur	Gloeidraadtest	Gloeidraadtest
8711559381244	ZRS750 EP WH (XTS41-3)	Wit	-	-
8711559381060	RCS750 3C L1000 ALU (XTS4100-1)	Aluminium	Temperatuur 850 °C, duur 5 s	Temperatuur 850 °C, duur 5 s
8711559381077	RCS750 3C L2000 ALU (XTS4200-1)	Aluminium	Temperatuur 850 °C, duur 5 s	Temperatuur 850 °C, duur 5 s
8711559381084	RCS750 3C L3000 ALU (XTS4300-1)	Aluminium	Temperatuur 850 °C, duur 5 s	Temperatuur 850 °C, duur 5 s
8711559381091	RCS750 3C L4000 ALU (XTS4400-1)	Aluminium	Temperatuur 850 °C, duur 5 s	Temperatuur 850 °C, duur 5 s
8711559381183	ZRS750 ICP WH (XTS21-3)	Wit	-	-
8711559381329	ZRS750 TCPL WH (XTS39-3)	Wit	-	-
8711559149844	ZRS750 CS WH (XTSP11-3)	Wit	-	-
8711559381367	ZRS750 ACP WH (XTS24-3)	Wit	-	-
8711559149790	RBS750 3C L2000 ALU (XTSF4200-1)	Aluminium	Temperatuur 850 °C, duur 5 s	Temperatuur 850 °C, duur 5 s
8711559149813	RBS750 3C L3000 ALU (XTSF4300-1)	Aluminium	Temperatuur 850 °C, duur 5 s	Temperatuur 850 °C, duur 5 s
8711559147154	ZRS750 3C BA WH (GA70-3)	Wit	-	-
8711559381282	ZRS750 CCPE WH (XTS35-3)	Wit	-	-

Order Code	Full Product			
	Name	Accessoirekleur	Gloeidraadtest	Gloeidraadtest
8711559381169	ZRS750 EPSL WH (XTS12-3+41-3)	Wit	-	-
8711559141541	ZRS750 TCPR BK (XTS36-2)	Zwart	-	-
8711559325309	ZRS700 SPCL ALU SUSP CLAMP L (SKB18-1)	Aluminium	-	-
8711559798516	RCS750 3C L1000 BK (XTS4100-2)	Zwart	Temperatuur 850 °C, duur 5 s	Temperatuur 850 °C, duur 5 s
8711559798523	RCS750 3C L2000 BK (XTS4200-2)	Zwart	Temperatuur 850 °C, duur 5 s	Temperatuur 850 °C, duur 5 s
8711559798530	RCS750 3C L3000 BK (XTS4300-2)	Zwart	Temperatuur 850 °C, duur 5 s	Temperatuur 850 °C, duur 5 s
8711559798547	RCS750 3C L4000 BK (XTS4400-2)	Zwart	Temperatuur 850 °C, duur 5 s	Temperatuur 850 °C, duur 5 s
8718696067444	ZCS750 5C6 CPF BK (XTSC623-2)	Zwart	-	-
8711559378817	ZRS700 MBW6 ALU WALL BRACKET (SKB21-1)	Aluminium	-	-
8711559141510	ZRS750 ICP BK (XTS21-2)	Zwart	-	-

### Bedrijfs- en elektrische gegevens

Order Code	Full Product Name	Ingangsspanning	Ingangsspanning
8711559798554	ZRS750 CPF BK (XTS23-2)	250 V	250 V
8711559141558	ZRS750 CPS BK (XTS14-2)	250 V	250 V
8711559381305	ZRS750 TCPR WH (XTS36-3)	-	-
8711559141527	ZRS750 CCPE BK (XTS35-2)	-	-
8711559141534	ZRS750 CCPI BK (XTS34-2)	-	-
8711559149806	RBS750 3C L2000 WH (XTSF4200-3)	-	-
8711559149820	RBS750 3C L3000 WH (XTSF4300-3)	-	-
8711559381206	ZRS750 CPF WH (XTS23-3)	-	-
8711559141497	ZRS750 EPSR BK (XTS11-2+41-2)	250 V	250 V
8711559381107	RCS750 3C L1000 WH (XTS4100-3)	-	-
8711559381114	RCS750 3C L2000 WH (XTS4200-3)	-	-

Order Code	Full Product Name	Ingangsspanning	Ingangsspanning
8711559381121	RCS750 3C L3000 WH (XTS4300-3)	-	-
8711559381138	RCS750 3C L4000 WH (XTS4400-3)	-	-
8711559141480	ZRS750 EPSL BK (XTS12-2+41-2)	250 V	250 V
8711559381220	ZRS750 CPS WH (XTS14-3)	250 V	250 V
8711559381268	ZRS750 CCPI WH (XTS34-3)	-	-
8711559381343	ZRS750 CPX WH (XTS38-3)	-	-
8711559141503	ZRS750 EP BK (XTS41-2)	-	-
8711559381244	ZRS750 EP WH (XTS41-3)	-	-
8711559381060	RCS750 3C L1000 ALU (XTS4100-1)	-	-
8711559381077	RCS750 3C L2000 ALU (XTS4200-1)	-	-

### 3-fasen rail RCS750

Order Code	Full Product Name	Ingangsspanning	Ingangsspanning	Order Code	Full Product Name	Ingangsspanning	Ingangsspanning
8711559381084	RCS750 3C L3000 ALU (XTS4300-1)	-	-	8711559325309	ZRS700 SPCL ALU SUSP CLAMP L (SKB18-1)	-	-
8711559381091	RCS750 3C L4000 ALU (XTS4400-1)	-	-	8711559798516	RCS750 3C L1000 BK (XTS4100-2)	-	-
8711559381183	ZRS750 ICP WH (XTS21-3)	-	-	8711559798523	RCS750 3C L2000 BK (XTS4200-2)	-	-
8711559381329	ZRS750 TCPL WH (XTS39-3)	-	-	8711559798530	RCS750 3C L3000 BK (XTS4300-2)	-	-
8711559149844	ZRS750 CS WH (XTP11-3)	-	-	8711559798547	RCS750 3C L4000 BK (XTS4400-2)	-	-
8711559381367	ZRS750 ACP WH (XTS24-3)	-	-	8718696067444	ZCS750 5C6 CPF BK (XTSC623-2)	-	-
8711559149790	RBS750 3C L2000 ALU (XTSF4200-1)	-	-	8711559378817	ZRS700 MBW6 ALU WALL BRACKET (SKB21-1)	-	-
8711559149813	RBS750 3C L3000 ALU (XTSF4300-1)	-	-	8711559141510	ZRS750 ICP BK (XTS21-2)	250 V	250 V
8711559147154	ZRS750 3C BA WH (GA70-3)	250 V	250 V				
8711559381282	ZRS750 CCPE WH (XTS35-3)	-	-				
8711559381169	ZRS750 EPSL WH (XTS12-3+41-3)	250 V	250 V				
8711559141541	ZRS750 TCPR BK (XTS36-2)	-	-				

### Keurmerken en classificaties

Order Code	Full Product Name	Beschermingsklasse IEC	Beschermingsklasse IEC	Beschermingsklasse IEC	Order Code	Full Product Name	Beschermingsklasse IEC	Beschermingsklasse IEC	Beschermingsklasse IEC
8711559798554	ZRS750 CPF BK (XTS23-2)	-	-	-	8711559381138	RCS750 3C L4000 WH (XTS4400-3)	Veiligheidsklasse I	Veiligheidsklasse I	IP 30
8711559141558	ZRS750 CPS BK (XTS14-2)	-	-	-	8711559141480	ZRS750 EPSL BK (XTS12-2+41-2)	-	-	-
8711559381305	ZRS750 TCPR WH (XTS36-3)	-	-	-	8711559381220	ZRS750 CPS WH (XTS14-3)	-	-	-
8711559141527	ZRS750 CCPE BK (XTS35-2)	-	-	-	8711559381268	ZRS750 CCPI WH (XTS34-3)	-	-	-
8711559141534	ZRS750 CCPI BK (XTS34-2)	-	-	-	8711559381343	ZRS750 CPX WH (XTS38-3)	-	-	-
8711559149806	RBS750 3C L2000 WH (XTSF4200-3)	Veiligheidsklasse I	Veiligheidsklasse I	IP 30	8711559141503	ZRS750 EP BK (XTS41-2)	-	-	-
8711559149820	RBS750 3C L3000 WH (XTSF4300-3)	Veiligheidsklasse I	Veiligheidsklasse I	IP 30	8711559381244	ZRS750 EP WH (XTS41-3)	-	-	-
8711559381206	ZRS750 CPF WH (XTS23-3)	-	-	-	8711559381060	RCS750 3C L1000 ALU (XTS4100-1)	Veiligheidsklasse I	Veiligheidsklasse I	IP 30
8711559141497	ZRS750 EPSR BK (XTS11-2+41-2)	-	-	-	8711559381077	RCS750 3C L2000 ALU (XTS4200-1)	Veiligheidsklasse I	Veiligheidsklasse I	IP 30
8711559381107	RCS750 3C L1000 WH (XTS4100-3)	Veiligheidsklasse I	Veiligheidsklasse I	IP 30	8711559381084	RCS750 3C L3000 ALU (XTS4300-1)	Veiligheidsklasse I	Veiligheidsklasse I	IP 30
8711559381114	RCS750 3C L2000 WH (XTS4200-3)	Veiligheidsklasse I	Veiligheidsklasse I	IP 30	8711559381091	RCS750 3C L4000 ALU (XTS4400-1)	Veiligheidsklasse I	Veiligheidsklasse I	IP 30
8711559381121	RCS750 3C L3000 WH (XTS4300-3)	Veiligheidsklasse I	Veiligheidsklasse I	IP 30	8711559381183	ZRS750 ICP WH (XTS21-3)	-	-	-

### 3-fasen rail RCS750

Order Code	Full Product Name	Beschermingsklasse IEC	Beschermingsklasse IEC	Beschermingsklasse	Order Code	Full Product Name	Beschermingsklasse IEC	Beschermingsklasse IEC	Beschermingsklasse
8711559381329	ZRS750 TCPL WH (XTS39-3)	-	-	-	-	CLAMP L (SKB18-1)	-	-	-
8711559149844	ZRS750 CS WH (XTSP11-3)	-	-	-	8711559798516	RCS750 3C L1000 BK (XTS4100-2)	Veiligheidsklasse I	Veiligheidsklasse I	IP 30
8711559381367	ZRS750 ACP WH (XTS24-3)	-	-	-	8711559798523	RCS750 3C	Veiligheidsklasse I	Veiligheidsklasse I	IP 30
8711559149790	RBS750 3C L2000 ALU (XTSF4200-1)	Veiligheidsklasse I	Veiligheidsklasse I	IP 30	IP 30	L2000 BK (XTS4200-2)	-	-	-
8711559149813	RBS750 3C L3000 ALU (XTSF4300-1)	Veiligheidsklasse I	Veiligheidsklasse I	IP 30	IP 30	RCS750 3C	Veiligheidsklasse I	Veiligheidsklasse I	IP 30
8711559147154	ZRS750 3C BA WH (GA70-3)	-	-	-	8711559798547	RCS750 3C	Veiligheidsklasse I	Veiligheidsklasse I	IP 30
8711559381282	ZRS750 CCPE WH (XTS35-3)	-	-	-	8718696067444	ZCS750 5C6 CPF BK (XTSC623-2)	-	-	-
8711559381169	ZRS750 EPSL WH (XTS12-3+41-3)	-	-	-	8711559378817	ZRS700 MBW6 ALU	-	-	-
8711559141541	ZRS750 TCPR BK (XTS36-2)	-	-	-	-	WALL BRACKET	-	-	-
8711559325309	ZRS700 SPCL ALU SUSP	-	-	-	-	(SKB21-1)	-	-	-
					8711559141510	ZRS750 ICP BK (XTS21-2)	-	-	-

