



Apparecchio lineare R7S a tensione di rete con emissione luminosa molto elevata

CorePro LEDlinear MV

CorePro R7S è una sostituzione retrofit per le lampade lineari a terminazione doppia R7S. Il design per una "luce completamente diffusa" offre un'illuminazione analoga a quella delle lampade alogene. All'interno della gamma è possibile scegliere prodotti dimmerabili che hanno la funzione avanzata di regolazione del flusso che consente di creare un'atmosfera accogliente quando si usa un apparecchio regolabile.

Vantaggi

- Risparmio energetico fino all'90% rispetto alle lampade alogene standard
- Minori costi di manutenzione

Caratteristiche

- Facilità di aggiornamento diretto (retrofit)
- Funziona a 220-240 V CA e il suo fattore di forma è progettato come aggiornamento diretto (retrofit) in tutti gli attacchi a terminazione doppia
- Durata di 15.000 ore (B50L70)
- Luce priva di raggi UV e IR
- Priva di mercurio e materiali pericolosi – Conforme alla direttiva RoHS

Applicazione

- Soggiorni, corridoi, illuminazione da esterni (lampade di emergenza), apparecchi a piantana per interni, illuminazioni per cantieri edili

CorePro LEDlinear MV

Versions

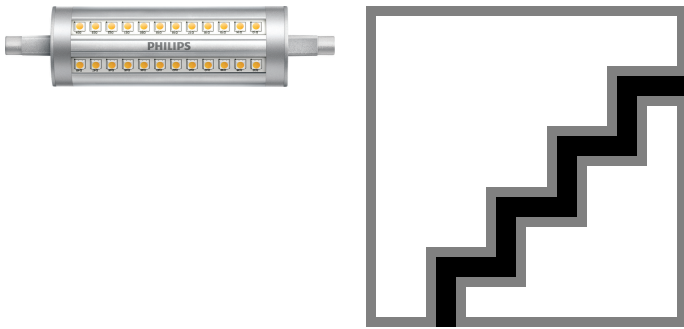

Disegno tecnico

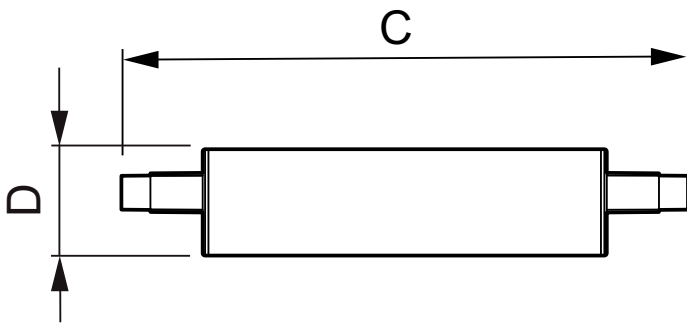

Product	D	C
CorePro LED linear R7S 118mm 6.5-60W 830	22,5 mm	118 mm
CorePro LED linear R7S 118mm 14-100W 840 D	29 mm	118 mm
CorePro LED linear R7S 118mm 14-100W 830 D	29 mm	118 mm
CoreProLED linearD 17.5-150W R7S 118 840	42 mm	118 mm
CorePro LED linear D 14-120W R7S 118 830	29 mm	118 mm
CorePro LED linear D 14-120W R7S 118 840	29 mm	118 mm
CoreProLED linearD 17.5-150W R7S 118 830	42 mm	118 mm

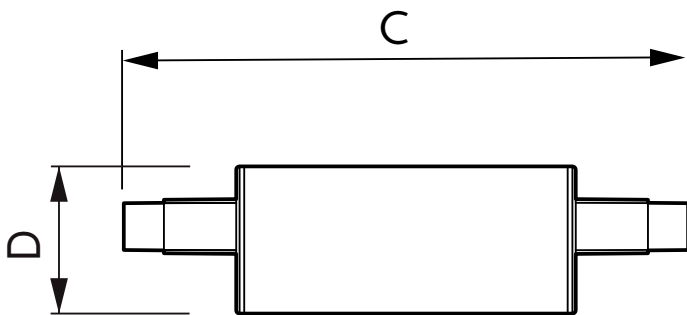

Product	D	C
CorePro LEDlinear ND 7.5-60W R7S 78mm840	29 mm	78 mm
CorePro LEDlinear ND 7.5-60W R7S 78mm830	29 mm	78 mm

CorePro LEDlinear MV

Funzionamento e parte elettrica

Frequenza di ingresso	Da 50 a 60 Hz
Tensione (Nom)	220-240 V
Tempo di avvio (Nom)	0,5 s

Informazioni generali

Attacco	R7S
Ciclo di commutazione on/off	50.000 X

Dati tecnici di illuminazione

Indice di resa dei colori (Nom)	80
LLMF a fine durata nominale (Nom)	70 %

Approvazione e applicazione

Order Code	Full Product Name	Consumo energetico kWh/1000 h	Marchio di efficienza energetica (EEL)
52253000	CorePro LED linear R7S 118mm 6.5-60W 830	7 kWh	A++
57879700	CorePro LED linear R7S 118mm 14-100W 830 D	14 kWh	A+
57881000	CorePro LED linear R7S 118mm 14-100W 840 D	14 kWh	A++
71394500	CorePro LEDlinear ND 7.5-60W R7S 78mm830	8 kWh	A++
71396900	CorePro LEDlinear ND 7.5-60W R7S 78mm840	8 kWh	A++

Order Code	Full Product Name	Consumo energetico kWh/1000 h	Marchio di efficienza energetica (EEL)
71400300	CorePro LED linear D 14-120W R7S 118 830	14 kWh	A++
71406500	CorePro LED linear D 14-120W R7S 118 840	14 kWh	A++
64673800	CoreProLED linearD 17.5-150W R7S 118 830	18 kWh	A++
64675200	CoreProLED linearD 17.5-150W R7S 118 840	18 kWh	A++

Controlli e regolazione del flusso

Order Code	Full Product Name	Regolabile
52253000	CorePro LED linear R7S 118mm 6.5-60W 830	No
57879700	CorePro LED linear R7S 118mm 14-100W 830 D	Si
57881000	CorePro LED linear R7S 118mm 14-100W 840 D	Si
71394500	CorePro LEDlinear ND 7.5-60W R7S 78mm830	No
71396900	CorePro LEDlinear ND 7.5-60W R7S 78mm840	No

Order Code	Full Product Name	Regolabile
71400300	CorePro LED linear D 14-120W R7S 118 830	Si
71406500	CorePro LED linear D 14-120W R7S 118 840	Si
64673800	CoreProLED linearD 17.5-150W R7S 118 830	Si
64675200	CoreProLED linearD 17.5-150W R7S 118 840	Si

Funzionamento e parte elettrica

Order Code	Full Product Name	Potenza (Specificata) (Nom)
52253000	CorePro LED linear R7S 118mm 6.5-60W 830	6.5 W
57879700	CorePro LED linear R7S 118mm 14-100W 830 D	14 W
57881000	CorePro LED linear R7S 118mm 14-100W 840 D	14 W
71394500	CorePro LEDlinear ND 7.5-60W R7S 78mm830	7.5 W
71396900	CorePro LEDlinear ND 7.5-60W R7S 78mm840	7.5 W

Order Code	Full Product Name	Potenza (Specificata) (Nom)
71400300	CorePro LED linear D 14-120W R7S 118 830	14 W
71406500	CorePro LED linear D 14-120W R7S 118 840	14 W
64673800	CoreProLED linearD 17.5-150W R7S 118 830	17.5 W
64675200	CoreProLED linearD 17.5-150W R7S 118 840	17.5 W

Informazioni generali

CorePro LEDlinear MV

Order Code	Full Product Name	Durata nominale (Nom)	Durata specificata (ore)
52253000	CorePro LED linear R7S 118mm 6.5-60W 830	20000 h	20000 h
57879700	CorePro LED linear R7S 118mm 14-100W 830 D	15000 h	15000 h
57881000	CorePro LED linear R7S 118mm 14-100W 840 D	15000 h	15000 h
71394500	CorePro LEDlinear ND 7.5-60W R7S 78mm830	15000 h	15000 h
71396900	CorePro LEDlinear ND 7.5-60W R7S 78mm840	15000 h	15000 h

Order Code	Full Product Name	Durata nominale (Nom)	Durata specificata (ore)
71400300	CorePro LED linear D 14-120W R7S 118 830	15000 h	15000 h
71406500	CorePro LED linear D 14-120W R7S 118 840	15000 h	15000 h
64673800	CoreProLED linearD 17.5-150W R7S 118 830	15000 h	15000 h
64675200	CoreProLED linearD 17.5-150W R7S 118 840	15000 h	15000 h

Dati tecnici di illuminazione

Order Code	Full Product Name	Angolo del fascio (Nom)	Codice colore	Temperatura di colore correlata (Nom)	Distribuzione della luce	Flusso luminoso (Nom)	Flusso luminoso (specificato) (Nom)	Angolo del fascio specificato
52253000	CorePro LED linear R7S 118mm 6.5-60W 830	300 °	830	3000 K	-	806 lm	806 lm	300 °
57879700	CorePro LED linear R7S 118mm 14-100W 830 D	-	830	3000 K	-	1600 lm	1600 lm	-
57881000	CorePro LED linear R7S 118mm 14-100W 840 D	-	840	4000 K	-	1800 lm	1800 lm	-
71394500	CorePro LEDlinear ND 7.5-60W R7S 78mm830	-	830	3000 K	-	950 lm	950 lm	-
71396900	CorePro LEDlinear ND 7.5-60W R7S 78mm840	-	840	4000 K	-	1000 lm	1000 lm	-
71400300	CorePro LED linear D 14-120W R7S 118 830	-	830	3000 K	-	2000 lm	2000 lm	-
71406500	CorePro LED linear D 14-120W R7S 118 840	-	840	4000 K	-	2000 lm	2000 lm	-
64673800	CoreProLED linearD 17.5-150W R7S 118 830	-	830	3000 K	-	2460 lm	2460 lm	-
64675200	CoreProLED linearD 17.5-150W R7S 118 840	-	840	4000 K	-	2460 lm	2460 lm	-

Meccanica e corpo

Order Code	Full Product Name	Finitura lampadina	Forma lampadina	Order Code	Full Product Name	Finitura lampadina	Forma lampadina
52253000	CorePro LED linear R7S 118mm 6.5-60W 830	Chiara (CL)	Lineare	71400300	CorePro LED linear D 14-120W R7S 118 830	-	Lineare
57879700	CorePro LED linear R7S 118mm 14-100W 830 D	-	Lineare	71406500	CorePro LED linear D 14-120W R7S 118 840	-	Lineare
57881000	CorePro LED linear R7S 118mm 14-100W 840 D	-	Lineare	64673800	CoreProLED linearD 17.5-150W R7S 118 830	-	Lineare
71394500	CorePro LEDlinear ND 7.5-60W R7S 78mm830	-	Altro	64675200	CoreProLED linearD 17.5-150W R7S 118 840	-	Lineare
71396900	CorePro LEDlinear ND 7.5-60W R7S 78mm840	-	Altro				

Temperatura

CorePro LEDlinear MV

Order Code	Full Product Name	Temp. massima involucro (Nom)
52253000	CorePro LED linear R7S 118mm 6.5-60W 830	-
57879700	CorePro LED linear R7S 118mm 14-100W 830 D 90 °C	90 °C
57881000	CorePro LED linear R7S 118mm 14-100W 840 D 90 °C	90 °C
71394500	CorePro LEDlinear ND 7.5-60W R7S 78mm830	104 °C
71396900	CorePro LEDlinear ND 7.5-60W R7S 78mm840	104 °C
71400300	CorePro LED linear D 14-120W R7S 118 830	100 °C
71406500	CorePro LED linear D 14-120W R7S 118 840	100 °C
64673800	CoreProLED linearD 17.5-150W R7S 118 830	102 °C
64675200	CoreProLED linearD 17.5-150W R7S 118 840	102 °C

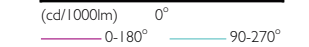
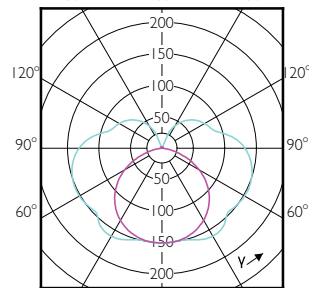
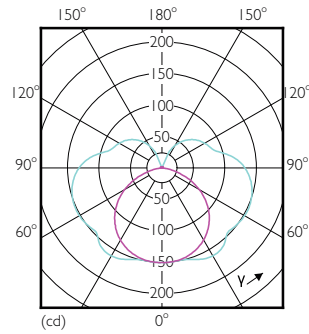
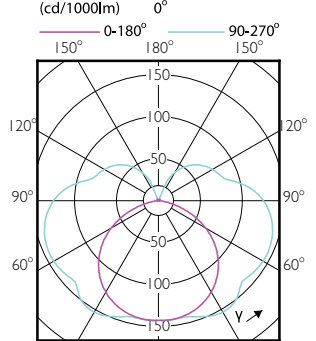
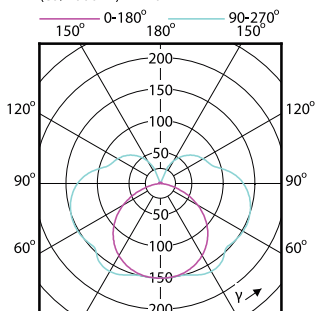
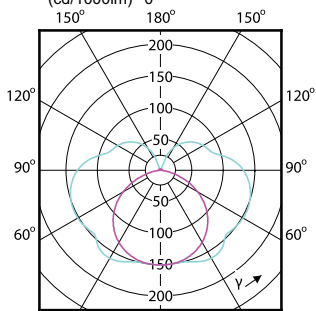
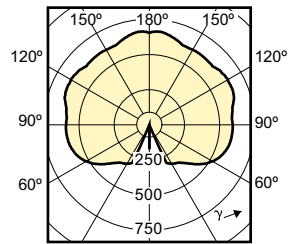

CorePro LEDlinear MV

Accent Diagrams

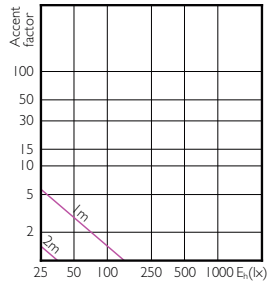

CorePro LEDlinear MV 60W R7S 830 Linear

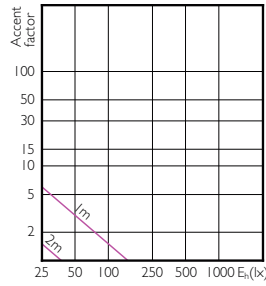

CorePro LEDlinear MV 60W R7S 840 Linear

Beam Diagrams

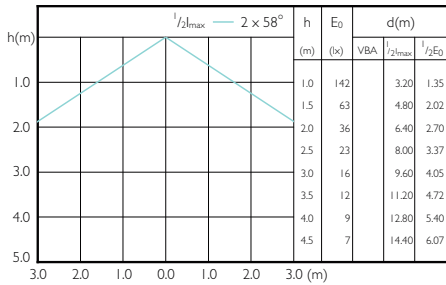

CorePro LEDlinear MV 60W R7S 830 Linear

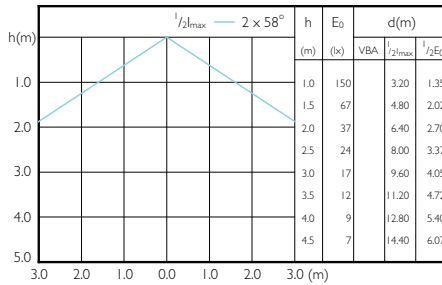

CorePro LEDlinear MV 60W R7S 840 Linear

