

Project: _____

Location: _____

Cat.No: _____

Type: _____

Lamps: _____ Qty: _____

Notes: _____

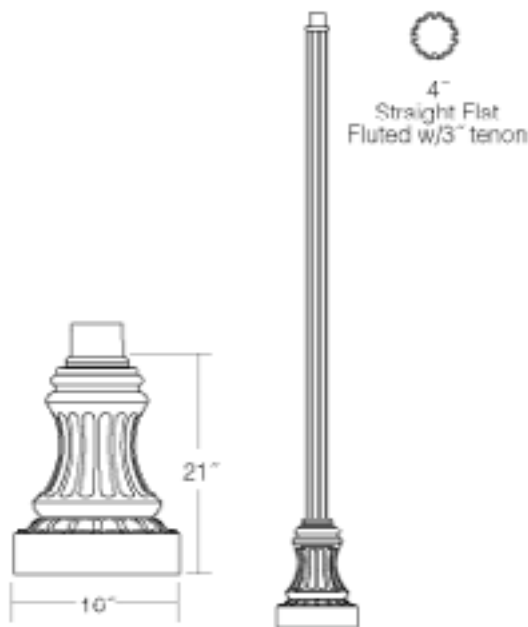

Ordering Guide

Example: P2063 10 A T D

Product Code	P2063	
Pole Height	10	10'
	12	12'
	14	14'
	16	16'
Finish	A	Black
	B	White
	G	Verde
	H	Bronze
	J	Green
Outlet Location (Optional)	T	12" Down from Top - Aligned with House Side
	B	4" Up from Top of Base - Aligned with House Side
Outlet Options (Optional)	D	Standard Duplex
	G	GFI Duplex

Specifications

HOUSING:

356 HM high-strength, low-copper, proprietary cast aluminum alloy . 6005-T5 extruded aluminum. Anchor rods are hot dipped galvanized steel . Tenon is 356 HM sand cast aluminum.

FINISH:

A durable polyurethane enamel finish is applied after assemblies are shot blasted to create a surface profile which allows for the highest level of paint adhesion. Laboratory tested for superior weatherability and fade resistance in accordance with ASTM B-117-64 and ANSI/ASTM G53-77 specifications. For larger projects where a custom color is required, contact the factory for more information.

WARRANTY:

Three-year limited warranty.

OUTLET:

Standard Duplex Outlet has universal metal weatherproof cover. Weatherproof while in use. Heavy-duty all-metal construction. Lockable security cover. Meets NEC 406.9 (B). Weather resistant. GFI Duplex Outlet has dual-function indicator light, universal metal weatherproof cover. Weatherproof while in use. Heavy-duty all-metal construction. Lockable security cover. Meets NEC 406.9 (B). Weather resistant.

P2063 P2063

Pole

Specifications

Tenon/Top:

3" OD

Bolt Circle:

8" - 12"

Anchor Rods:

(4) 3/4" dia. x 19"

Base Dimensions:

16 dia. x 21"

Hand Hole :

5" x 8"

Shaft:

4" Straight Flat Fluted

Wall Thickness:

0.188 - 0.313 Aluminum

Height :

10', 12', 14', 16'

Pole EPA Values

Windspeed(mph)	Height			
	10'	12'	14'	16'
80	19.1900	15.9600	10.8500	8.8400
100	11.2900	9.2300	6.1600	4.6900

