



CityCharm Cone

BDS491 GRN70-/740 II DM GRB GR C4K 60

CityCharm Cone - LED GreenLine 7000 lm - Distribution medium - Spigot for diameter 60 mm

CityCharm Cone is designed for use in urban areas where comfortable lighting, ambiance and design play an important role. Its unobtrusive appearance makes it a timeless, future-proof luminaire that is ideal for residential areas, parks, footpaths and cycle lanes, where visual comfort and maximum efficiency are key. CityCharm offers a choice of two iconic designs (Cone and Cordoba) and various accessories, enabling you to create a lighting solution that carries your signature, both by day and by night. CityCharm luminaires are also available as a complete set, with a choice of dedicated poles and brackets.

Product data

General Information			
Number of light sources	40 [40 pcs]	Light regulation	-
Lamp family code	GRN70 [LED GreenLine 7000 lm]	Electrical circuit protection	-
Light source colour	740 neutral white	Connection	Flying leads/wires
Light source replaceable	Yes	Cable	Cable 4.0 m without plug
Number of gear units	1 unit	Protection class IEC	Safety class II (II)
Gear	EB [Electronic]	Coating	-
Driver/power unit/transformer	PSR [Power supply unit regulating]	Glow-wire test	650/30 [Temperature 650 °C, duration 30 s]
Driver included	Yes	Flammability mark	NO [-]
Decorative spill light	Gray bowl	CE mark	CE mark
Optical element	No [-]	ENEC mark	ENEC mark
Optical cover/lens type	PC [Polycarbonate bowl/cover]	Warranty period	5 years
Luminaire light beam spread	360°	Outdoor optic type	Distribution medium
Embedded control	No [-]	Remarks	* At extreme ambient temperatures the luminaire might automatically dim down to protect components
Control interface	-		

CityCharm Cone

Constant light output	No
Spare parts available	Yes
Number of products on MCB	11
Photobiological risk	Risk group 1
Product recyclability	56%
WEEE mark	WEEE mark
LED engine type	LED
Product Family Code	BDS491 [CityCharm Cone]

Light Technical

Upward light output ratio	0.03
Initial luminous flux at 15°C	7000 lm
Initial luminous flux at 25°C	7000 lm
Initial luminous flux at 35°C	7000 lm
Standard tilt angle post-top	0°
Standard tilt angle side entry	0°

Operating and Electrical

Input voltage	220 to 240 V
Input frequency	50 to 60 Hz
Inrush current	80 A
Inrush time	15 ms
Driver current	405 mA
Power factor (min.)	0.8
Power factor (nom.)	0.9

Controls and Dimming

Dimmable	No
----------	----

Mechanical and Housing

Housing material	Aluminum
Reflector material	-
Optic material	Polycarbonate
Optical cover/lens material	Polycarbonate
Fixation material	Aluminum
Mounting device	60 [Spigot for diameter 60 mm]
Optical cover/lens shape	Hemispherical
Optical cover/lens finish	Clear
Torque	25

Overall height	529 mm
Overall diameter	556 mm
Effective projected area	0.1155 m ²
Colour	Gray
Dimensions (height x width x depth)	529 x NaN x NaN mm (20.8 x NaN x NaN in)

Approval and Application

Ingress protection code	IP66 [Dust penetration-protected, jet-proof]
Mech. impact protection code	IK10 [20 J vandal-resistant]
Surge protection (common/differential)	Luminaire surge protection level up to 6 kV differential mode and 8 kV common mode

Initial Performance (IEC Compliant)

Initial luminous flux	5266 lm
Luminous flux tolerance	+/-10%
Initial LED luminaire efficacy	112 lm/W
Init. Corr. colour temperature	4000 K
Init. colour rendering index	≥70
Initial chromaticity	(0.380, 0.370) SDCM <3
Initial input power	47 W
Power consumption tolerance	+/-10%

Application Conditions

Ambient temperature range	-40 to +50 °C
Maximum dimming level	Not applicable

Product Data

Full product code	871869692124100
Order product name	BDS491 GRN70-/740 II DM GRB GR C4K 60
EAN/UPC – product	8718696921241
Order code	92124100
Numerator – quantity per pack	1
Numerator – packs per outer box	1
Material no. (12NC)	910505017140
Net weight (piece)	12.000 kg

CityCharm Cone

Dimensional drawing

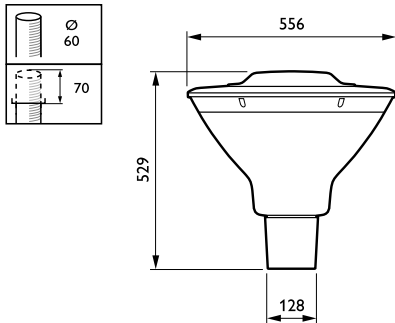

CityCharm BDS490/491

