



LumiStreet

BGP214 LED139-4S/740 I DM50 D9 48/60A

LumiStreet Large - LED module 13900 lm - 740 neutral white - Safety class I (I) - Distribution medium - - - Universal for diameter 48-60 mm adjustable

Many local authorities today have an outdated public lighting installation that urgently needs to be replaced, yet have only a limited budget available. We have the answer to their needs. With its compact design and modern LED architecture, LumiStreet is a versatile, cost-effective luminaire that fulfils basic functional road lighting requirements. It is made of high-quality components that ensure long lifetime and low maintenance cost. The result? A road lighting luminaire that provides effective illumination while at the same time cutting energy and maintenance bills.

Product data

General Information		CE mark	CE mark
Lamp family code	LED139 [LED module 13900 lm]	ENEC mark	ENEC mark
Light source colour	740 neutral white	Warranty period	5 years
Light source replaceable	Yes	Outdoor optic type	Distribution medium
Number of gear units	1 unit	Remarks	* At extreme ambient temperatures the luminaire might automatically dim down to protect components
Driver/power unit/transformer	PSD [Power supply unit with DALI interface]	Constant light output	No
Driver included	Yes	Number of products on MCB	8
Optical cover/lens type	FG [Flat glass]	LED engine type	LED
Luminaire light beam spread	154° - 31° x 54°	Product Family Code	BGP214 [LumiStreet Large]
Control interface	DALI	Light Technical	
Connection	SI [Screw connection block]	Upward light output ratio	0
Cable	-		
Protection class IEC	Safety class I (I)		
Flammability mark	NO [-]		

Standard tilt angle post-top	0°
Standard tilt angle side entry	0°

Operating and Electrical

Input voltage	220-240 V
Input frequency	50 to 60 Hz
Initial CLO power consumption	0 W
Average CLO power consumption	[DELETE] W
End CLO power consumption	[DELETE] W
Inrush current	53 A
Inrush time	0.3 ms
Power factor (min.)	0.97

Controls and Dimming

Dimmable	Yes
----------	-----

Mechanical and Housing

Housing material	Aluminum die-cast
Reflector material	Polycarbonate
Optic material	Polycarbonate
Optical cover/lens material	Tempered glass
Fixation material	Aluminium
Mounting device	48/60A [Universal for diameter 48-60 mm adjustable]
Optical cover/lens shape	Flat
Optical cover/lens finish	Clear
Overall length	755 mm
Overall width	355 mm
Overall height	98 mm
Overall diameter	0 mm
Effective projected area	0.04 m ²
Colour	Gray
Dimensions (height x width x depth)	98 x 355 x 755 mm (3.9 x 14 x 29.7 in)

Approval and Application

Ingress protection code	IP66 [Dust penetration-protected, jet-proof]
Mech. impact protection code	IK08 [5 J vandal-protected]
Surge protection (common/differential)	Philips standard surge protection level kV

Initial Performance (IEC Compliant)

Initial luminous flux	12040 lm
Luminous flux tolerance	+/-7%
Initial LED luminaire efficacy	145 lm/W
Init. Corr. colour temperature	4000 K
Init. colour rendering index	70
Initial chromaticity	(0.381, 0.379) SDCM <5
Initial input power	83 W
Power consumption tolerance	+/-11%

Application Conditions

Ambient temperature range	-40 to +50 °C
Maximum dimming level	0% (digital)

Product Data

Full product code	871869634888800
Order product name	BGP214 LED139-4S/740 I DM50 D9 48/60A
EAN/UPC – product	8718696348888
Order code	34888800
Numerator – quantity per pack	1
Numerator – packs per outer box	1
Material no. (12NC)	910925866064
Net weight (piece)	9.000 kg

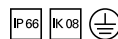

Dimensional drawing

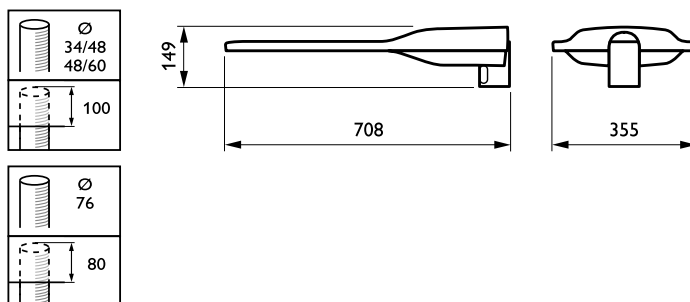

LumiStreet Large BGP/BGS214

