



# UniStreet

## BGP243 LED60-4S/740 II DM11 D9 48/60A

UniStreet Medium - LED module 6000 lm - 740 neutral white - Safety class II - Distribution medium 11 - Flat glass - Side-entry for diameter 48-60 mm

At relatively low initial cost, the highly efficient LED-based UniStreet luminaire offers significant cost savings compared with conventional street lighting, ensuring full payback within a short period of time. Available in a choice of lumen packages, UniStreet allows point-to-point replacement of outdated conventional light sources and luminaires. The compact, slim luminaire is made of quality recyclable materials. And being a LED solution, it requires little maintenance.

### Product data

General Information		Light Technical	
Lamp family code	LED60 [ LED module 6000 lm]	ENEC mark	ENEC mark
Light source colour	740 neutral white	Warranty period	5 years
Light source replaceable	Yes	Outdoor optic type	Distribution medium 11
Number of gear units	1 unit	Remarks	* At extreme ambient temperatures the luminaire might automatically dim down to protect components
Driver/power unit/transformer	PSD [ Power supply unit with DALI interface]	Constant light output	No
Driver included	Yes	Number of products on MCB	11
Optical cover/lens type	FG [ Flat glass]	LED engine type	LED
Luminaire light beam spread	160° - 42° x 54°	Product Family Code	BGP243 [ UniStreet Medium]
Control interface	DALI		
Connection	Connection unit 5-pole		
Cable	-		
Protection class IEC	Safety class II	Upward light output ratio	0
Flammability mark	F [ For mounting on normally flammable surfaces]	Standard tilt angle post-top	0°
CE mark	CE mark	Standard tilt angle side entry	0°

## Operating and Electrical

Input voltage	230 V
Input frequency	50 to 60 Hz
Initial CLO power consumption	0 W
Average CLO power consumption	[DELETE] W
End CLO power consumption	[DELETE] W
Inrush current	46 A
Inrush time	0.25 ms
Power factor (min.)	0.95

## Controls and Dimming

Dimmable	Yes
----------	-----

## Mechanical and Housing

Housing material	Aluminium die-cast
Reflector material	Polycarbonate
Optic material	Polycarbonate
Optical cover/lens material	Polycarbonate
Fixation material	Aluminium
Mounting device	48/60S [ Side-entry for diameter 48-60 mm]
Optical cover/lens shape	Curved
Optical cover/lens finish	Clear
Overall length	580 mm
Overall width	353 mm
Overall height	98 mm
Overall diameter	0 mm
Effective projected area	0.42 m <sup>2</sup>
Colour	Grey
Dimensions (height x width x depth)	98 x 353 x 580 mm (3.9 x 13.9 x 22.8 in)

## Approval and Application

Ingress protection code	IP66 [ Dust penetration-protected, jet-proof]
-------------------------	---

Mech. impact protection code	IK08 [ 5 J vandal-protected]
Surge protection (common/differential)	Philips standard surge protection level kV

## Initial Performance (IEC Compliant)

Initial luminous flux	5340 lm
Luminous flux tolerance	+/-7%
Initial LED luminaire efficacy	148 lm/W
Init. Corr. colour temperature	4000 K
Init. colour rendering index	70
Initial chromaticity	(0.38, 0.38) SDCM <5
Initial input power	36 W
Power consumption tolerance	+/-11%

## Application Conditions

Ambient temperature range	-40 to +50 °C
Maximum dimming level	0% (digital)

## Product Data

Full product code	871869698847300
Order product name	BGP243 LED60-4S/740 II DM11 D9 48/60A
EAN/UPC – product	8718696988473
Order code	98847300
Numerator – quantity per pack	1
Numerator – packs per outer box	1
Material no. (12NC)	910925866101
Net weight (piece)	6.020 kg



## Dimensional drawing

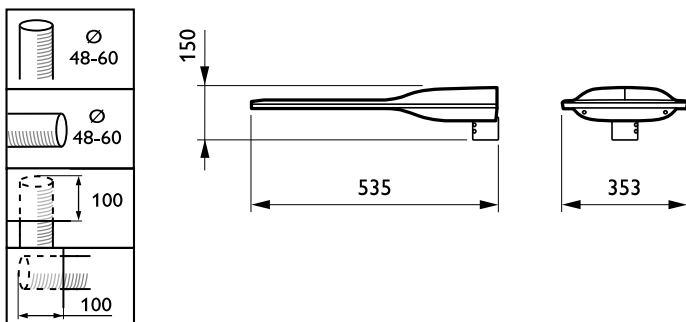

UniStreet Medium BGP/BGS243

