



# OptiVision LED

## BVP510 GRN 93K/757 A-WB T15 LO

OptiVision LED - LED GreenLine - 93,000 lm - 757 cool white - 110 to 277 V - Asymmetrical wide beam - 15 °C - Internal louvre

Philips OptiVision LED floodlighting system – the latest in high-efficiency LED technology – provides a complete lighting solution for the simplest through to the most complex area and recreational sports lighting applications. The specially engineered OptiVision LED luminaires come with a full range of options to meet the highest performance standards, to provide outstanding light quality, and to guarantee safety and visual comfort. They deliver maximum light output while ensuring effective thermal management in order to maximize lifetime and minimize maintenance costs. In area applications, the OptiVision LED system offers new possibilities to reduce energy consumption and increase flexibility (instant start, programmable lighting levels based on actual need) when used in conjunction with Philips’ advanced system controls and sensors. The OptiVision LED luminaires are also compatible with other external control systems via DALI protocol. The range includes versions with three/two LED light modules which function with an external driver box, as well a compact version with two LED light modules and an integral driver unit for easy installation and lower installation costs.

### Product data

General Information	
Lamp family code	GRN [ LED GreenLine]
Light source colour	757 cool white
Light source replaceable	Yes
Driver/power unit/transformer	No [-]
Driver included	No
Optical cover/lens type	PC [ Polycarbonate bowl/cover]
Protection class IEC	Safety class I
Coating	-

CE mark	CE mark
Glare shielding accessories	LO [ Internal louvre]
Outdoor optic type	Asymmetrical wide beam
Remarks	* At extreme ambient temperatures the luminaire might automatically dim down to protect components
Constant light output	No
Product Family Code	BVP510 [ OptiVision LED]

# OptiVision LED

## Light Technical

Light source flux 93,000 lm

## Operating and Electrical

Input voltage 110 to 277 V

Input frequency 50 to 60 Hz

## Controls and Dimming

Dimmable Yes

## Mechanical and Housing

Housing material Aluminium

Optic material Polycarbonate

Optical cover/lens material Polycarbonate

Colour Grey

## Approval and Application

Ingress protection code IP66 [ Dust penetration-protected, jet-proof]

Mech. impact protection code IK08 [ 5 J vandal-protected]

## Initial Performance (IEC Compliant)

Initial luminous flux 93000 lm

Initial LED luminaire efficacy 92 lm/W

Init. Corr. colour temperature 5700 K

Initial input power 1012 W

## Application Conditions

Ambient temperature range -40 to +50 °C

## Product Data

Full product code 871794320144000

Order product name BVP510 GRN 93K/757 A-WB T15 LO

EAN/UPC – product 8717943201440

Order code 20144000

Numerator – quantity per pack 1

Numerator – packs per outer box 1

Material no. (12NC) 912300023177

Net weight (piece) 23.500 kg

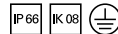

## Dimensional drawing

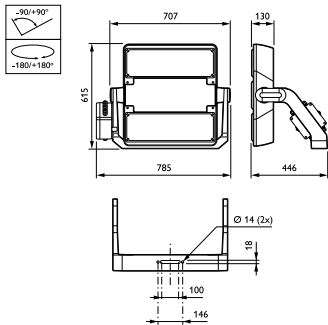

OptiVision LED BVP500/515/520/525

