



# Dynalite User Interface

## PATPE-WC-X

Regardless of the level of integration and range of available functions, a control system requires an intuitive end-user interface, so that users can easily schedule and activate the various control functionalities. Philips Dynalite user interfaces come in a broad range of panels, touchscreens and wiring devices – with a rich variety of styles and finishes to match any project budget, level of interactivity, or décor requirements.

Regardless of the level of integration and range of available functions, a control system requires an intuitive end-user interface, so that users can easily schedule and activate the various control functionalities. Philips Dynalite user interfaces come in a broad range of panels, touchscreens and wiring devices – with a rich variety of styles and finishes to match any project budget, level of interactivity, or décor requirements.

### Product data

General Information	
CE mark	CE mark
Remarks	Please download the Lighting - Product Data Sheet for more information and ordering options
RoHS mark	RoHS mark
Type number	Antumbra touch panel, European style

Product Data	
Full product code	871829168532600
Order product name	PATPE-WC-X
EAN/UPC – product	8718291685326
Order code	68532600
Numerator – quantity per pack	1
Numerator – packs per outer box	1
Material no. (12NC)	913703433107

# Dynalite User Interface

Net weight (piece) 0.084 kg

## Dimensional drawing

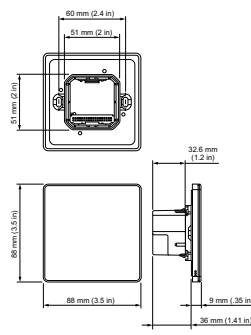
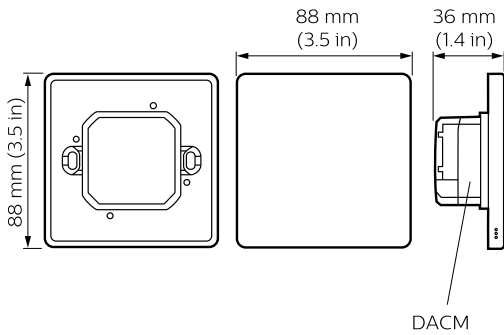

Dynalite User Interfaces

Dynalite User Interfaces

