



Dynalite User Interface

PATPA-WA-X

PATPA AntumbraTouch NA

PATPA AntumbraTouch NA

Product data

General Information	
Type description	WA-X
Remarks	Please download the Lighting - Product Data Sheet for more information and ordering options
RoHS mark	RoHS mark
Type number	PATPA
Product Data	
Full product code	871829170826100

Order product name	PATPA-WA-X
EAN/UPC – product	8718291708261
Order code	70826100
Numerator – quantity per pack	1
Numerator – packs per outer box	1
Material no. (12NC)	913703447307
Net weight (piece)	0.096 kg

Dynalite User Interface

Dimensional drawing

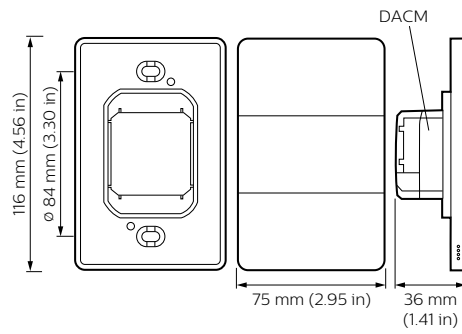
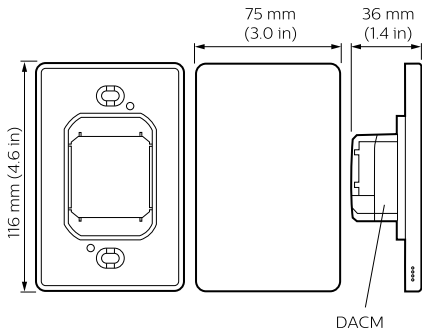

Dynalite User Interfaces

Dynalite User Interfaces

