



MASTER LEDtube EM/ Mains

Master LEDTube 1200 mm 18W 865 T8 I W

The Philips MASTER LEDtube integrates a LED light source into a traditional fluorescent form factor. Its unique design creates a perfectly uniform visual appearance which cannot be distinguished from traditional fluorescent. For those that are looking for value for money within limited budget and re-lamping efforts for better light effect and lifetime.

Product data

General Information	
Cap base	G13 [Medium Bi-Pin Fluorescent]
Nominal lifetime (nom.)	40000 h
Switching cycle	50000X
Light Technical	
Colour code	865 [CCT of 6,500 K]
Beam Angle (Nom)	160 °
Luminous flux (nom.)	2100 lm
Correlated colour temperature (nom.)	6500 K
Colour consistency	<6
Color rendering index (nom.)	82
LLMF at end of nominal lifetime (nom.)	70 %
Operating and Electrical	
Input frequency	50 to 60 Hz
Power (Rated) (Nom)	18 W
Starting time (nom.)	0.5 s
Warm-up time to 60% light (nom.)	instant full light s
Power factor (nom.)	0.92

Voltage (Nom)	100-240 V
Temperature	
T ambient (max.)	45 °C
T ambient (min.)	-20 °C
T storage (max.)	65 °C
T storage (min.)	-40 °C
T-Case maximum (nom.)	70 °C
Controls and Dimming	
Dimmable	No
Mechanical and Housing	
Product length	1200 mm
Approval and Application	
Energy efficiency label (EEL)	A+
Energy-saving product	Yes
Suitable for accent lighting	No

MASTER LEDtube EM/Mains

Approval marks	CE marking RoHS compliance KEMA Keur certificate
Energy Consumption kWh/1000 h	18 kWh
Product Data	
Full product code	871869652406000
Order product name	Master LEDTube 1200 mm 18W 865 T8 I W
EAN/UPC – product	8718696524060

Order code	52406000
Numerator – quantity per pack	1
Numerator – packs per outer box	10
Material no. (12NC)	929001187812
Net weight (piece)	0.230 kg

Warnings and Safety

Dimensional drawing

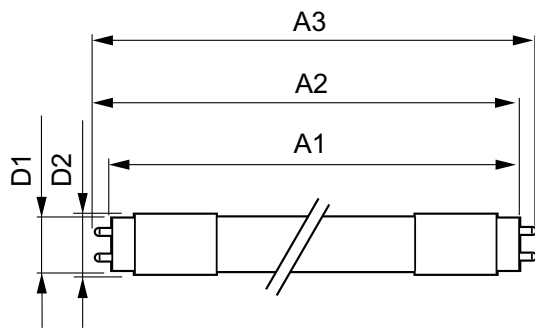

LEDtube 1200mm 18W/865 T8 I W

Product	D1	D2	A1	A2	A3
Master LEDTube 1200 mm 18W 865 T8 I W	25.6 mm	27.8 mm	1198.1 mm	1205.2 mm	1212.3 mm

Photometric data

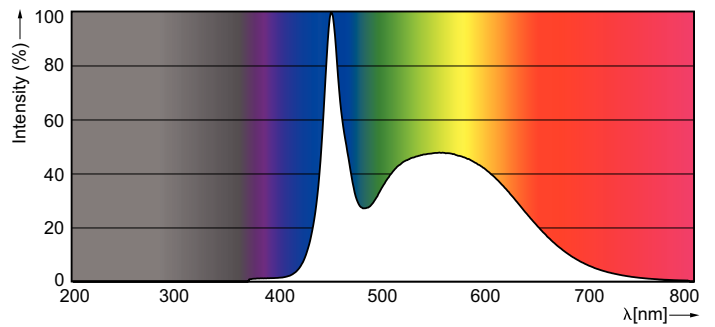
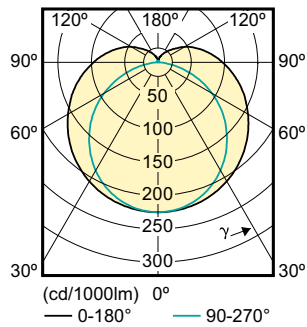

SDPO_MLEDGA_0069-Spectral Power distribution

MASTER LEDtube EM/Mains

Lifetime

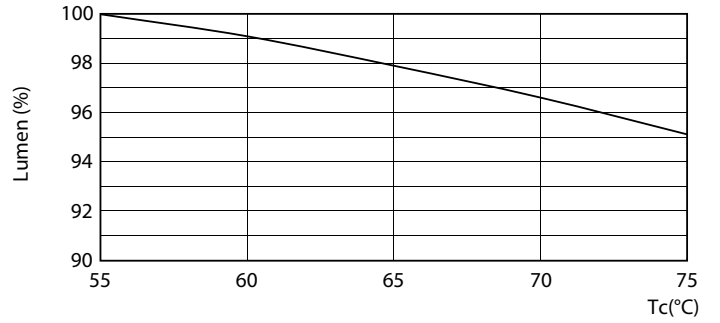
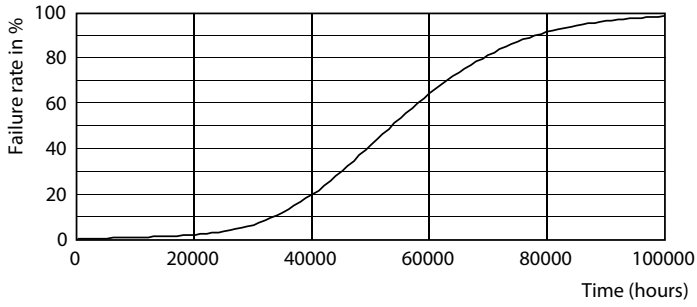

LEDTube 1200 mm 18W 840 T8 I W

LEDTube 1200 mm 18W 840 T8 I W LumenVsTc

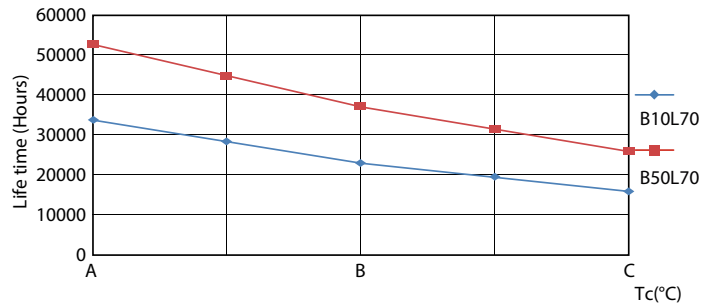
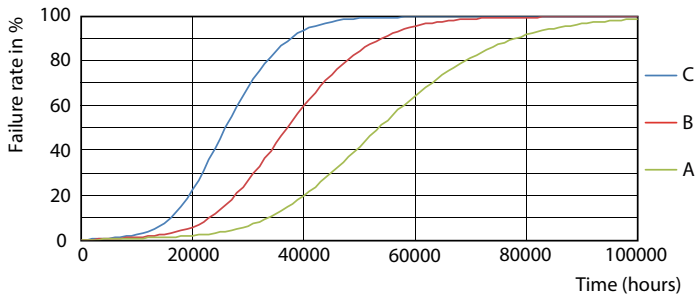

LEDTube 1200 mm 18W 840 T8 I W FailureRate

LEDTube 1200 mm 18W 840 T8 I W LifetimeVsTc

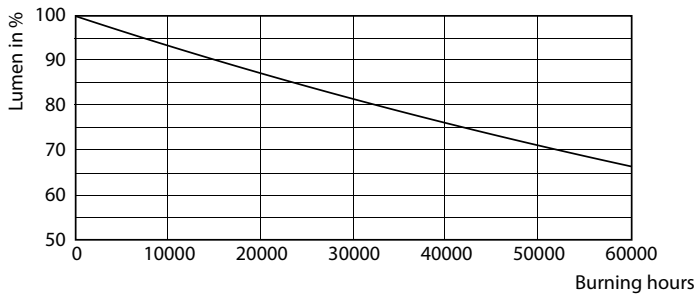

LEDTube 1200 mm 18W 840 T8 I W

MASTER LEDtube EM/Mains

