



# CorePro LED PLC

## CorePro LED PLC 8.5W 840 2P G24d-3

Philips CorePro LED PLC is the ideal uplampping solution for downlights in a wide range of general lighting applications. It integrates a LED light source into a traditional fluorescent form factor to offer superb energy savings over a lifetime that's twice as long as fluorescent alternatives.

### Product data

General Information	
Cap base	G24D-3 [ G24d-3]
Nominal lifetime (nom.)	30000 h
Switching cycle	50000X
Light Technical	
Colour code	841 [ CCT of 4100K (841)]
Luminous flux (nom.)	1000 lm
Luminous flux (rated) (nom.)	1000 lm
Correlated colour temperature (nom.)	4000 K
Colour consistency	<6
Color rendering index (nom.)	83
LLMF at end of nominal lifetime (nom.)	70 %
Operating and Electrical	
Input frequency	50 to 60 Hz
Power (Rated) (Nom)	8.5 W
Lamp current (max.)	43 mA
Lamp current (min.)	33 mA
Starting time (nom.)	0.5 s
Warm-up time to 60% light (nom.)	0.5 s
Power factor (nom.)	0.9

Voltage (Nom)	220-240 V
Temperature	
T ambient (max.)	35 °C
T ambient (min.)	-20 °C
T storage (max.)	65 °C
T storage (min.)	-40 °C
T-Case maximum (nom.)	75 °C
Controls and Dimming	
Dimmable	No
Mechanical and Housing	
Product length	200 mm
Approval and Application	
Energy efficiency label (EEL)	A+
Energy-saving product	Yes
Approval marks	CE marking RoHS compliance KEMA Keur certificate
Energy Consumption kWh/1000 h	11 kWh

# CorePro LED PLC

## Product Data

Full product code	871869654125800
Order product name	CorePro LED PLC 8.5W 840 2P G24d-3
EAN/UPC – product	8718696541258
Order code	54125800
Numerator – quantity per pack	1

Numerator – packs per outer box	10
Material no. (12NC)	929001201302
Net weight (piece)	0.090 kg

## Dimensional drawing

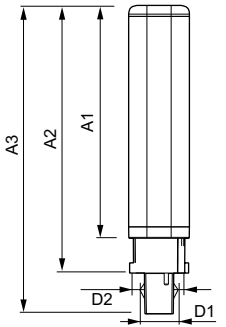

LEDtube PLC 8.5W G24d-3/840 2P

Product	D1	D2	A1	A2	A3
CorePro LED PLC 8.5W 840 2P G24d-3	24.3 mm	28.4 mm	128.8 mm	148 mm	170.6 mm

## Photometric data

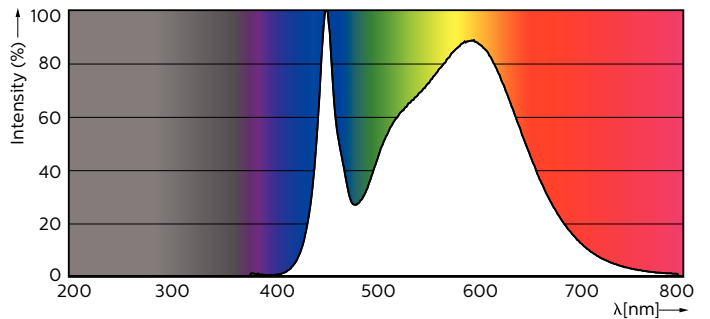
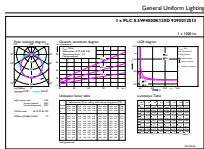

LEDtube PLC 100mm 9W G24D-3 840 1000lm

LEDtube PLC 100mm 9W G24Q-3 840 1000lm

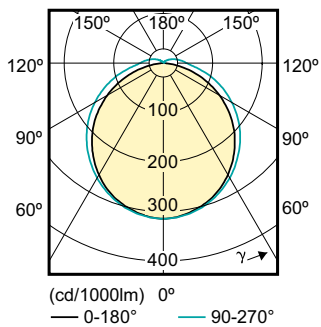

# CorePro LED PLC

## Lifetime

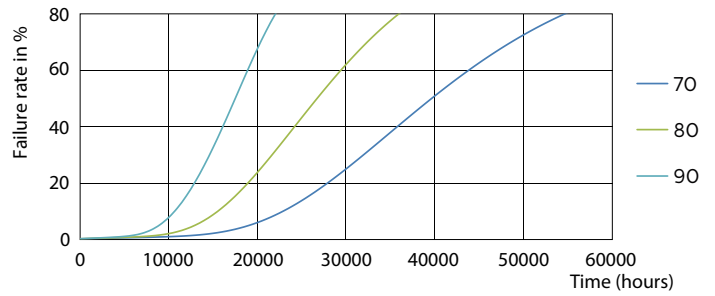
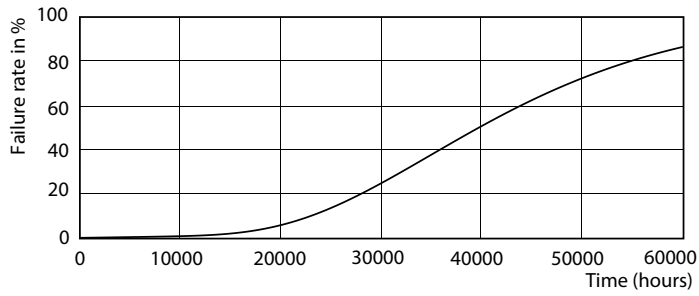

LEDtube PLC 100mm 9W G24D-3 830 950lm

LEDtube PLC 100mm 9W G24D-3 830 950lm

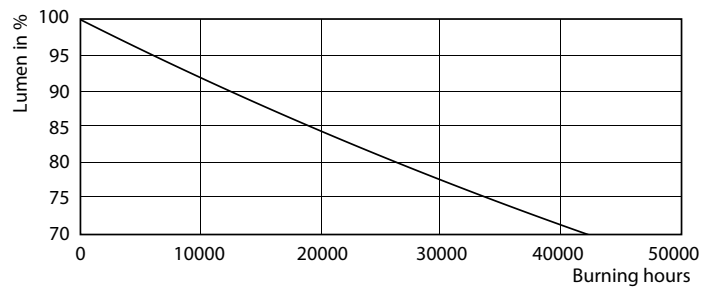
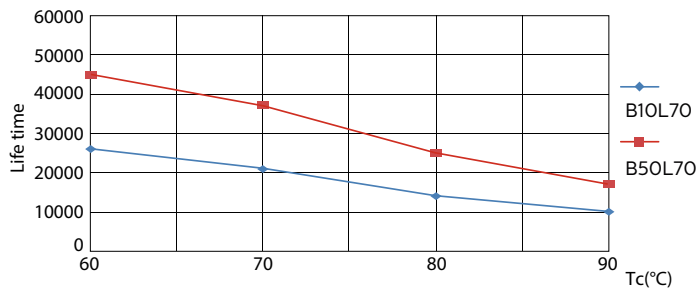

LEDtube PLC 100mm 9W G24D-3 830 950lm

LEDtube PLC 100mm 9W G24D-3 830 950lm

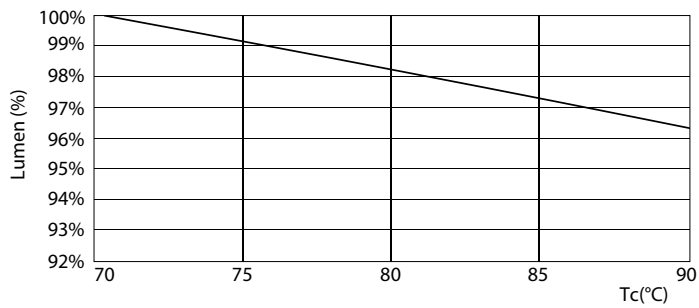

LEDtube PLC 100mm 9W G24D-3 830 950lm

