



# CorePro LED PLC 2P

## LED PLC 6.5W 840 2P G24d-2

The CorePro LED PLC 2P integrates a LED light source into a traditional fluorescent form factor. This product is the ideal solution for uplamping in general lighting applications: it meets basic lighting requirements, offers significant energy savings and is environmentally friendly.

### Product data

| General Information                    |                           | Voltage (Nom)                 |                 |
|--|---------------------------|-------------------------------|-----------------|
| Cap base                               | G24D-2 [ G24d-2]          | 220-240 V                     |                 |
| EU RoHS compliant                      | Yes                       | Temperature                   |                 |
| Nominal lifetime (nom.)                | 30000 h                   | T ambient (max.)              | 35 °C           |
| Switching cycle                        | 50000X                    | T ambient (min.)              | -20 °C          |
| Light Technical                        |                           | T storage (max.)              | 65 °C           |
| Colour code                            | 841 [ CCT of 4100K (841)] | T storage (min.)              | -40 °C          |
| Luminous flux (nom.)                   | 700 lm                    | T-Case maximum (nom.)         | 65 °C           |
| Correlated Colour Temperature (Nom)    | 4000 K                    | Controls and Dimming          |                 |
| Colour consistency                     | <6                        | Dimmable                      | No              |
| Color rendering index (nom.)           | 83                        | Mechanical and Housing        |                 |
| LLMF at end of nominal lifetime (nom.) | 70 %                      | Product length                | 100 mm          |
| Operating and Electrical               |                           | Approval and Application      |                 |
| Input frequency                        | 50 to 60 Hz               | Energy efficiency label (EEL) | A+              |
| Power (Rated) (Nom)                    | 6.5 W                     | Energy-saving product         | Yes             |
| Lamp current (max.)                    | 35 mA                     | Approval marks                | CE marking      |
| Lamp current (min.)                    | 25 mA                     | Energy Consumption kWh/1000 h | 9 kWh           |
| Starting time (nom.)                   | 0.5 s                     | Product Data                  |                 |
| Warm-up time to 60% light (nom.)       | 0.5 s                     | Full product code             | 871869667005700 |
| Power factor (nom.)                    | 0.9                       |                               |                 |

# CorePro LED PLC 2P

|                                 |                            |
|---------------------------------|----------------------------|
| Order product name              | LED PLC 6.5W 840 2P G24d-2 |
| EAN/UPC – product               | 8718696670057              |
| Order code                      | 67005700                   |
| Numerator – quantity per pack   | 1                          |
| Numerator – packs per outer box | 10                         |

|                     |              |
|---------------------|--------------|
| Material no. (12NC) | 929001201508 |
| Net weight (piece)  | 0.077 kg     |

## Dimensional drawing



| Product                    | D1      | D2      | A1       | A2     | A3       |
|----------------------------|---------|---------|----------|--------|----------|
| LED PLC 6.5W 840 2P G24d-2 | 24.3 mm | 28.4 mm | 105.8 mm | 125 mm | 147.6 mm |

## LEDtube PLC 6.5W G24d-2/840 2P

## Photometric data

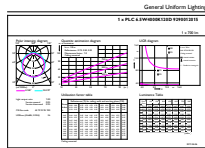

General Information E1 Photo Lighting E1 Page 117

## LEDtube PLC 100mm 7W G24D-2 840 700lm

## LEDtube PLC 100mm 9W G24Q-3 840 1000lm

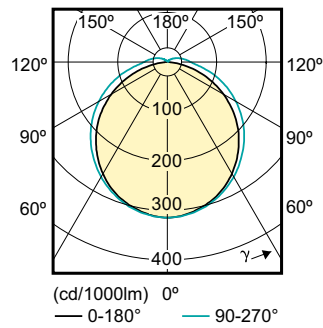

# CorePro LED PLC 2P

## Lifetime

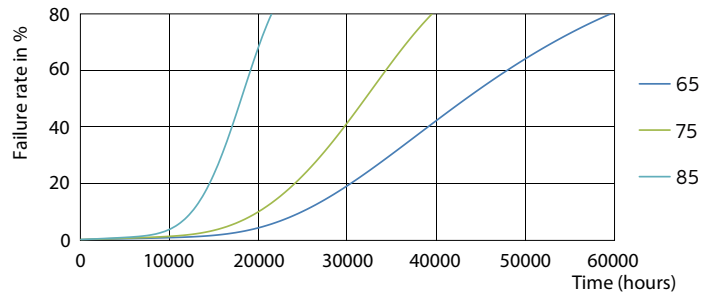
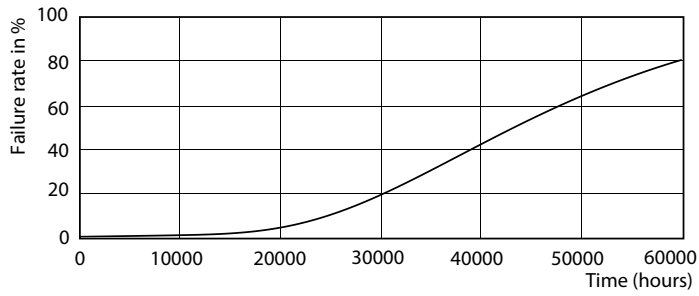

LEDtube PLC 100mm 7W G24D-2 830 650lm

LEDtube PLC 100mm 7W G24D-2 830 650lm

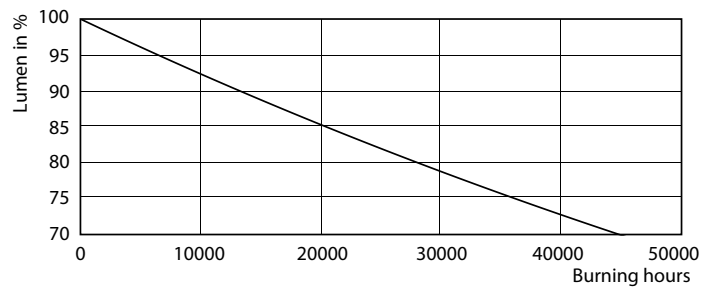
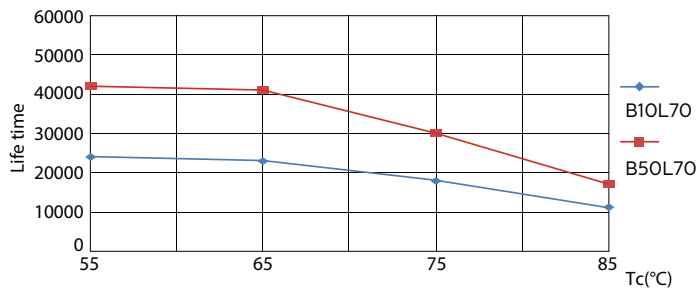

LEDtube PLC 100mm 7W G24D-2 830 650lm

LEDtube PLC 100mm 7W G24D-2 830 650lm

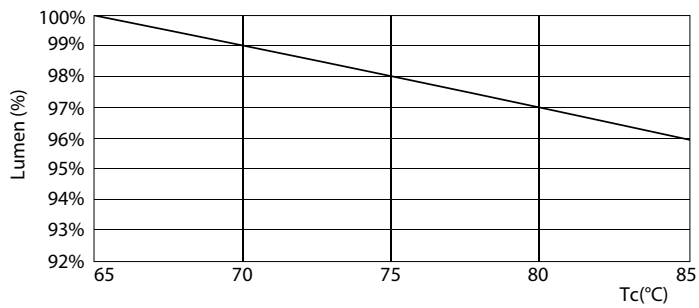

LEDtube PLC 100mm 7W G24D-2 830 650lm

## CorePro LED PLC 2P

