



CorePro LED PLC 2P

LED PLC 6.5W 840 2P G24d-2

CorePro LED PLC 2P integrates a LED light source into a traditional fluorescent form factor. This product is the ideal solution for uplamping in general lighting applications: it meets basic lighting requirements, offers significant energy savings, and is environmentally friendly.

Product data

General Information		Lamp Current (Min)	
Cap-Base	G24d-2		25 mA
Nominal lifetime	30,000 hour(s)	Starting Time (Nom)	0.5 s
Switching Cycle	50,000	Warm-up time to 60% light	0.5 s
Lighting Technology	LED	Power Factor (Fraction)	0.9
EU RoHS compliant	Yes	Voltage (Nom)	220-240 V
Light Technical		Temperature	
Color Code	840 [CCT of 4000K]	Ambient temperature range	-20 °C to 35 °C
Beam Angle (Nom)	120 degree(s)	T-Case Maximum (Nom)	65 °C
Luminous Flux	700 lm	Controls and Dimming	
Color Designation	Cool White (CW)	Dimmable	No
Correlated Color Temperature (Nom)	4000 K	Mechanical and Housing	
Luminous Efficacy (rated) (Nom)	107.00 lm/W	Product Length	100 mm
Color Consistency	<6	Bulb Shape	PL-C
Color rendering index (CRI)	83	Approval and Application	
LLMF At End Of Nominal Lifetime (Nom)	70 %	Energy Saving Product	Yes
Operating and Electrical		Approval Marks	TUV CE marking
Line Frequency	50 to 60 Hz	Energy Consumption kWh/1000 h	9 kWh
Input Frequency	50 to 60 Hz		
Power Consumption	6.5 W		
Lamp Current (Max)	35 mA		

CorePro LED PLC 2P

Product Data

Order product name	LED PLC 6.5W 840 2P G24d-2
Full product name	LED PLC 6.5W 840 2P G24d-2
Full product code	871869667005700
Order code	929001201508
Material Nr. (12NC)	929001201508

Numerator - Quantity Per Pack	1
EAN/UPC - Product/Case	8718696670057
Numerator - Packs per outer box	10
EAN/UPC - Case	8718696670064

Dimensional drawing

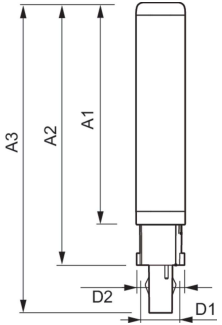

Product	D1	D2	A1	A2	A3
LED PLC 6.5W 840 2P G24d-2	24.3 mm	28.4 mm	105.8 mm	125 mm	147.6 mm

Photometric data

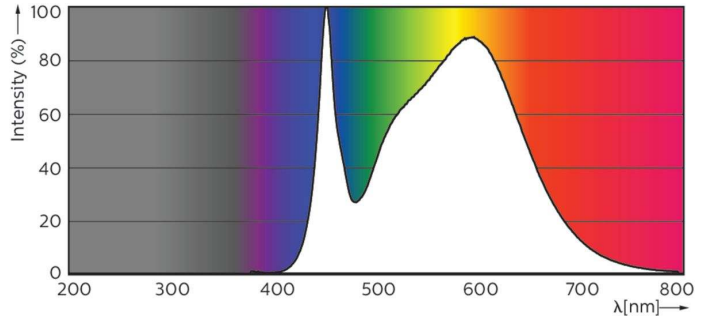
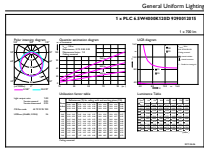

General uniform lighting - LED PLC 6.5W 840 2P G24d-2

Spectral Power Distribution Colour - LED PLC 6.5W 840 2P G24d-2

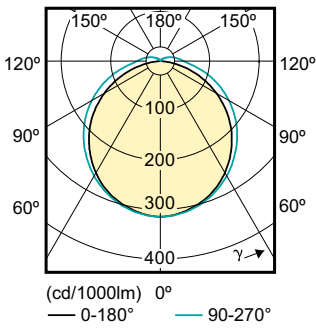

Light Distribution Diagram - LED PLC 6.5W 840 2P G24d-2

CorePro LED PLC 2P

Lifetime

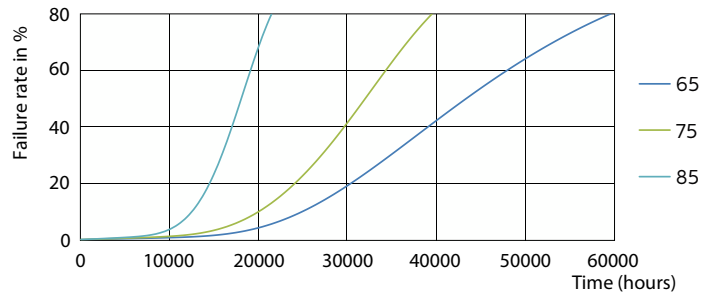
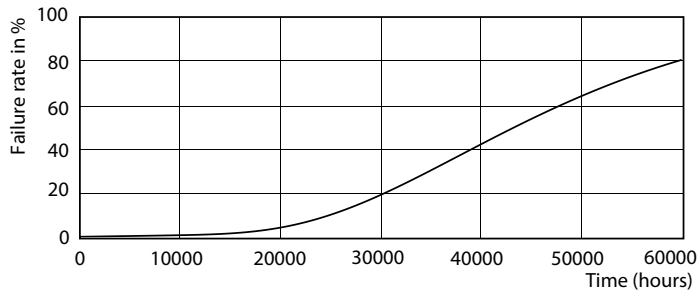

Life Expectancy Diagram - LED PLC 6.5W 840 2P G24d-2

Life Expectancy Diagram - LED PLC 6.5W 840 2P G24d-2

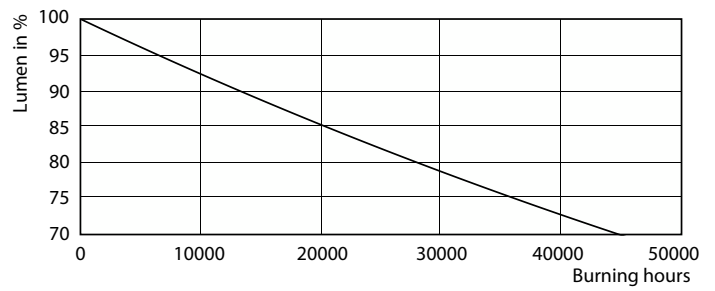
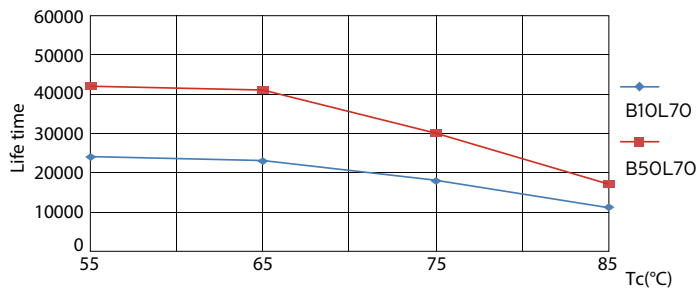

Life Expectancy Diagram - LED PLC 6.5W 840 2P G24d-2

Lumen Maintenance Diagram - LED PLC 6.5W 840 2P G24d-2

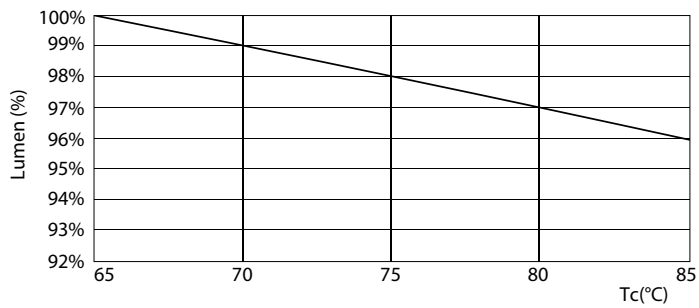

Lumen Maintenance Diagram - LED PLC 6.5W 840 2P G24d-2

CorePro LED PLC 2P

