



CorePro LED PLC 2P

LED PLC 6.5W 840 2P G24d-2

CorePro LED PLC 2P integrates a LED light source into a traditional fluorescent form factor. This product is the ideal solution for uplamping in general lighting applications: it meets basic lighting requirements, offers significant energy savings, and is environmentally friendly.

Product data

General Information	
Cap-Base	G24d-2
Nominal lifetime	30,000 hour(s)
Switching Cycle	50,000
Lighting Technology	LED
EU RoHS compliant	Yes

Light Technical	
Color Code	840 [CCT of 4000K]
Beam Angle (Nom)	120 degree(s)
Luminous Flux	700 lm
Color Designation	Cool White (CW)
Correlated Color Temperature (Nom)	4000 K
Luminous Efficacy (rated) (Nom)	107.00 lm/W
Color Consistency	<6
Color rendering index (CRI)	83
LLMF At End Of Nominal Lifetime (Nom)	70 %

Operating and Electrical	
Line Frequency	50 to 60 Hz
Input Frequency	50 to 60 Hz
Power Consumption	6.5 W
Lamp Current (Max)	35 mA

Lamp Current (Min)	25 mA
Starting Time (Nom)	0.5 s
Warm-up time to 60% light	0.5 s
Power Factor (Fraction)	0.9
Voltage (Nom)	220-240 V

Temperature	
Ambient temperature range	-20 °C to 35 °C
T-Case Maximum (Nom)	65 °C

Controls and Dimming	
Dimmable	No

Mechanical and Housing	
Product Length	100 mm
Bulb Shape	PL-C

Approval and Application	
Energy Saving Product	Yes
Approval Marks	TUV CE marking
Energy Consumption kWh/1000 h	9 kWh

CorePro LED PLC 2P

Product Data

Order product name	LED PLC 6.5W 840 2P G24d-2
Full product name	LED PLC 6.5W 840 2P G24d-2
Full product code	871869667005700
Order code	929001201508
Material Nr. (12NC)	929001201508

Numerator - Quantity Per Pack	1
EAN/UPC - Product/Case	8718696670057
Numerator - Packs per outer box	10
EAN/UPC - Case	8718696670064

Dimensional drawing

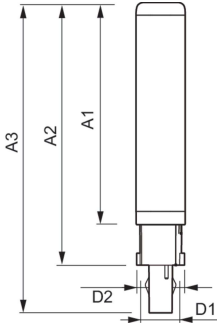

Product	D1	D2	A1	A2	A3
LED PLC 6.5W 840 2P G24d-2	24.3 mm	28.4 mm	105.8 mm	125 mm	147.6 mm

Photometric data

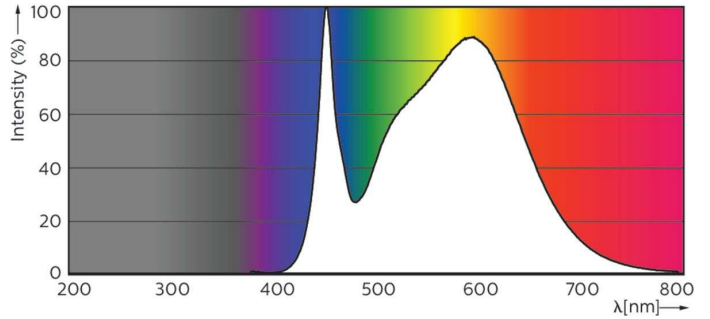
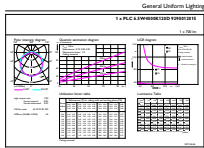

General uniform lighting - LED PLC 6.5W 840 2P G24d-2

Spectral Power Distribution Colour - LED PLC 6.5W 840 2P G24d-2

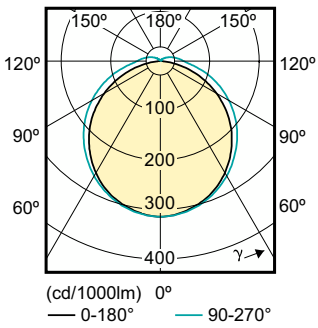

Light Distribution Diagram - LED PLC 6.5W 840 2P G24d-2

CorePro LED PLC 2P

Lifetime

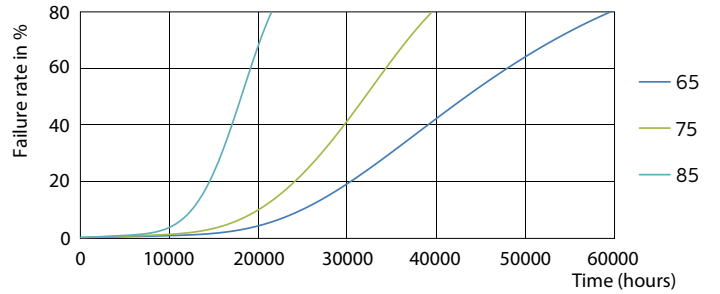
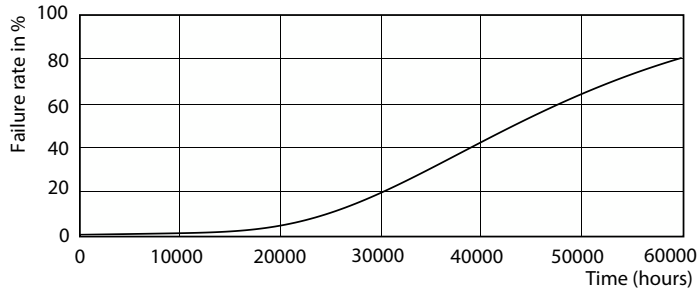

Life Expectancy Diagram - LED PLC 6.5W 840 2P G24d-2

Life Expectancy Diagram - LED PLC 6.5W 840 2P G24d-2

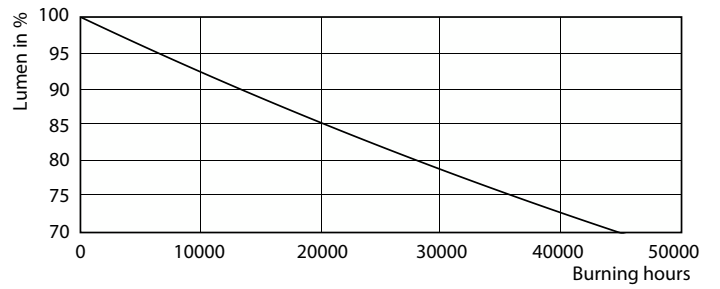
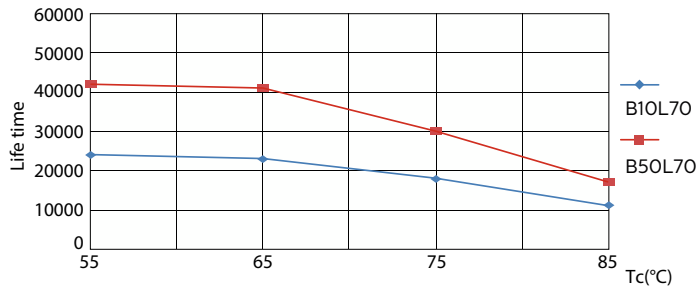

Life Expectancy Diagram - LED PLC 6.5W 840 2P G24d-2

Lumen Maintenance Diagram - LED PLC 6.5W 840 2P G24d-2

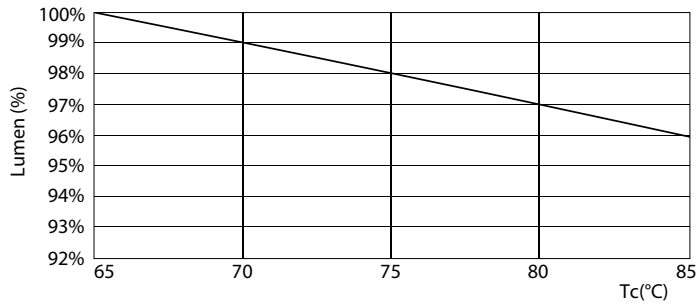

Lumen Maintenance Diagram - LED PLC 6.5W 840 2P G24d-2

CorePro LED PLC 2P

