

PHILIPS

hue personal
wireless
lighting

Lily base unit



HUE serial number



User manual
Notice d'emploi
Manual de usuario

Incl.

A



3X

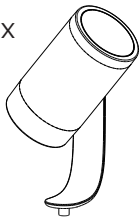

3X



3X

B



3X

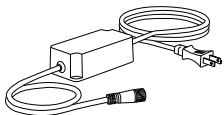
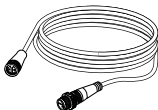

2X



Excl.

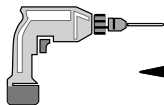

+



B

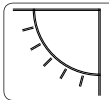

MAX. 40 W



EN IMPORTANT SAFETY INSTRUCTIONS

- Product appearance may vary from image shown.
- UL Listed Landscape Lighting System. This luminaire and power supply unit is intended for installation in accordance with the National Electrical Code and local code specifications. Failure to adhere to these codes and instructions may result in serious injury and/or damage to the PSU and void the warranty. These instructions do not purport to cover all details or variations in equipment, nor to provide for every possible contingency related to installation, operation, maintenance, or mounting situation. Should specific problems occur that are not addressed by these instructions, contact your Sales Representative or distributor for assistance. SAVE THESE INSTRUCTIONS for future reference.
- Warning: do not use an extension cord.
- The plug on the power supply unit must be connected to a GFCI protected hooded flush type cover plate receptacle marked "Wet Location" while in use.
- Protect the wire by routing it in close proximity to the light fitting, or next to a building structure such as a house or a deck.
- The landscape wire and connector can also be hidden under stone or buried under grass at a maximum depth of 6 inches (15.2 cm).
- Philips recommends a minimum depth of 4 inches when burying in the lawn to prevent damage from aerators or other lawn plugging equipment.
- Philips recommends not to bury the T-shaped connectors.
- Do not submerge luminaire or PSU in water.
- **WARNING:** Risk of Electric Shock. Do not install power supply unit or luminaires within 10 feet (3.05 m) of a pool, spa, or fountain.

FR MÉSURES DE SÉCURITÉ À RESPECTER

- L'apparence du produit peut différer de l'image montrée.
- Système d'éclairage paysager homologué UL. Ce luminaire et bloc d'alimentation est conçu pour être installé conformément au Code national de l'électricité et aux spécifications des codes locaux. Le non-respect de ces codes et instructions peut entraîner des blessures graves et/ou endommager le bloc d'alimentation et annuler la garantie. Ces instructions ne prétendent pas couvrir tous les détails ou les variations de l'équipement, ni fournir une éventualité liée à l'installation, l'opération, la maintenance ou la situation de montage. Si des problèmes spécifiques se produisent, veuillez contacter votre représentant commercial ou votre distributeur pour obtenir de l'aide. CONSERVEZ CES INSTRUCTIONS pour référence future.
- Attention: ne pas utiliser une rallonge.
- La fiche du bloc d'alimentation doit être connectée à un réceptacle de plaque de recouvrement à couvercle à capuchon protégé par GFCI marqué "Emplacement humide" pendant l'utilisation.
- Protégez le fil en l'acheminant à proximité du luminaire ou à proximité d'une structure de bâtiment comme une maison ou un pont.

- Le fil et le connecteur peuvent également être enterrés sous l'herbe à une profondeur maximale de 6 pouces (15,2 cm).
- Philips recommande une profondeur minimale de 4 pouces lors de l'enfouissement dans la pelouse pour éviter les dommages causés par les aérateurs ou d'autres équipements de branchage.
- Philips recommande de ne pas enterrer les connecteurs en forme de T.
- Ne pas submerger le luminaire ou le bloc d'alimentation dans l'eau
- **AVERTISSEMENT:** Risque de choc électrique. N'installez pas le bloc d'alimentation ou les luminaires à moins de 10 pieds (3,05 m) d'une piscine, un spa ou une fontaine.

ES

INSTRUCCIONES DE SEGURIDAD IMPORTANTES

- La apariencia del producto puede variar de la imagen mostrada.
- Sistema de iluminación de jardín listado por UL. La luminaria y la unidad de fuente de alimentación están diseñadas para su instalación de acuerdo con el Código Eléctrico Nacional y las especificaciones del código local. El incumplimiento de estos códigos e instrucciones puede provocar lesiones graves y/o daños a la fuente de alimentación y anular la garantía. Estas instrucciones no pretenden cubrir todos los detalles o variaciones en el equipo, ni prever todas las contingencias posibles relacionadas con la instalación, operación, mantenimiento o situación de montaje. Si se producen problemas específicos que no se abordan en estas instrucciones, comuníquese con su representante de ventas o distribuidor para obtener ayuda. **GUARDE ESTAS INSTRUCCIONES** para referencia futura.
- Advertencia: no use un cable de extensión.
- El enchufe de la unidad de fuente de alimentación debe estar conectado a un receptáculo de placa de cubierta tipo Flush con protección GFCI marcado como "Ubicación húmeda" mientras está en uso.
- Proteja el cable conduciéndolo cerca de la luminaria, o junto a la estructura de un edificio, como una casa o tejado.
- El cable y el conector también pueden esconderse debajo de piedra o enterrarse bajo el césped a una profundidad máxima de 6 pulgadas (15.2 cm).
- Philips recomienda una profundidad mínima de 4 pulgadas cuando se entierre en el césped para evitar daños.
- Philips recomienda no enterrar los conectores en forna de T.
- No sumerja la luminaria o fuente de alimentación en agua.
- **ADVERTENCIA:** Riesgo de descarga eléctrica. No instale la fuente de alimentación ni las luminarias a menos de 10 pies (3.05 m) de una piscina, spa o fuente.

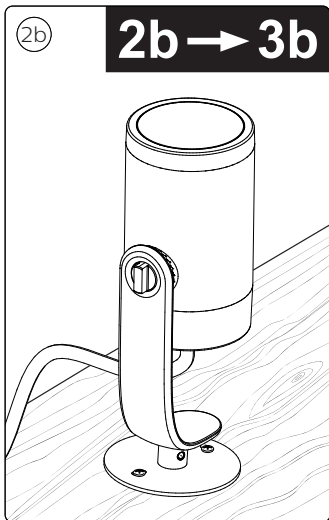
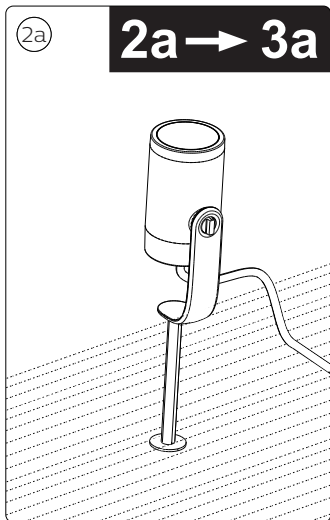
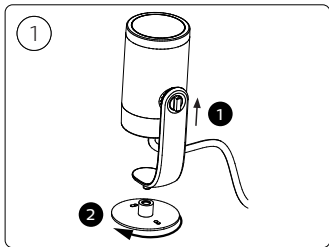
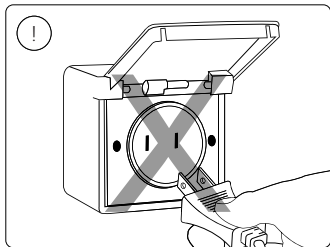

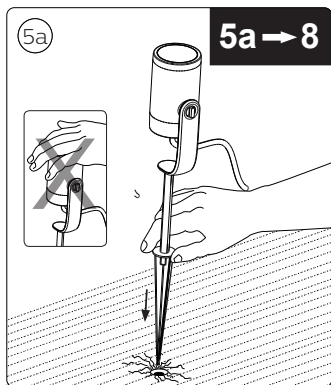
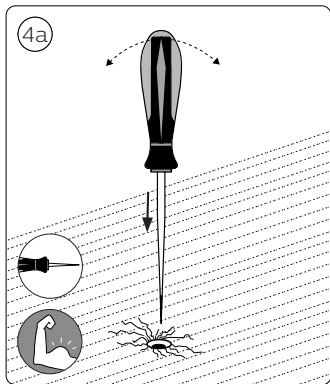
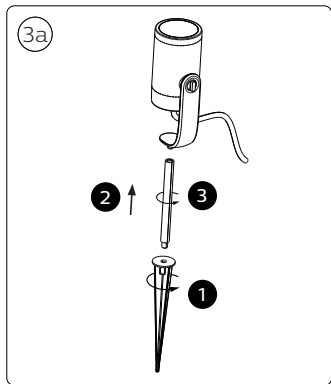

3b

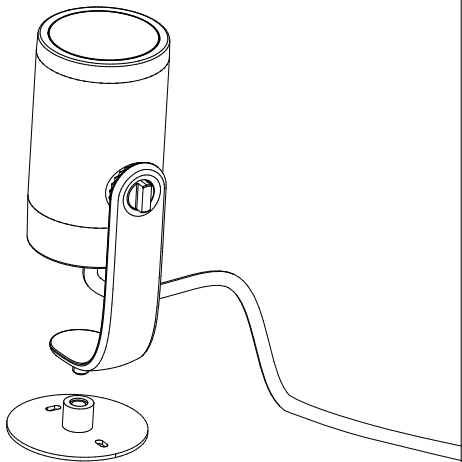

4b

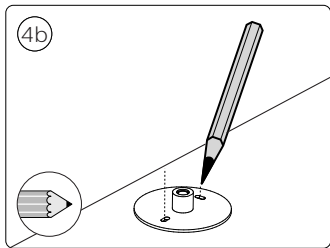

5b

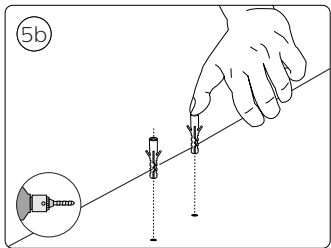

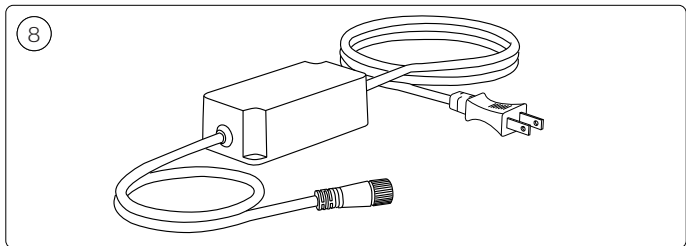
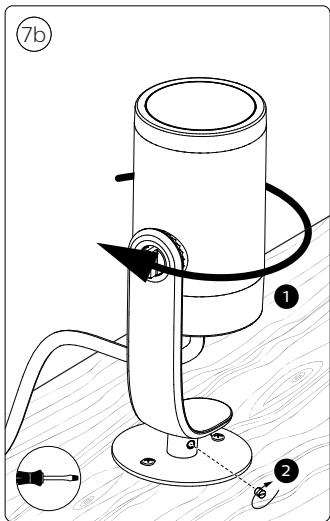
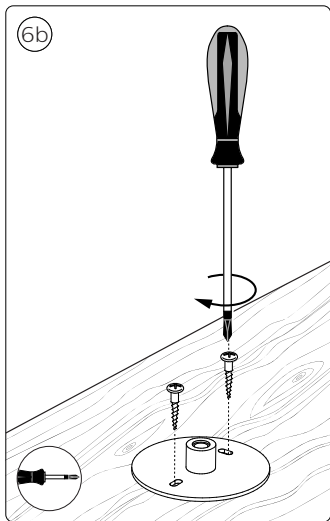

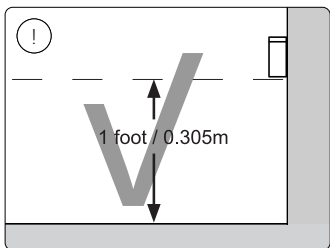
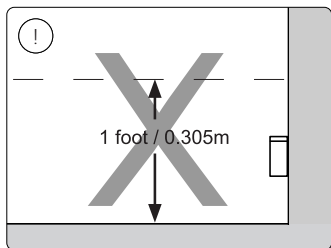
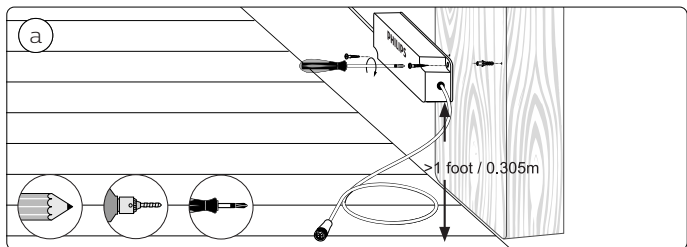
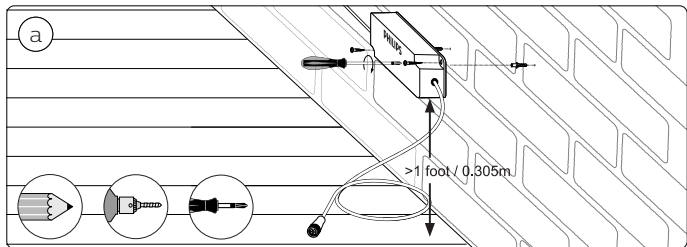

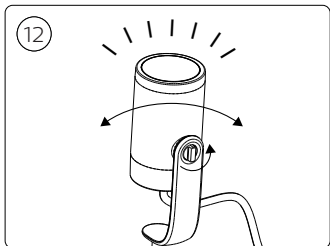
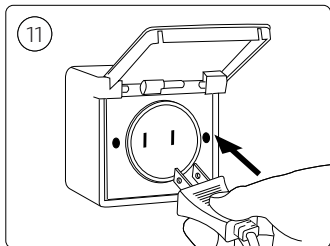
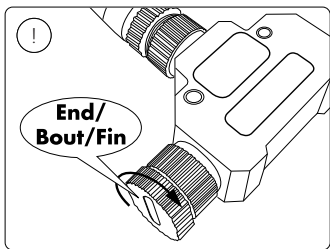
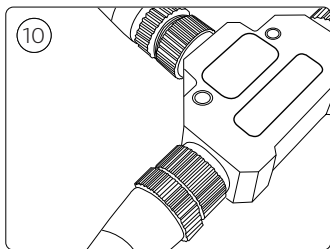
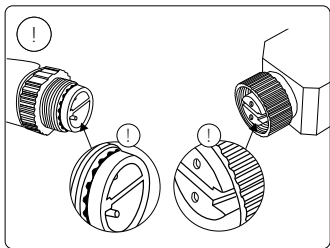
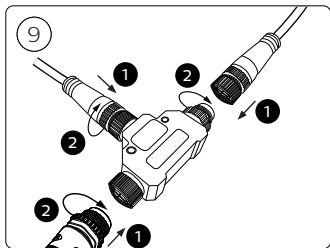

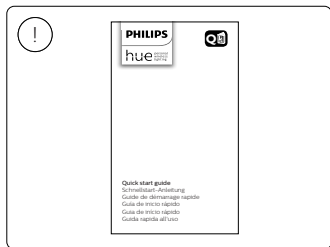
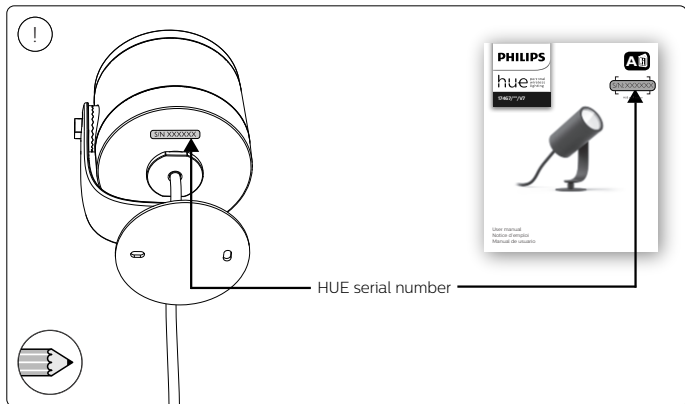



- EN** Use only with Philips HUE 24V **SELV** LED Power Supply!
- FR** À utiliser uniquement avec une source d'alimentation à DEL SELV Philips Hue de 24V **SELV** !
- ES** Usar solo con una fuente de alimentación Philips Hue 24V **SELV** LED!

Philips Hue Low-volt system (24V)

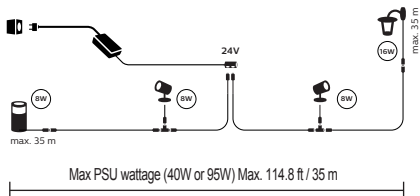



Signify North America Corporation
400 Crossing Blvd, Suite 600
Bridgewater, NJ 08807, USA

Signify Canada Ltd./Signify Canada Ltée.
281 Hillmount Road,
Markham, ON, Canada L6C 2S3
Questions or Comments / Questions ou commentaires :
1-800-555-0050

Signify Mexico S.A. De C.V.
Av. La Palma No. 6,
La Herradura, Huixquilucan,
Edo de México, C.P. 52784, México
R.F.C. PME-620620-E84
Centro de contacto:
01-800-508-9000

© 2021 Signify Holding
All rights reserved

www.philips-hue.com

4404 029 09554
Last update: 10/2021