

NOTE: THIS VERSION OF THE DEFINE SERIES HAS BEEN REPLACED WITH OUR SECOND GENERATION PRODUCT

NEO-RAY

DESCRIPTION

The Define series by Neo-Ray characterizes the ultimate in minimalist simplicity by providing clean, uniform lines of illumination in virtually any architectural environment. Powered by Cooper Lighting Solutions' most advanced linear LED technology, the Define series delivers outstanding efficacy in a variety of profile widths. 2", 3", 4" and 5" luminaire widths are all specifiable to the nearest foot as standard product and can be fitted with flush, regress and drop lensing. Custom corners and transitions are also available. Robust construction and adaptable, modular components make installation simple and ensure laser straight runs.

Catalog #		Type
Project		
Comments		Date
Prepared by		

SPECIFICATION FEATURES

Construction

Housing extruded from 6063 aluminum. Nominal 2' -12' illuminated sections. Used in run configuration and/or individual fixtures. All components are RoHs compliant.

Lens

Snap in lens available in flush and drop lens profiles. Lens end caps allow for ease of installation and eliminate light leak.

Finish

Fixture housings are high reflective white using electrostatically applied polyester powder coat paint.

Electrical

Long-life LED system coupled with electrical driver to deliver optimal performance. LED's are available in 2700K, 3000K, 3500K or 4000K with a typical CRI ≤ 85. Projected life is 153,000 hours at >79% lumen output. Electronic drivers are available for 120-277V applications. Fixtures and electrical components certified to UL and CUL standards. Fixtures are damp location listed.

Controls

Equipped standard with a 0-10V continuous dimming driver compatible with most standard dimming devices (refer to website for specific compatibility reference).

Combine with FifthLight DALI and other energy saving products like sensors, daylighting controls and building management systems to maximize energy savings.

Mounting

Wall.

Warranty

Five year warranty.

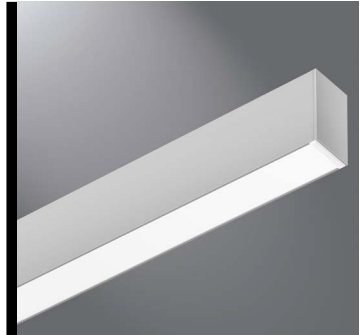

Define 3

Wall

LED

Direct

CERTIFICATION DATA
 cULus - 1598
 Damp Location Listed
 LM79/LM80 Compliant
 RoHS Compliant
 Lumawatt Pro Wireless

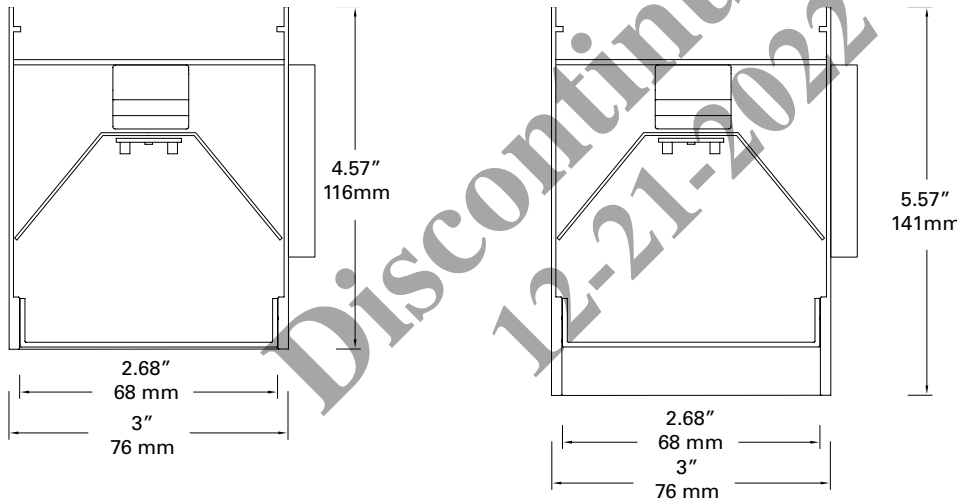

ORDERING INFORMATION

Sample Number: S123DW-235-0048-1D-UDD-4-W

SERIES	LIGHT DISTRIBUTION	LIGHT LEVEL ¹	CCT	LENGTH ³	CIRCUITING
S123 = Define 3	DW = Direct Wall RDW = Regressed Direct Wall	-LO = Light Level LO (1373Lms @ 13.6W) (343 Lumens per ft @ 3.4 W) -1 = Light Level 1 (2899 Lms @ 27.9W) (725 Lumens per ft @ 7W) -2 = Light Level 2 (4108 Lms @ 42.6W) (1027 Lumens per ft @ 10.65W) -LC = Custom Lm/Ft ¹	27 = 2700K 30 = 3000K 35 = 3500K 40 = 4000K	-0024 = 2' Individual ⁴ -0048 = 4' Individual -0096 = 8' Individual -0144 = 12' Individual -XXXX = Configurable Run ⁵	-1 = Single Circuit -2 = Dual Circuit
CIRCUIT TYPE	VOLTAGE	LED DRIVER	SHIELDING DOWN	COLOR	OPTIONS ⁹
D = Dimming (std) C = Non-Dimming B = Battery Pack ^{8, 10} E = Emergency G = Bodine GTD ¹⁰	-1 = 120V -2 = 277V -U = Universal 120V-277V -3 = 347V ⁶	ED = Non-Dimming DD = 0-10 Volt Dimming, 10% HCD = 0-10 Volt Dimming, 1% 5L = DALI Dimming ^{7, 10}	-1 = Satin White Diffuser -3 = Asymmetric Flush ¹¹ -4 = Satin Drop Diffuser	-W = Matte White -S = Silver -B = Black -C = Custom Color	-SVPD1 = Integrated Sensor -LWIPD1 = Lumawatt Pro Wireless Integral Sensor ¹³ -VCR = Vertical Corner -HCR = Horizontal Corner -90 = 90-CRI (Lower Lumens) -R = GLR Fast Fusing -F = GMR Slow Fusing



Notes:
* See page 3 for specific notes

PS508002EN
2019-03-19

Photometric Data - All data certified to LM-79 standards in a NAVLAB approved testing facility

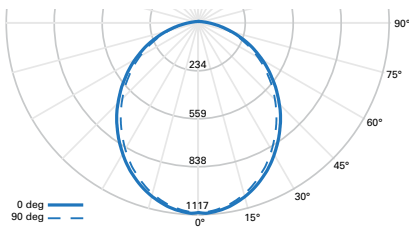

FILE NAME: S123DW-135-0048-1D-UDD-1-W

CCT: 3500K

LUMENS: 2899 Lms

WATTS: 27.9 W

LPW: 103.9 LPW

TEST NUMBER: P33912

ZONAL LUMENS SUMMARY

Zone	Lumens	% Fixture
0°-30°	837	28.9
0°-40°	1347	46.5
0°-60°	2318	80.0
0°-90°	2899	100.0

LUMINANCE DATA (cd/m²)

Vertical Angle	0°	45°	90°
45	11859	11633	11390
55	11190	10954	10740
65	10328	10008	9805
75	8646	8456	8266
85	5925	6207	6207

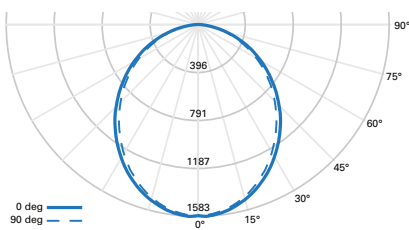

FILE NAME: S123DW-235-0048-1D-UDD-1-W

CCT: 3500K

LUMENS: 4108 Lms

WATTS: 42.6 W

LPW: 96.4 LPW

TEST NUMBER: P33923

ZONAL LUMENS SUMMARY

Zone	Lumens	% Fixture
0°-30°	1186	28.9
0°-40°	1909	46.5
0°-60°	3284	80.0
0°-90°	4108	100.0

LUMINANCE DATA (cd/m²)

Vertical Angle	0°	45°	90°
45	16805	16485	16139
55	15857	15522	15218
65	14634	14181	13892
75	12252	11981	11715
85	8394	8789	8789

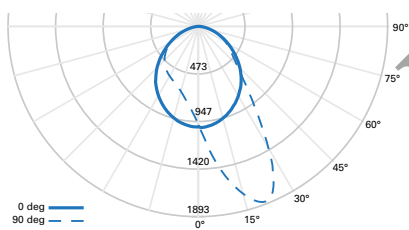

FILE NAME: S123DW-135-0048-1-UDD-3-W

CCT: 3500K

LUMENS: 3177 Lms

WATTS: 27.9 W

LPW: 113.9 LPW

TEST NUMBER: G2-1612-022-2

ZONAL LUMENS SUMMARY

Zone	Lumens	% Fixture
0°-30°	1030	32.4
0°-40°	1647	51.8
0°-60°	2649	83.4
0°-90°	3177	100.0

CANDELA DISTRIBUTION (cd)

Vertical Angle	0°	90°	180°	270°
0	1145	1145	1145	1145
10	1124	1734	1124	852
20	1035	2140	1041	721
25	977	2023	984	690
30	909	1583	920	660
40	754	794	765	596
50	566	499	580	502
60	379	352	388	381
70	212	208	217	242
80	76	77	80	100
90	0	0	0	0

LUMEN MAINTENANCE

Ambient Temperature	TM-21 Lumen Maintenance (100,000 hours)	Theoretical L70 (Hours)
25°C	84.29%	131,000

Mounting Information - Refer to installation instructions for detailed mounting information

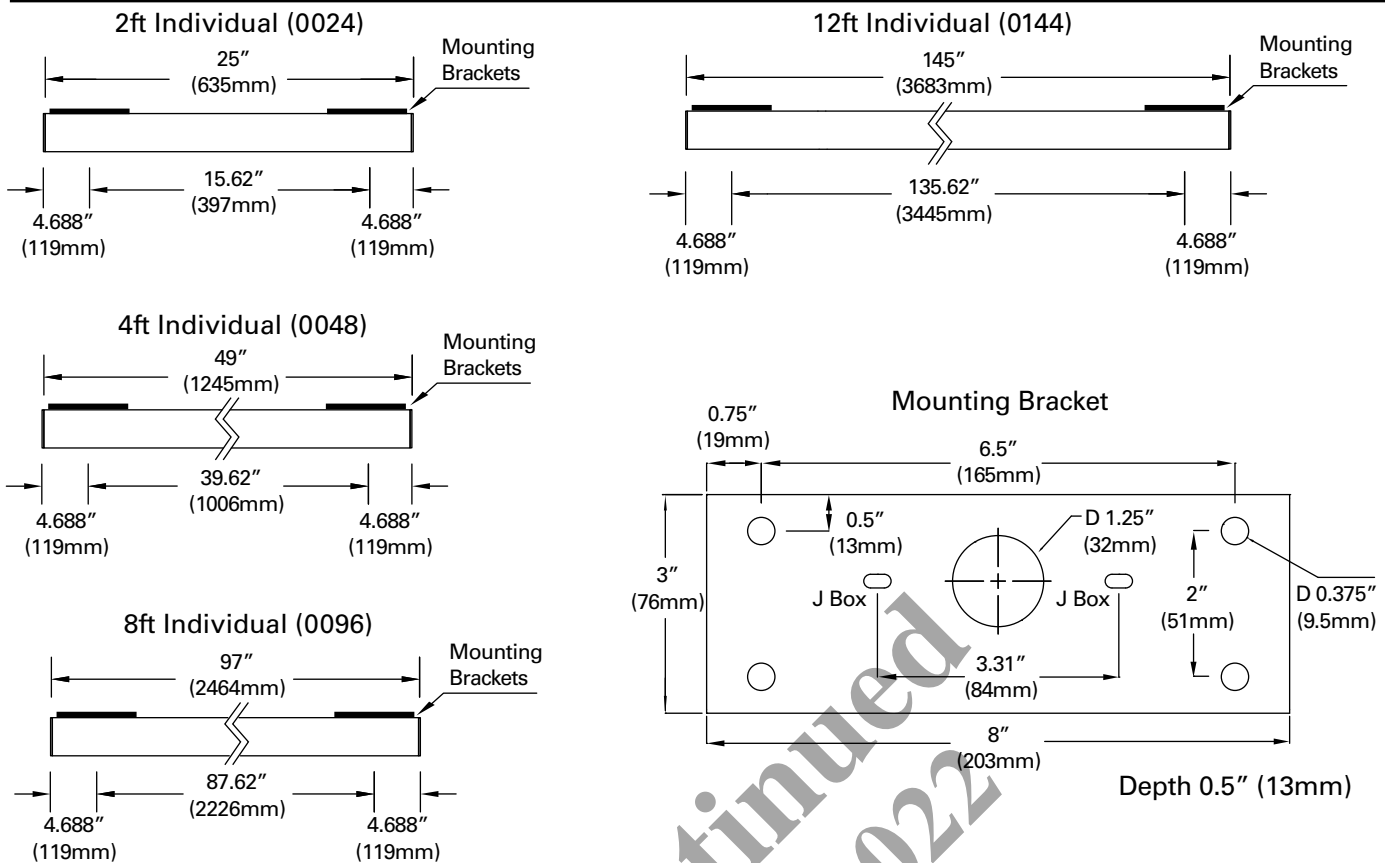

Lens Information - Lens Details

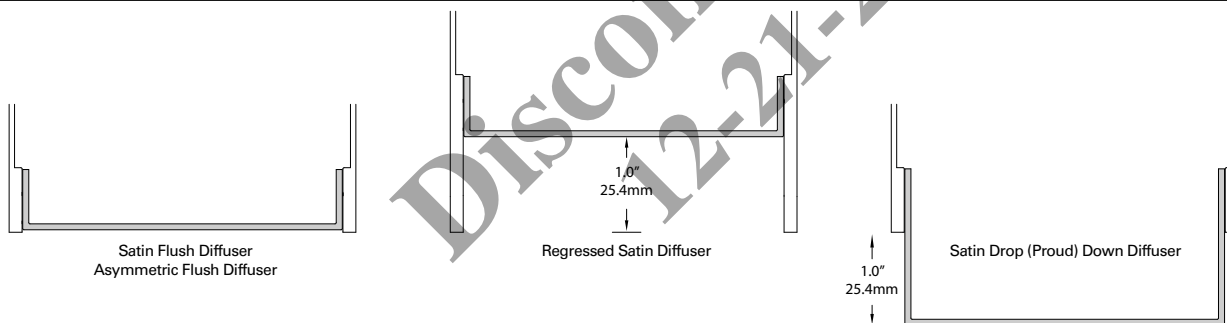

NOTES

- Additional lower light levels are available depending on fixture length. For the HCD driver, the requested output must be between 225 Lms/ft and 1030 Lms/ft. Additional drivers and light levels are available - please consult factory for details and lead-time.
- Not all ceiling types are shown; consult factory for specific ceiling types not listed.
- All lengths are nominal. Refer to submittal drawings for actual sizes.
- Not all dimming options available for every length; please consult factory for specific details.
- For configurable runs specify length to nearest foot. Standard runs ship in 12ft increments. Ensure to specify 8ft increments if 12ft are too large to receive. Additional charges may apply; please consult factory for details.
- 347V is achieved using remote transformer.
- FifthLight DALI is achieved using digital analog converter.
- Battery pack options are not available in every length; please consult factory for specific details. Battery pack is remote installation only.
- For all options; consult factory for specific requirements.
- Not available with 347V circuit.
- Asymmetric lens is not available as standard product on regressed housing RDR.
- Standard product is configured with snap-in lens end caps at the beginning and end of a run or individual fixture. End caps are provided for ease of installation and removal of the lens and eliminate light leak from the end of the fixture when flush satin lens is selected. Please contact factory if lens end-caps are not desired as alternate configurations are available.
- Integrated LumaWatt Pro Sensor available as a PDR in 4ft, 8ft, and 12ft configurations. Continuous runs and alternate lengths are also available. Please consult factory for details. One sensor for every 8ft of fixture length. Standard configurations include Universal voltage, single circuit and 'DD' driver selection. Not available with regressed housing or emergency options.