

# PHILIPS

hue personal  
wireless  
lighting

Centris



Hue serial number:  
Серийный номер Hue

1

2

3



1

2

3

User manual  
Benutzerhandbuch  
Notice d'emploi  
Manual de usuario  
Manual do usuário  
Manuale d'uso

Руководство пользователя  
Посібник користувача  
Пайдаланушы нұсқаулығы

Incl./Вкл.

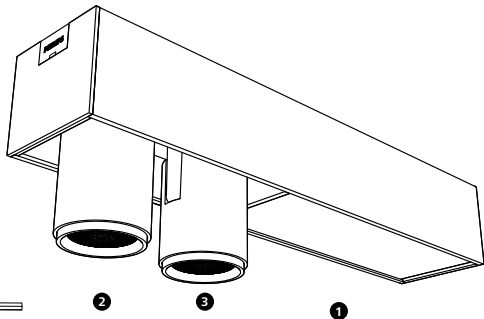
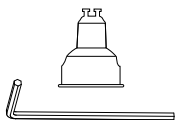

1

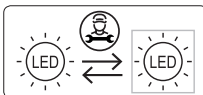

2

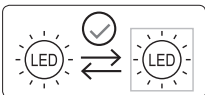

3



Excl./  
Искл.

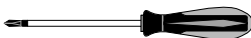
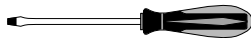
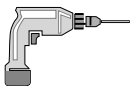

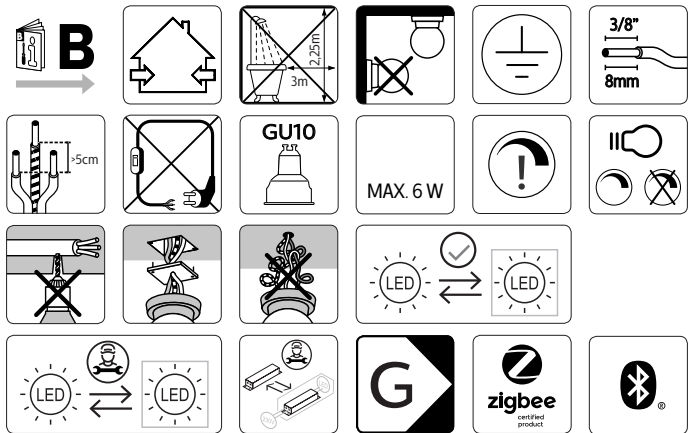

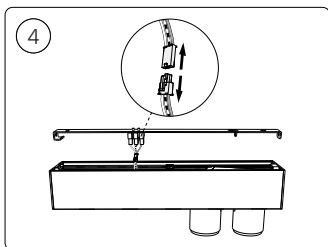
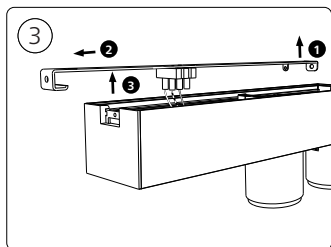
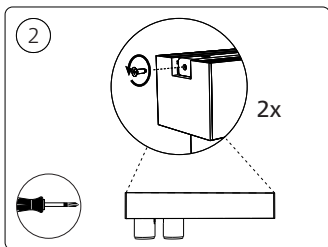
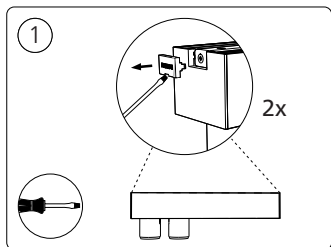
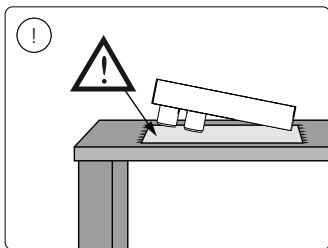
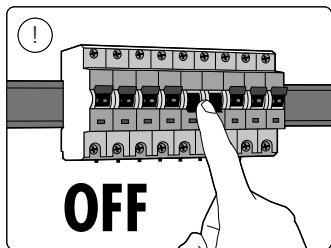

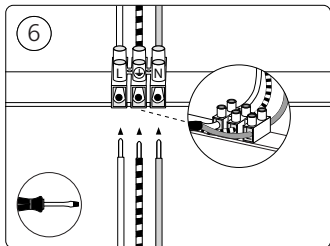
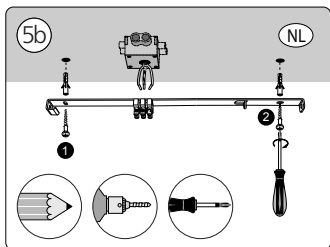
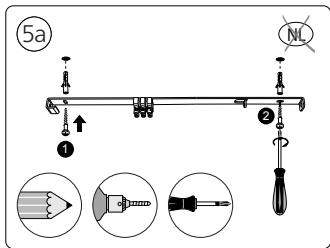

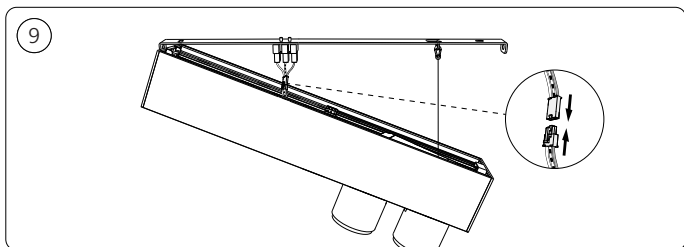
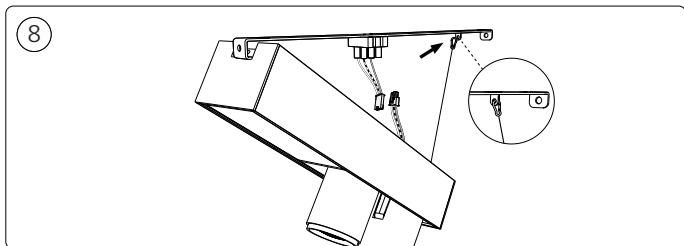
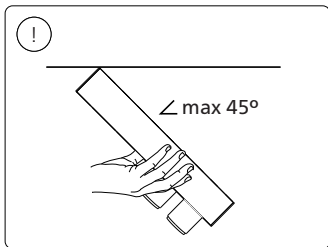
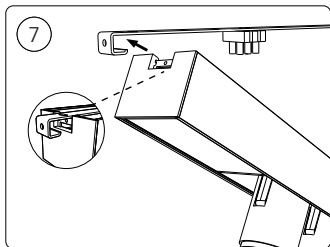

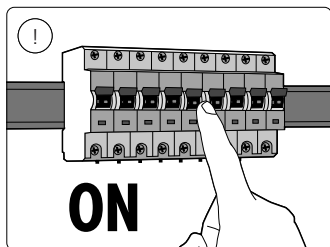
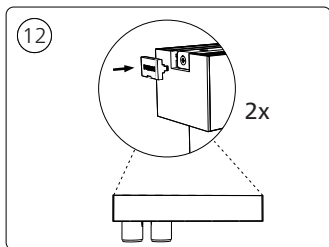
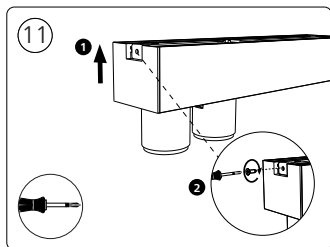
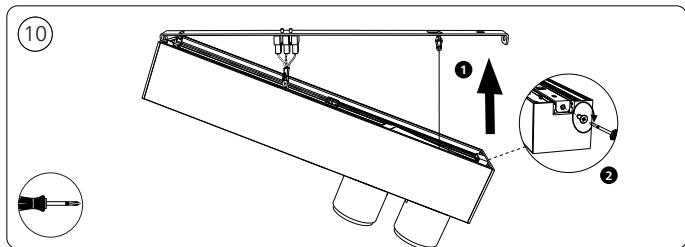

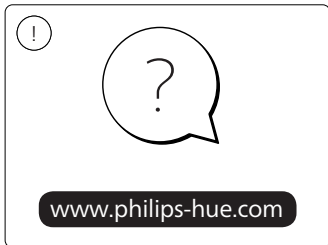
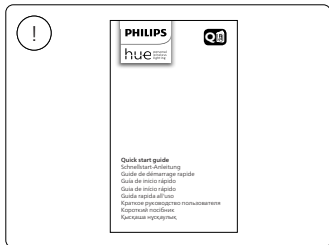



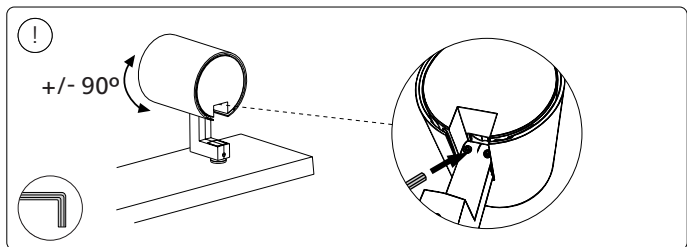
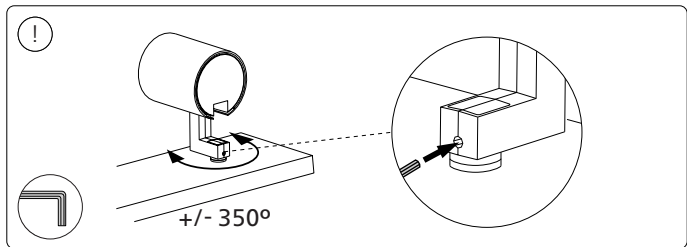

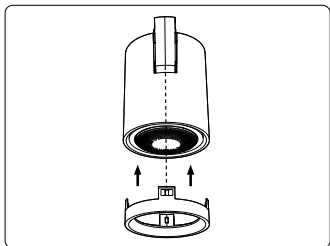
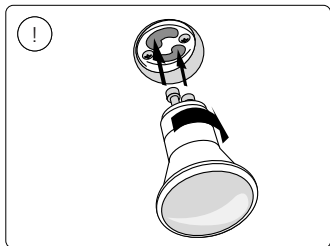
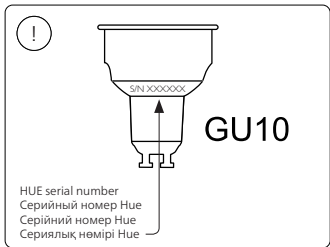
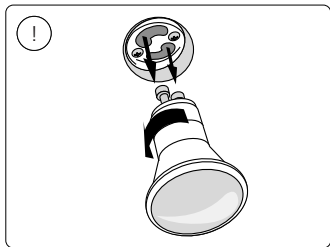
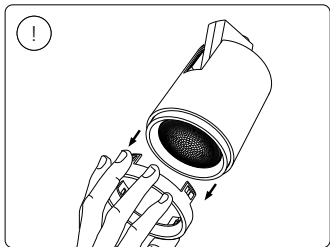





Signify  
I.B.R.S. / C.C.R.I. Numéro 10461  
5600 VB Eindhoven,  
the Netherlands  
☎00800-74454775

© 2022 Signify Holding  
All rights reserved

[www.philips-hue.com](http://www.philips-hue.com)

4404 029 12673

Last update: 01/2022

915005928101 Centris Hue 2-spot black

915005928301 Centris Hue 2-spot white