

# PHILIPS

Calgary

9150060029



User manual  
Benutzerhandbuch  
Notice d'emploi  
Manual de usuario  
Manual do usuário  
Manuale d'uso  
Gebruiksaanwijzing

Incl.



Excl.

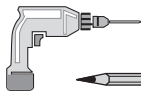

IPX4

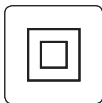
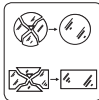

3/8"

8mm

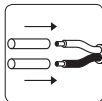

E27



MAX. 60 W

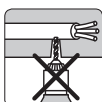
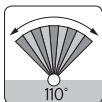
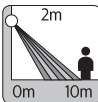
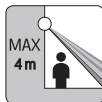

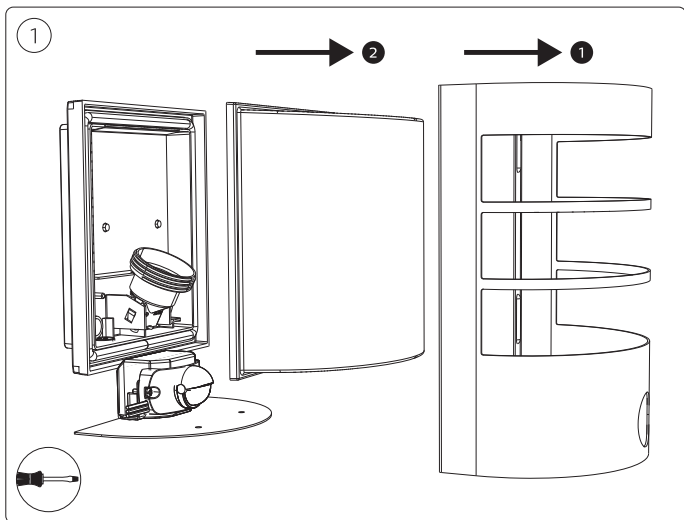
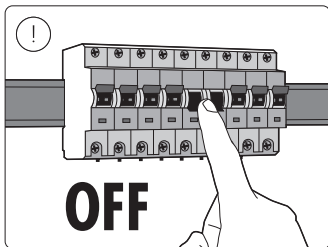
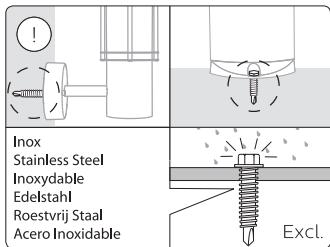

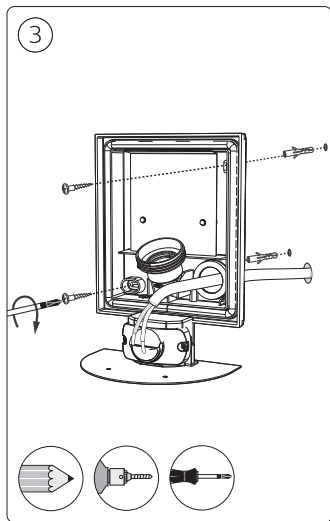
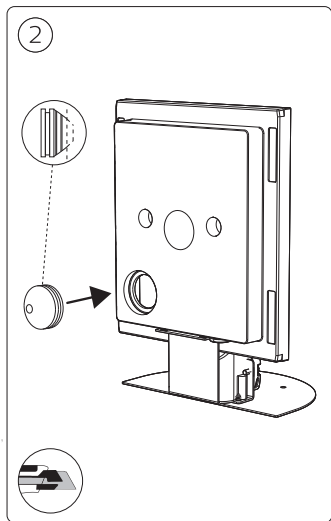

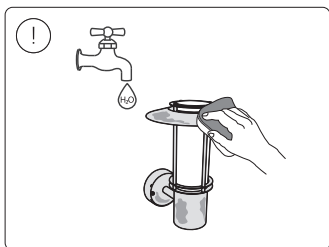
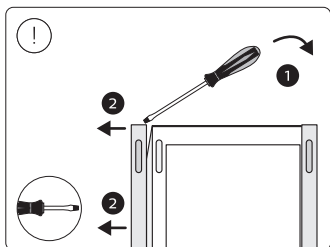
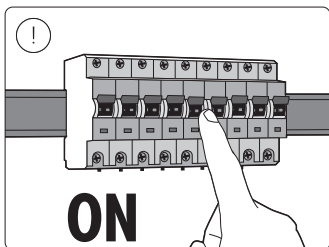
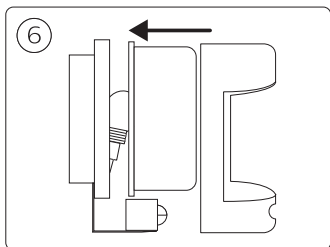
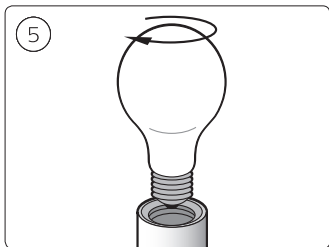
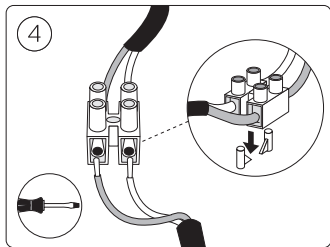

7a

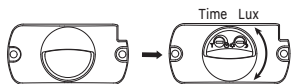

7b Time



5 Sec  $\pm$  2 Sec



12 Min  $\pm$  3 Min



7c Lux

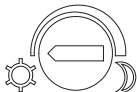

< 200Lux



< 30Lux





Signify Commercial UK Limited  
Unit 3, Guildford Business Park,  
Guildford, Surrey, GU2 8XG, UK

Signify  
I.B.R.S. / C.C.R.I. Numéro 10461  
5600 VB Eindhoven, the Netherlands  
☎00800-74454775

Philips and the Philips Shield Emblem  
are registered trademarks of Koninklijke  
Philips N.V. and are used under license.

[www.philips.com/lighting](http://www.philips.com/lighting)

© 2024 Signify Holding  
Signify

4404 017 67623