

PHILIPS

hue personal wireless lighting

Festavia string lights 100 / 250 LEDs



User manual  
Benutzerhandbuch  
Notice d'emploi  
Manual de usuario  
Manual do usuário  
Manuale d'uso

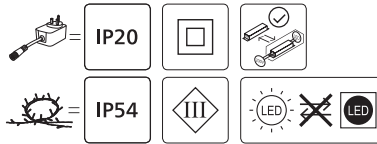
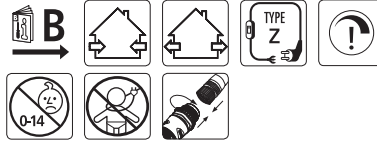
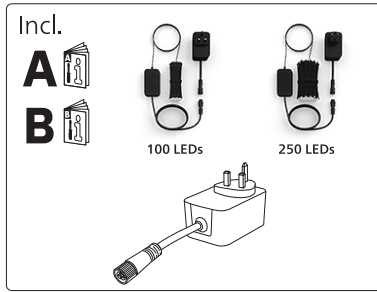

2

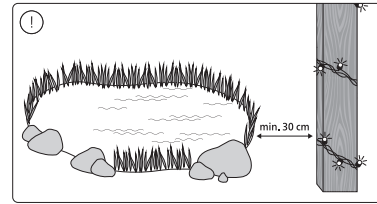
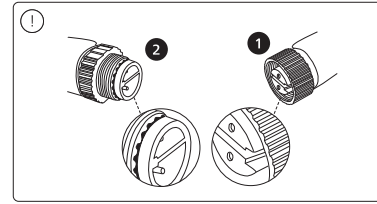
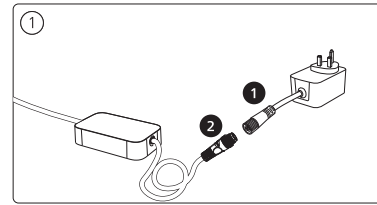

3



Signify  
I.B.R.S. / C.C.R.I. Numéro 10461  
5600 VB Eindhoven,  
the Netherlands  
00800-74454775

www.philips-hue.com  
442296205502

© 2024 Signify Holding  
All rights reserved  
Last update: 01/2024

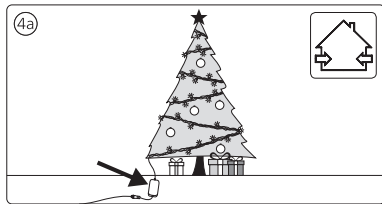
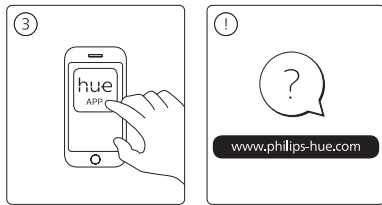
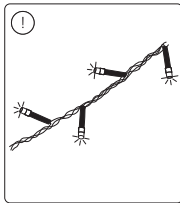
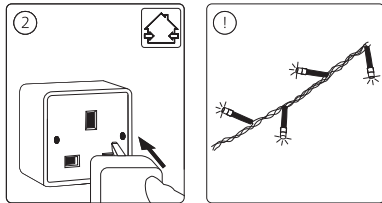

4

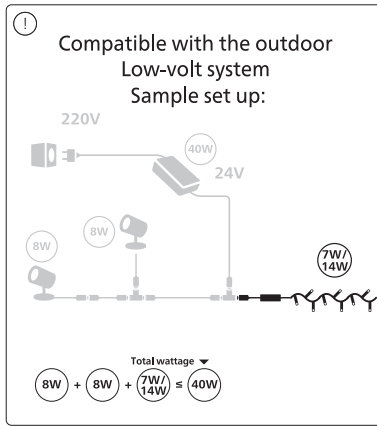
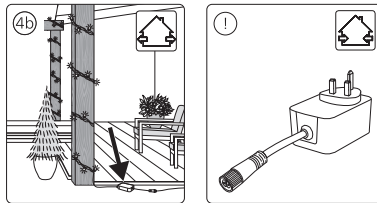

5

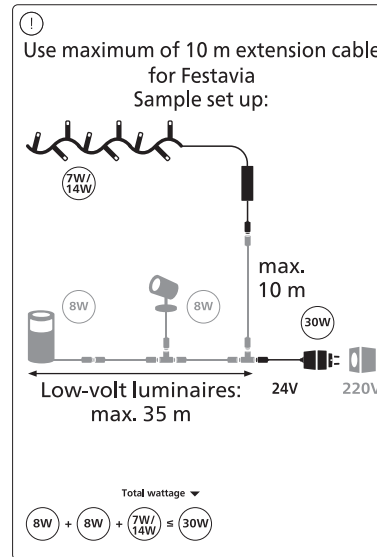

6

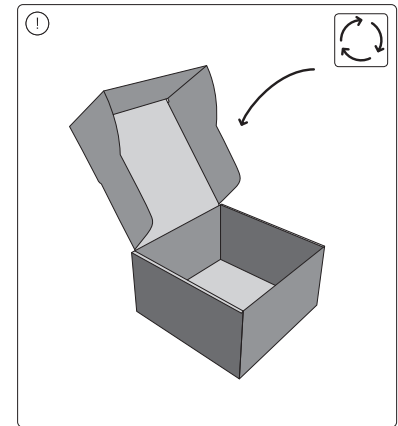
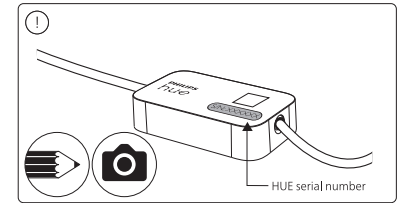

7