

PHILIPS

hue personal wireless lighting

Festavia string lights 500 LEDs



User manual
Benutzerhandbuch
Notice d'emploi
Manual de usuario
Manual do usuário
Manuale d'uso

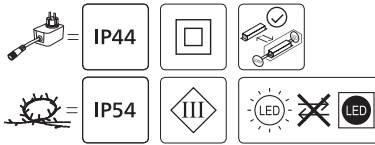
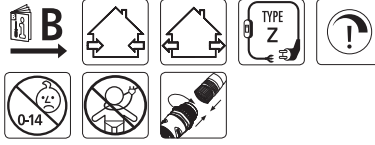
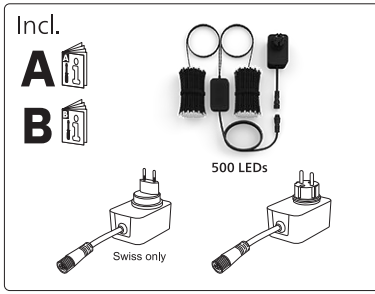

2

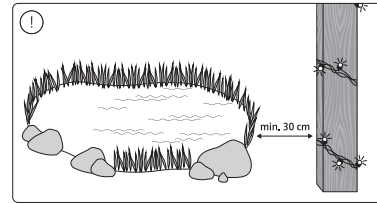
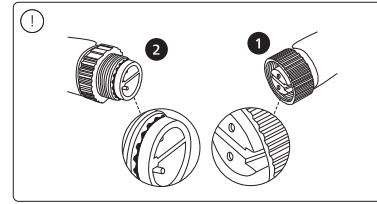
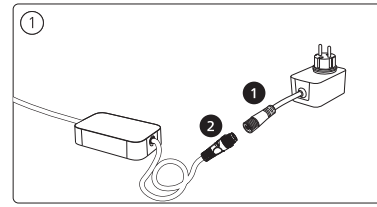

3



Signify
I.B.R.S. / C.C.R.I. Numéro 10461
5600 VB Eindhoven,
the Netherlands
00800-74454775

© 2024 Signify Holding
All rights reserved
Last update: 01/2024

www.philips-hue.com
442296206322

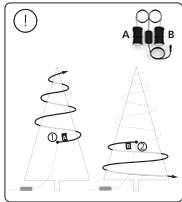
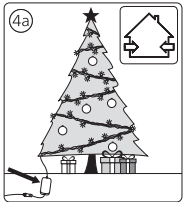
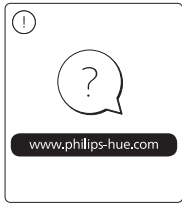
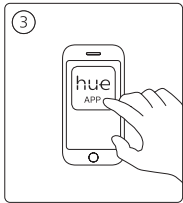
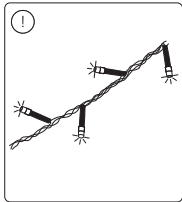
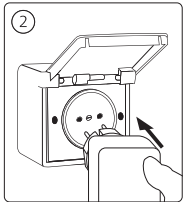

4

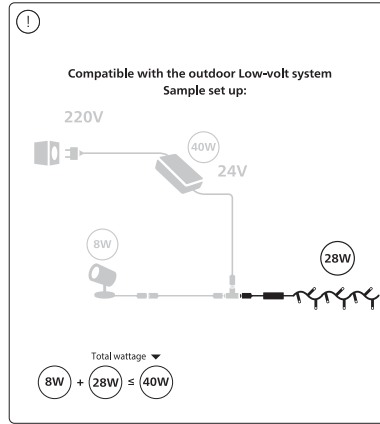
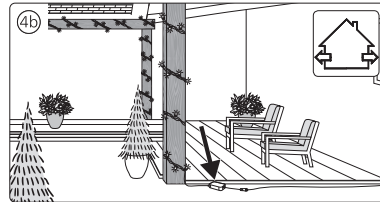

5

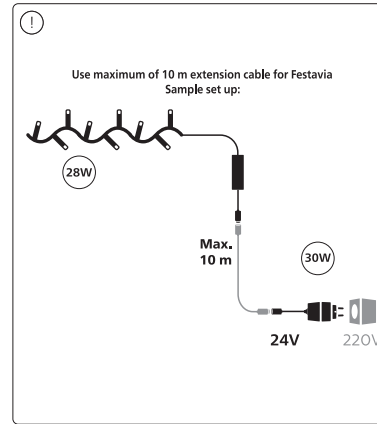

6

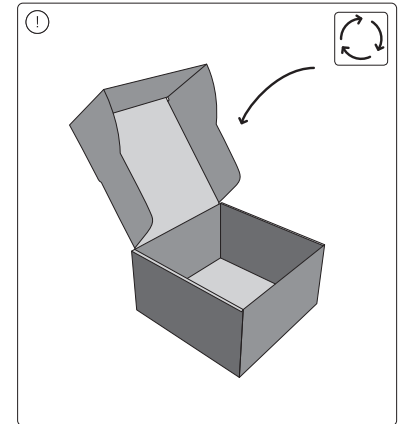
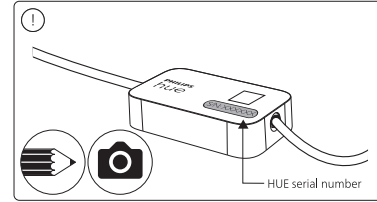

7