

PHILIPS

Bustan Ultra Efficient
9290033453
9290033454



User manual
Benutzerhandbuch
Notice d'emploi
Manual de usuario
Manual do usuário
Manuale d'uso
Gebruiksaanwijzing

Incl.

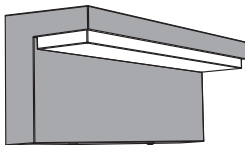

x2

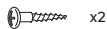

x2

ST4.2*30mm

Excl.

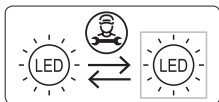
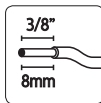
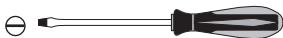
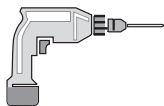

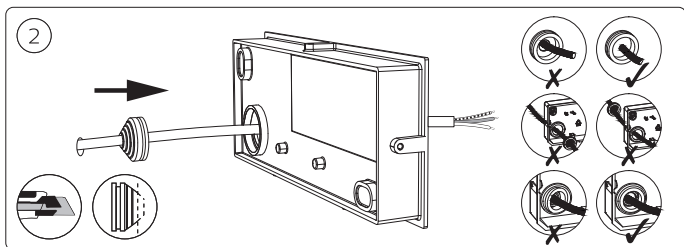
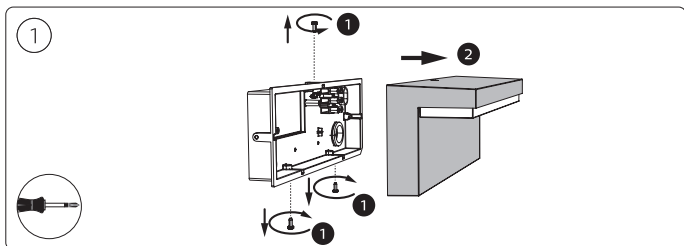
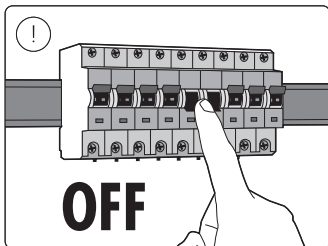
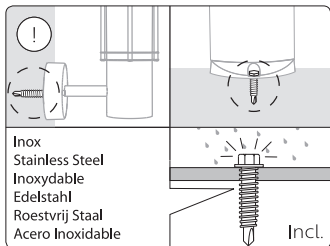

3

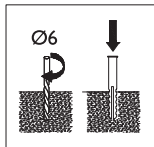
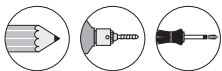
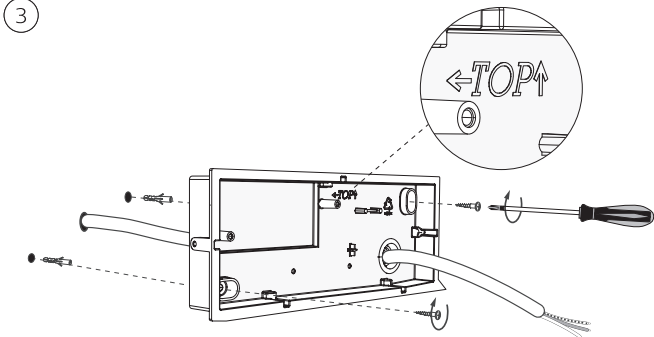

4

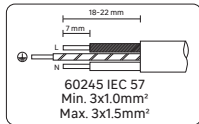
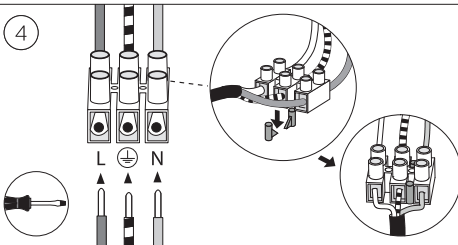

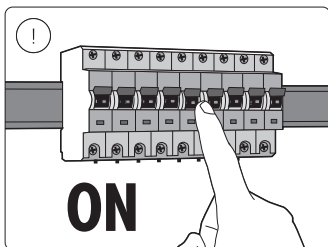
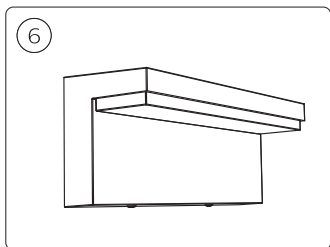
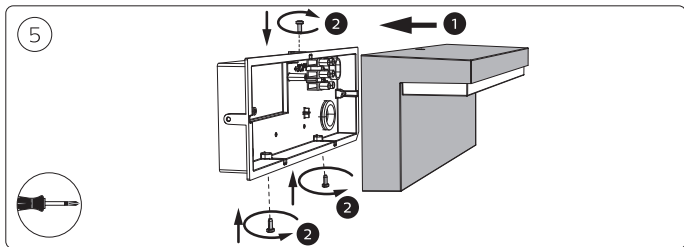



Signify Commercial UK Limited
Unit 3, Guildford Business Park,
Guildford, Surrey, GU2 8XG, UK

Signify
I.B.R.S. / C.C.R.I. Numéro 10461
5600 VB Eindhoven,
the Netherlands
☎00800-74454775

Philips and the Philips Shield Emblem are registered trademarks
of Koninklijke Philips N.V. and are used under license

3241 660 88532
www.philips.com/lighting

© 2024 Signify Holding

signify