

PHILIPS

Nysil
9290040737



User manual
Benutzerhandbuch
Notice d'emploi
Manual de usuario
Manual do usuário
Manuale d'uso
Gebruiksaanwijzing

Incl.

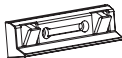
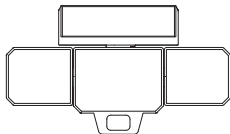

Excl.

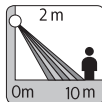
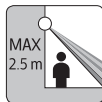
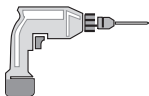

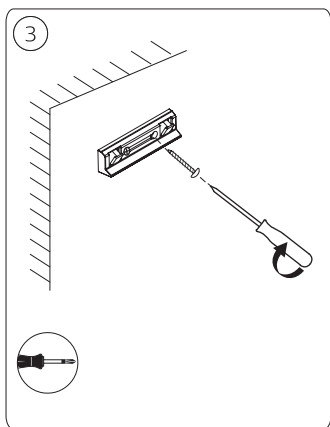
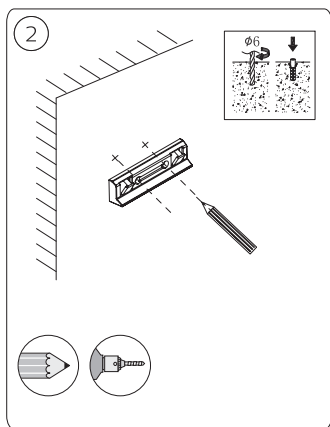
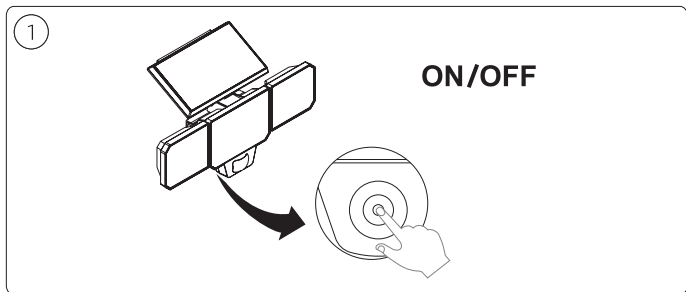

4

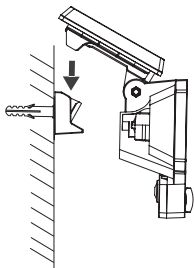

5

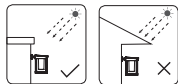
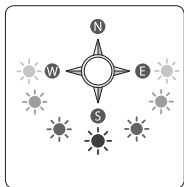
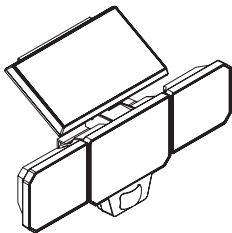

! Battery replacement

1

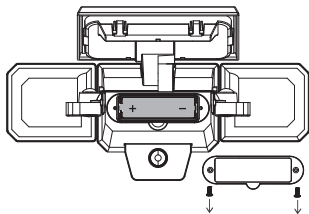

2

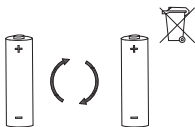

18650/3.6-3.7V Li-ion/Min2000mAh
(Length ≤ 67.5mm)

3

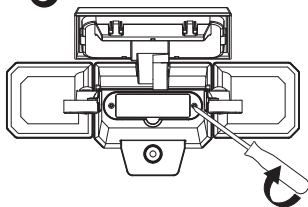



Signify Commercial UK Limited
Unit 3, Guildford Business Park,
Guildford, Surrey, GU2 8XG, UK

Signify
I.B.R.S. / C.C.R.I. Numéro 10461
5600 VB Eindhoven,
the Netherlands
☎00800-74454775

Philips and the Philips Shield Emblem
are registered trademarks of Koninklijke
Philips N.V. and are used under license.

www.philips.com/lighting

© 2024 Signify Holding
Signify

3241 661 00203