

# PHILIPS

Petronia Ultra Efficient  
9290040807

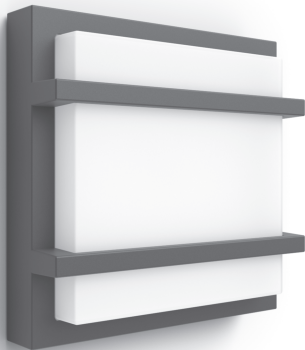

User manual  
Benutzerhandbuch  
Notice d'emploi  
Manual de usuario  
Manual do usuário  
Manuale d'uso  
Gebruiksaanwijzing

Incl.

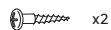
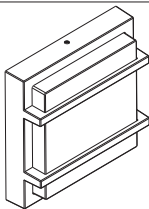

ST4.2\*30mm

Excl.

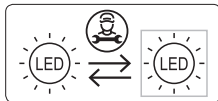
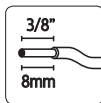
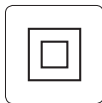
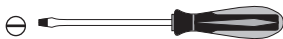
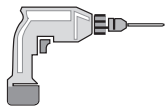

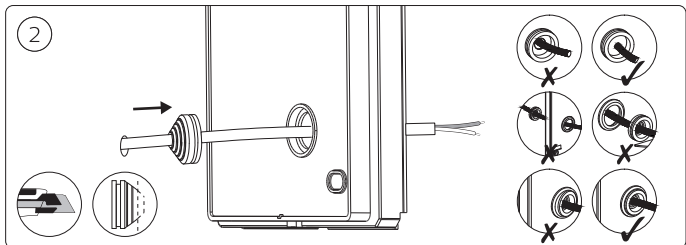
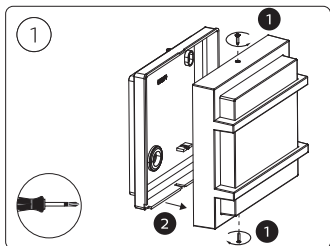
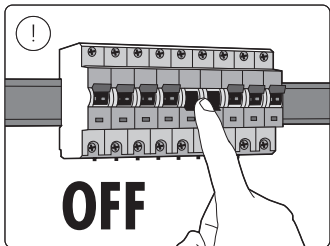
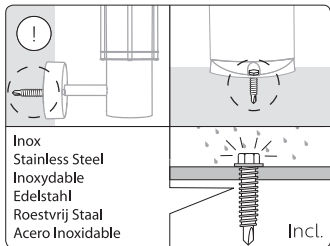

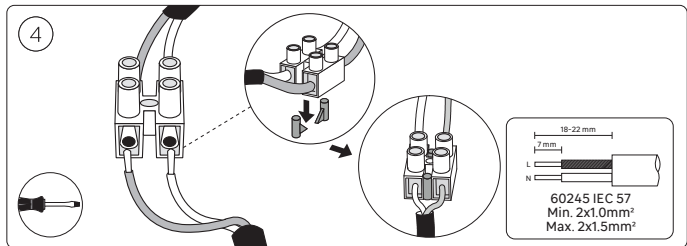
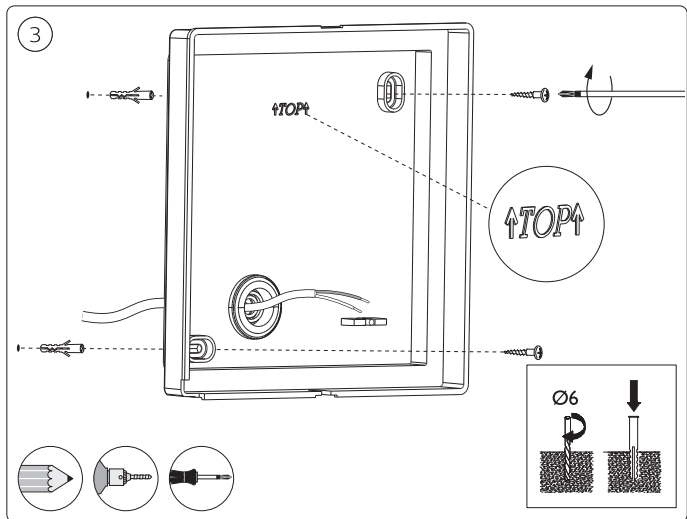

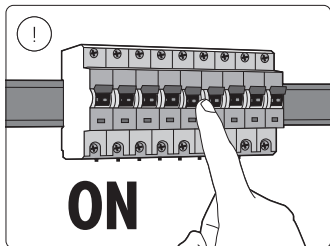
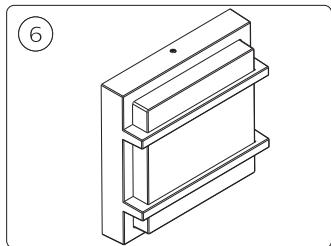
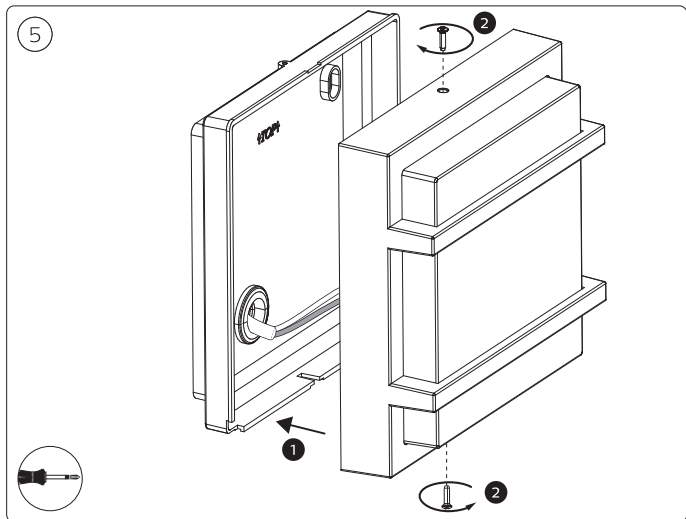



Signify Commercial UK Limited  
Unit 3, Guildford Business Park,  
Guildford, Surrey, GU2 8XG, UK

Signify  
I.B.R.S. / C.C.R.I. Numéro 10461  
5600 VB Eindhoven,  
the Netherlands  
☎00800-74454775

Philips and the Philips Shield Emblem are registered trademarks  
of Koninklijke Philips N.V. and are used under license

3241 660 93112  
[www.philips.com/lighting](http://www.philips.com/lighting)

© 2024 Signify Holding

signify