

PHILIPS

Kyna
9290047043



User manual
Benutzerhandbuch
Notice d'emploi
Manual de usuario
Manual do usuário
Manuale d'uso
Gebruiksaanwijzing

Incl.



Excl.

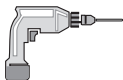

09

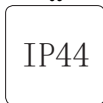

13



36

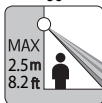

37

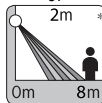

38

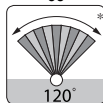

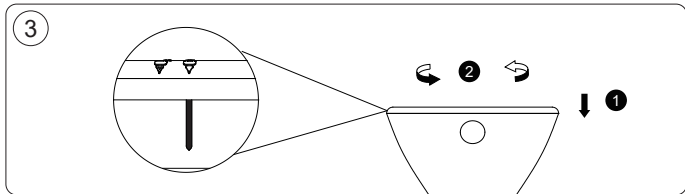
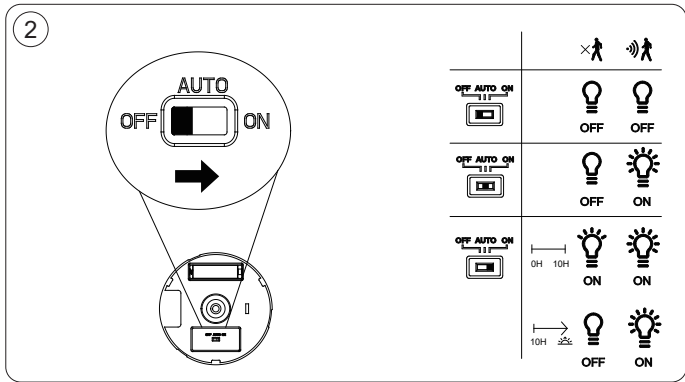
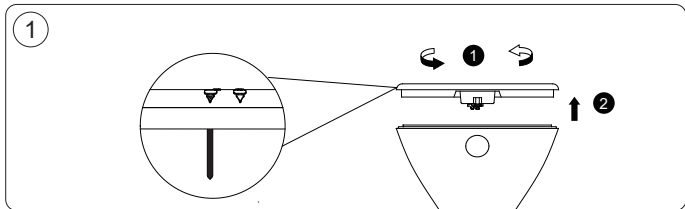

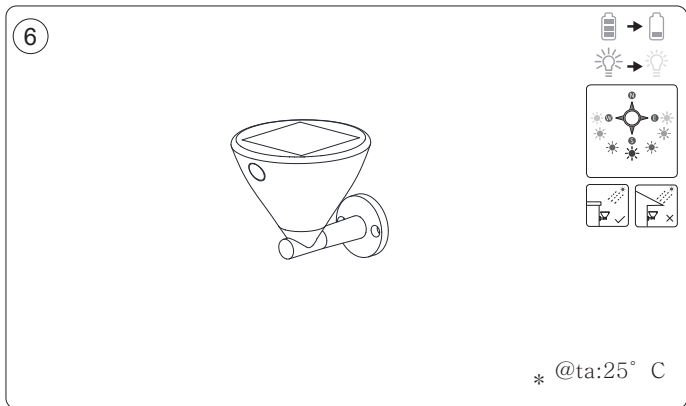
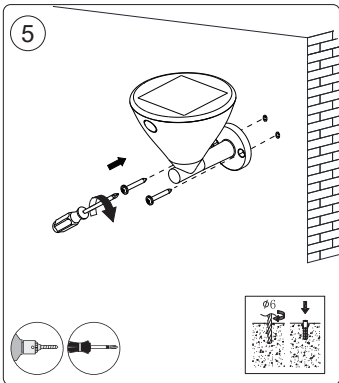
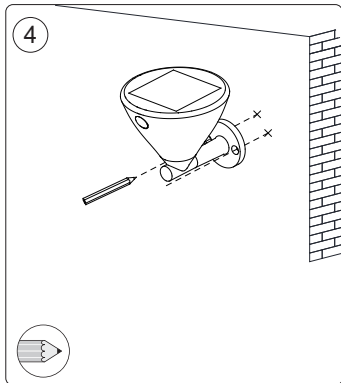

Replace Battery

1

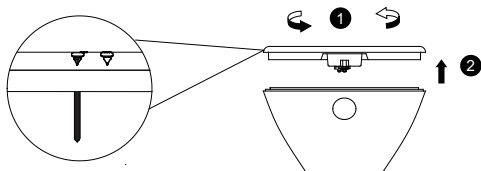

2

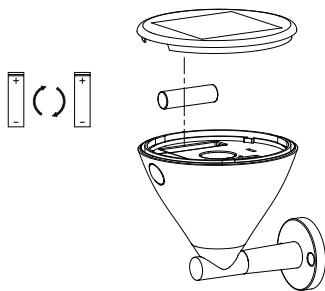

14500/3.7V Li-ion/MIN800mAh

3

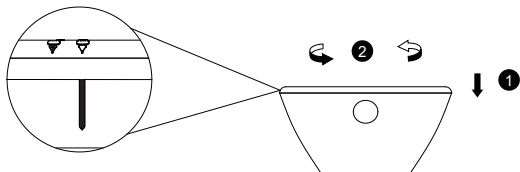



Signify Commercial UK Limited
2 Guildford Business Park,
GU2 8XG

Signify
I.B.R.S. / C.C.R.I. Numéro 10461
5600 VB Eindhoven,
the Netherlands
☎00800-74454775

© 2025 Signify Holding

ignify

Philips and the Philips Shield Emblem
are registered trademarks of Koninklijke
Philips N.V. and are used under license

www.philips.com/lighting

3241 663 02131