



DynaVision Programmable Xtreme for SON

HID-DV PROG Xt 50 SON Q 208-277V

Highly reliable and flexible electronic drivers for SON lamps; designed to save energy via integrated controls, and to reduce maintenance costs thanks to 80,000-hour lifetime and integrated lightning protection. The DynaVision Programmable product family is the perfect basis for any sort of lighting management solution.

Product data

Operating and Electrical	
Input Voltage	208-240-277 V
Line Frequency	50 to 60 Hz
Input frequency	50 to 60 Hz
Earth leakage current (max.)	0.7 mA
Inrush current width	0.24 ms
Input current (nom.)	0.27 A
Inrush current peak (nom.)	28 A
Number of products on MCB (16 A type B) (nom.)	11
Surge Protection (Common/Differential)	EN61547 (L-L 2 kV, L-G 4 kV), 10 kV TIL
Wiring	
Cable length from device to lamp	10 m
Connector type	WAGO series 804

Temperature	
T-case lifetime (nom.)	80 °C
Controls and Dimming	
Control interface	PROG
Mechanical and Housing	
Housing	Q
Net Weight (Piece)	0.820 kg
Approval and Application	
Safety standard	IEC 607, 609, 926, 928 [No Standard for HID Lamp drivers exists. Requirements in these standards to be used if considered relevant for the product.]
Environmental standard	ISO 14001
Approval marks	F-Marking CE marking ENEC certificate VDE-EMV certificate

DynaVision Programmable Xtreme for SON

CE mark	Yes
Ambient temperature range	-30°C to 55°C
Product Data	
Order product name	HID-DV PROG Xt 50 SON Q 208-277V
Full product name	HID-DV PROG Xt 50 SON Q 208-277V
Full EOC	871829166924100
Order code	913700693366

Material no. (12 NC)	913700693366
Local order code	DVPROGXT50SONQ
Numerator – quantity per pack	1
EAN/UPC – Product/Case	8718291669241
Numerator – packs per outer box	12
EAN/UPC - Case	8718291669258

Dimensional drawing

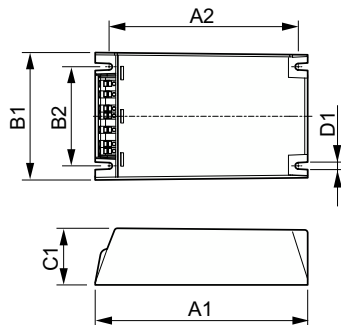

Product	D1	C1	A1	A2	B1	B2
HID-DV PROG Xt 50 SON Q 208-277V	4.5 mm	40.0 mm	150.0 mm	133.6 mm	90.0 mm	70.0 mm

