

# ADVANCE

by  Signify

## T8 LED Driver

Mark 7 0-10V

IZT-4P16-TLED-SC



### IZT-4P16-TLED-SC

Brand Name	Mark 7 0-10V
Driver Type	Electronic Dimming
Lamp Connection	Parallel
Input Voltage	120-277V
Input Frequency	50/60 Hz
Status	Active



### Specifications

Description	Product No.	Model No.	Ordering Code	Bare Lamp Watts (W)	Nom. Initial Lumens	Min. Start Temp (°F/°C)	Num. of Lamps	Input Current @ Max Output (A)	Input Power (Min/Max) (W)	THD% @ Max Output	Power Factor @ Max Output
Philips LED InstantFit T8 - 4' MasterClass	565580	9290030253/A	8.9T8/MAS/48-830/IF15/P/DIM 10/1	8.9	1500	-13/-25	4	0.43/0.19	6 / 50	10	0.99/0.97
	565598	9290030254/A	8.9T8/MAS/48-835/IF15/P/DIM 10/1		1500						
	565606	9290030255/A	8.9T8/MAS/48-840/IF16/P/DIM 10/1		1600						
	565614	9290030256/A	8.9T8/MAS/48-850/IF16/P/DIM 10/1		1600						
	473974	9290020158A	9.5T8/MAS/48-830/IF15/P 10/1	9.5	1500	-13/-25	4	0.45/0.20	6 / 54	10	0.98/0.93
	473982	9290020159A	9.5T8/MAS/48-835/IF15/P 10/1		1500						
	473990	9290020160A	9.5T8/MAS/48-840/IF16/P 10/1		1600						
	474007	9290020161A	9.5T8/MAS/48-850/IF16/P 10/1		1600						
	473974	9290020158	9.5T8/MAS/48-830/IF15/P 10/1	9.5	1500	-13/-25	4	0.45/0.20	6 / 54	10	0.99/0.97
	473982	9290020159	9.5T8/MAS/48-835/IF15/P 10/1		1500						
473990	9290020160	9.5T8/MAS/48-840/IF16/P 10/1	1600								
474007	9290020161	9.5T8/MAS/48-850/IF16/P 10/1	1600								
Philips LED Instant-Fit T8 - 4' CorePro	553214	9290022527A	10T8/COR/48-830/IF15/G 10/1	10	1500	-13/-25	4	0.51/0.22	6 / 61	10	0.99/0.97
	553222	9290022528A	10T8/COR/48-835/IF15/G 10/1		1500						
	553230	9290019917A	10T8/COR/48-840/IF16/G 10/1		1600						
	553248	9290019918A	10T8/COR/48-850/IF16/G 10/1		1600						
Philips LED InstantFit T8 - 4' High Output MasterClass	473926	9290013976E/F	13T8/MAS/48-830/IF20/P/DIM 10/1	13	2000	-13/-25	4	0.62/0.27	7 / 73	10	0.99/0.98
	473934	9290013977E/F	13T8/MAS/48-835/IF20/P/DIM 10/1		2000						
	473942	9290013978E/F	13T8/MAS/48-840/IF21/P/DIM 10/1		2100						
	473958	9290013979E/F	13T8/MAS/48-850/IF21/P/DIM 10/1		2100						
	473926	9290013976A/B	13T8/MAS/48-830/IF20/P/DIM 10/1	13	2000	-13/-25	4	0.56/0.24	6 / 66	10	0.99/0.97
	473934	9290013977A/B	13T8/MAS/48-835/IF20/P/DIM 10/1		2000						
	473942	9290013978B/D	13T8/MAS/48-840/IF21/P/DIM 10/1		2100						
	473958	9290013979A/B	13T8/MAS/48-850/IF21/P/DIM 10/1		2100						
	473926	9290013976	13T8/48-3000 IF 10/1 HO	13	2000	-13/-25	4	0.60/0.26	6 / 70	10	0.99/0.98
	473934	9290013977	13T8/48-3500 IF 10/1 HO		2000						
	473942	9290013978	13T8/48-4000 IF 10/1 HO		2100						
	473958	9290013979	13T8/48-5000 IF 10/1 HO		2100						
	468306	9290011585C	14T8/48-3000 IF 10/1 HO	14	2000	-13/-25	4	0.58/0.25	6 / 68	10	0.99/0.98
	468314	9290011586C	14T8/48-3500 IF 10/1 HO		2000						
	468322	9290011587C	14T8/48-4000 IF 10/1 HO		2100						
	468330	9290011588C	14T8/48-5000 IF 10/1 HO		2100						

# Mark 7 0-10V IZT-4P16-TLED-SC

## IZT-4P16-TLED-SC

Brand Name	Mark 7 0-10V
Driver Type	Electronic Dimming
Lamp Connection	Parallel
Input Voltage	120-277V
Input Frequency	50/60 Hz
Status	Active

## Specifications

Description	Product No.	Model No.	Ordering Code	Bare Lamp Watts (W)	Nom. Initial Lumens	Min. Start Temp (°F/°C)	Num. of Lamps	Input Current @ Max Output (A)	Input Power (Min/Max) (W)	THD% @ Max Output	Power Factor @ Max Output
Philips LED InstantFit T8 - 4' High Output CorePro	470096	9290013430B	14T8/COR/48-830/IF20/G 10/1	14	2000	-13/-25	4	0.53/0.23	6 / 63	10	0.99/0.97
	470104	9290013431B	14T8/COR/48-835/IF20/G 10/1		2000						
	470112	9290013432B	14T8/COR/48-840/IF21/G 10/1		2100						
	470120	9290013433B	14T8/COR/48-850/IF21/G 10/1		2100						
Philips LED InstantFit T8 - 4' Ultra High Output MasterClass	545178	9290020162C	15.5T8/MAS/48-830/IF23/P/DIM 25/1	15.5	2300	-13/-25	4	0.67/0.29	4 / 79	10	0.99/0.98
	533372	9290020163C	15.5T8/MAS/48-835/IF24/P/DIM 25/1		2400						
	545194	9290020164C	15.5T8/MAS/48-840/IF25/P/DIM 25/1		2500						
	545200	9290020165C	15.5T8/MAS/48-850/IF25/P/DIM 25/1		2500						
	545178	9290020162B	15.5T8/MAS/48-830/IF23/P/DIM 25/1	15.5	2300	-13/-25	4	0.67/0.29	7 / 78	10	0.99/0.98
	533372	9290020163B	15.5T8/MAS/48-835/IF24/P/DIM 25/1		2400						
	545194	9290020164B	15.5T8/MAS/48-840/IF25/P/DIM 25/1		2500						
	545200	9290020165B	15.5T8/MAS/48-850/IF25/P/DIM 25/1		2500						
	533372	9290020163A	15.5T8/MAS/48-835/IF24/P 25/1	15.5	2400	-13/-25	4	0.62/0.27	7 / 70	10	0.99/0.97
	545194	9290020164A	15.5T8/MAS/48-840/IF25/P 25/1		2500						
	545200	9290020165A	15.5T8/MAS/48-850/IF25/P 25/1		2500						
	545178	9290020162	15.5T8/MAS/48-830/IF23/P 10/1	15.5	2300	-13/-25	4	0.62/0.27	7 / 73	10	0.99/0.97
533372	9290020163	15.5T8/MAS/48-835/IF24/P 10/1	2400								
545194	9290020164	15.5T8/MAS/48-840/IF25/P 10/1	2500								
545200	9290020165	15.5T8/MAS/48-850/IF25/P 10/1	2500								
468892	9290013044	16.5T8 LED/48-3000 IF 10/1 HO	16.5	2300	-13/-25	4	0.70/0.30	6 / 84-83	10	0.99/0.99	
463133	9290012267	16.5T8 LED/48-3500 IF 10/1 HO		2400							
463141	9290012268	16.5T8 LED/48-4000 IF 10/1 HO		2500							
463158	9290012269	16.5T8 LED/48-5000 IF 10/1 HO		2500							
Philips LED InstantFit T8 - 3' MasterClass	539858	9290019675B/D	8.5T8/MAS/36-830/IF13/P/DIM 10/1	8.5	1300	-13/-25	4	0.40/0.18	6 / 47	10	0.99/0.96
	539866	9290019679B/D	8.5T8/MAS/36-835/IF13/P/DIM 10/1		1300						
	539874	9290019676B/D	8.5T8/MAS/36-840/IF14/P/DIM 10/1		1400						
	539882	9290019677B/D	8.5T8/MAS/36-850/IF14/P/DIM 10/1		1400						
	539858	9290019675A	8.5T8/MAS/36-830/IF13/P 10/1	8.5	1300	-13/-25	4	0.38/0.17	6 / 46	10	0.99/0.96
	539866	9290019679A	8.5T8/MAS/36-835/IF13/P 10/1		1300						
	539874	9290019676A	8.5T8/MAS/36-840/IF14/P 10/1		1400						
	539882	9290019677A	8.5T8/MAS/36-850/IF14/P 10/1		1400						
	539858	9290019675	8.5T8/MAS/36-830/IF13/P 10/1	8.5	1300	-13/-25	4	0.39/0.17	6 / 46	10	0.99/0.96
	539866	9290019679	8.5T8/MAS/36-835/IF13/P 10/1		1300						
	539874	9290019676	8.5T8/MAS/36-840/IF14/P 10/1		1400						
	539882	9290019677	8.5T8/MAS/36-850/IF14/P 10/1		1400						

# Mark 7 0-10V IZT-4P16-TLED-SC

## Enclosure

	In. (cm)
Case Width (W)	1.7 (4.3)
Case Height (H)	1.18 (3.0)
Mounting Length (M)	8.90 (22.6)
Overall Length (L1)	9.5 (24.1)

## Wiring Diagram

	In. (cm)
Black	24 (61)
White	24 (61)
Blue	28 (71.1)
Red	28 (71.1)
Yellow	43 (109.2)

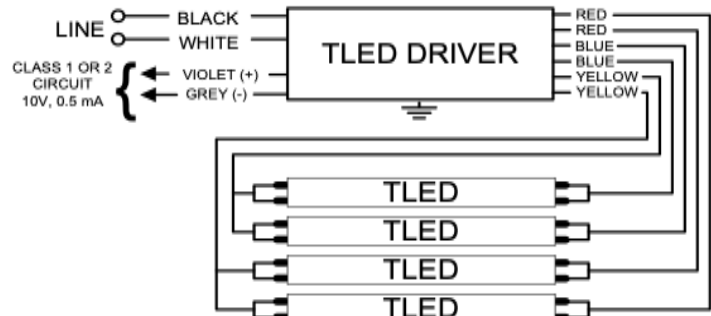
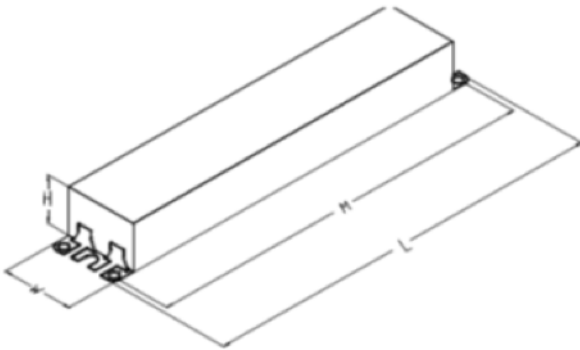

\*FOR THREE LAMP OPERATION,  
INSULATE UNUSED BLUE OR RED LEAD FOR 600V

# Mark 7 0-10V IZT-4P16-TLED-SC

## IZT-4P16-TLED-SC

Brand Name	Mark 7 0-10V
Driver Type	Electronic Dimming
Lamp Connection	Parallel
Input Voltage	120-277V
Input Frequency	50/60 Hz
Status	Active

## Electrical Specifications

### Section I - Physical Characteristics

- 1.1 Driver shall be physically interchangeable with standard electromagnetic or standard electronic ballasts, where applicable.
- 1.2 Driver shall be provided with integral leads color coded per ANSI C82.11.

### Section II - Performance Requirements

- 2.1 Driver shall energize compatible LED lamps within 1 second after mains power is applied.
- 2.2 Driver shall provide Independent Lamp Operation (ILO) allowing remaining lamp(s) to maintain full light output when one or more lamps fail.
- 2.3 Driver shall contain auto restart circuitry in order to restart lamps without resetting power.
- 2.4 Driver shall operate from a 50Hz or 60 Hz AC input source of 120V through 277V with sustained variations of +/- 10% (voltage and frequency).
- 2.5 Driver shall be high frequency electronic type and operate lamps at frequencies above 42 kHz to avoid interference with infrared devices and eliminate visible flicker.
- 2.6 Driver shall have a Power Factor of 0.94 or above when operating the maximum rated number of compatible lamps, and 0.89 or above when operating the minimum rated number of compatible lamps.
- 2.7 Driver input current shall Total Harmonic Distortion (THD) of 10% or less when operating the maximum rated number of compatible lamps and 15% or less when operating the minimum rated number of compatible lamps.
- 2.8 Driver shall have a Class A sound rating.
- 2.9 Driver shall have a minimum starting temperature of -13°F / -25°C.
- 2.10 Driver shall tolerate sustained open circuit and short circuit output conditions.
- 2.11 Driver shall be capable of operating lamps remotely and in tandem for wire lengths up to 20 ft.
- 2.12 Driver shall be suitable of operation in up to a 45°C ambient temperature.

### Section III - Regulatory Requirements

- 3.1 Driver shall not contain any Polychlorinated Biphenyl (PCB).
- 3.2 Driver shall be Underwriters Laboratories (UL) Recognized with Both UL and CSA Standards, and suitable for Damp and Dry conditions.
- 3.3 Driver shall comply with ANSI C62.41 Category A Transient protection.
- 3.4 Driver shall comply with the requirements of the Federal Communication Commission (FCC) rules and regulations, Title 47, CFR part 15, Non-Consumer (Class A) for EMI/RFI (conducted and radiated).
- 3.5 Driver shall comply with NEMA 410 for in-rush current limits.

### Section IV - Other

- 4.1 Driver shall be manufactured in a factory certified to ISO 9001 Quality System Standards.
- 4.2 Driver shall carry a five year warranty from date of manufacture against defects in material and workmanship when operating in a 45°C ambient environment or less.

