

PHILIPS

hue

**Wired wall switch
module**



User manual

Benutzerhandbuch

Notice d'emploi

Manual de usuario

Manual do usuário

Manuale d'uso

Table of contents

• Important purchase and installation tips	3
• General safety instructions	4
• Installation instructions	6
• What's in the box	7
• Rocker switch – 1 way	8
• Rocker switch variants	10
• Rocker switch – 2 gang	11
• Push-in wire connector usage	13
• Push buttons	14
• Technical data	15
• Having trouble with your device?	16

Important purchase and installation tips

Before purchase

- Examine how your light switch is installed to determine if the Hue wired wall switch module will work and function properly with your type of light switch.

 Attention! Always make sure your circuit breaker is off before removing the light switch plate.

- Determine if there is enough room in your electrical box to install the Hue wired wall switch module. The Hue wired wall switch module measures 41 mm x 37.3 mm x 15 mm (width x depth x height).
- Watch tutorial videos and/or read documentation of the light switch from the manufacturer to determine if your light switch is suitable.

-  * Requires Hue bridge and only compatible with Hue light sources
- * The product needs a neutral wire to be available

Before installation

Attention! Electrical devices may only be installed and connected by electrically skilled persons.

- For safe installation, commissioning, and operation, read the installation and legal guide before use.
- Always switch off the circuit breaker before any assembly or maintenance.
- Ensure no one switches on the circuit breaker during assembly or disassembly.
- Cover up any live wires.

During installation

- Take a photo of the original light switches' wiring before removing them. Original wires from your home's electricity will be terminated with a wire connector.
- Scan the QR code on the manual or product before installation - then complete the onboarding on the Hue app after installation is done.

After installation

- Even a lamp that is switched off is permanently supplied with mains voltage. When replacing a light source, turn off the circuit breaker.
- Before any maintenance on your light switch, make sure to turn off the circuit breaker.

 **Attention! Consult an electrician for support when in doubt.**

General safety instructions

For your safety



DANGER HAZARD OF ELECTRIC SHOCK

Safe electrical installation must be carried out with proven knowledge in the following areas:

- Connecting installation networks
- Connecting electrical devices
- Handling electric cables
- Safety standards, local wiring rules and regulations



DANGER! Electrical shocks when live parts are touched can be fatal.

- Prepare well, take your time, and avoid distraction
- Use the right equipment to do the installation
- Keep children on a safe distance from any installation and maintenance work

Note: when one of the above points are not met, do not proceed and consult an electrician or local authority for guidance.



Application notes for installers, how-to-video, and FAQ's can be found on our support page.

General safety instructions



EN Work on electrical installations is, in some countries, only allowed by a qualified electrician. For support contact a local electrician or authority.

DE Die Arbeit an Elektroinstallationen ist in einigen Ländern nur qualifizierten Elektrikern gestattet. Wenden Sie sich zur Unterstützung an einen Elektriker oder eine Behörde vor Ort.

FR Dans certains pays, les travaux sur les installations électriques ne peuvent être effectués que par des électriciens qualifiés. Pour toute demande d'assistance, veuillez contacter un électricien ou votre autorité locale.

ES En algunos países, únicamente los electricistas cualificados pueden trabajar en instalaciones eléctricas. Si necesitas asistencia, ponte en contacto con la autoridad o con un electricista local.

PT In alcuni paesi, solo gli elettricisti qualificati possono svolgere lavori relativi alle installazioni elettriche. Per informazioni, contatta il tuo elettricista di fiducia oppure l'autorità preposta.

IT Em alguns países, apenas os eletricistas qualificados podem realizar trabalho em instalações elétricas. Para obter assistência, contacte um eletricista ou uma autoridade local.



EN The electrical circuit and attached light source will always be powered after installation. Turn off the circuit when replacing a light fixture.

DE Der Stromkreis und die angeschlossene Lichtquelle werden nach der Installation immer mit Strom versorgt. Schalten Sie daher den Stromkreis aus, wenn Sie eine Leuchte.

FR Le circuit électrique et la source lumineuse raccordée seront toujours alimentés après l'installation. Par conséquent, mettez le circuit hors tension lors du remplacement d'un luminaire.

ES Tras la instalación, el circuito eléctrico y la fuente de luz conectada siempre tendrán alimentación eléctrica. Apaga el circuito cuando cambies una luminaria.

PT Dopo l'installazione, il circuito elettrico e la sorgente luminosa collegata rimangono sempre alimentati. Spegni il circuito per sostituire l'apparecchio per illuminazione.

IT O circuito elétrico e a fonte de luz associada estarão sempre ligados à alimentação após a instalação. Quando substituir um equipamento de luz desligue o circuito.

Installation instructions

- **!** Attention! Electrical devices may only be mounted and connected by electrically skilled persons.
- For safe installation, commissioning, and operation, the instruction and legal manual with the product must be read.
- Before any assembly or disassembly always switch off the circuit breaker.

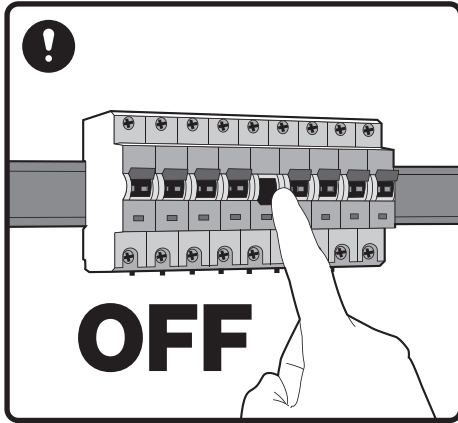

- Always make sure nobody can switch on the circuit breaker while working
 - It is advised to check that there is no voltage, ground, and shortcut on any parts
 - Cover up live wires
 - Test that the power is off before proceeding
- !** Only proceed when above is checked.
Advice: print this manual and cross off the above steps to ensure a safe working environment.

What's in the box

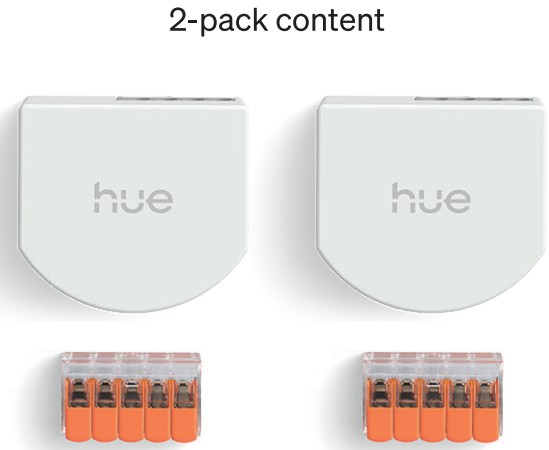
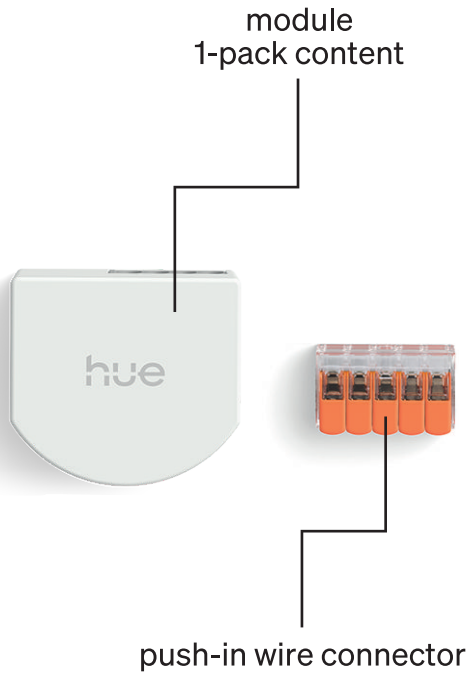

Excluded elements

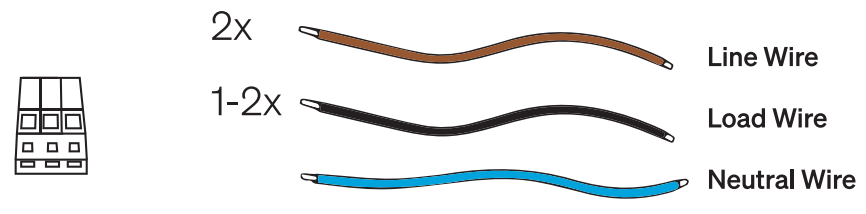
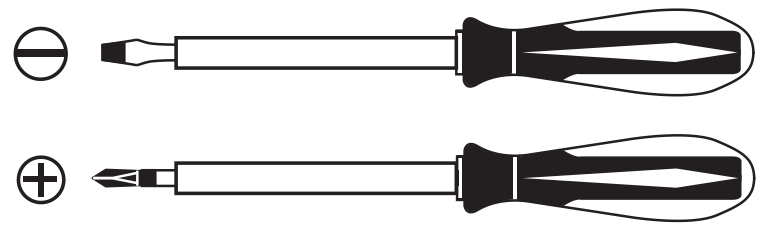

Rocker switch 1-way

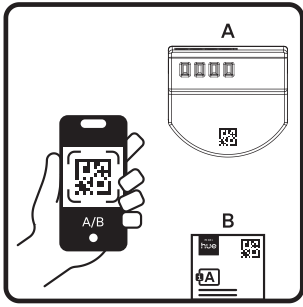

1. Scan the QR code and follow the steps in the Hue app

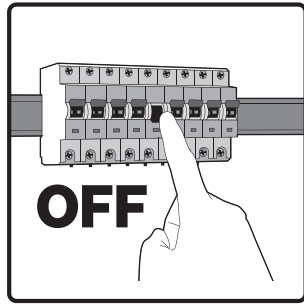

2. Always switch off power before you start

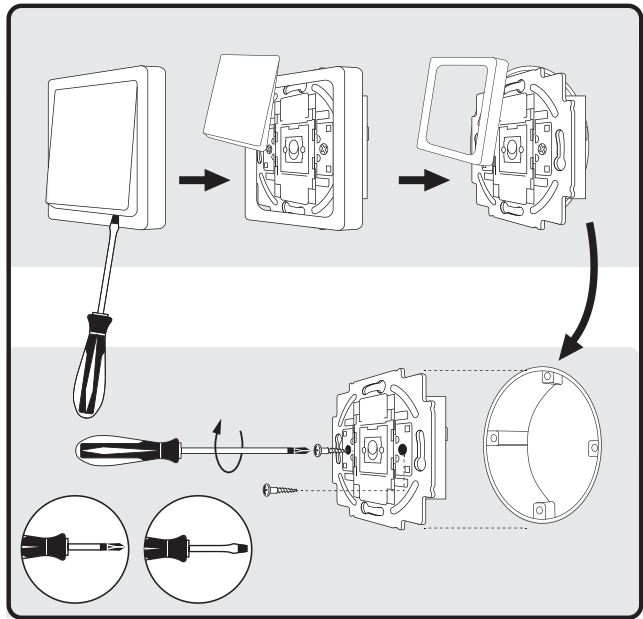

3. Remove the switch to access the wiring

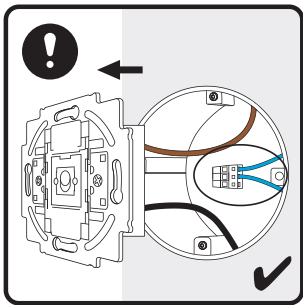

4. Make sure there is a neutral wire in the wall box

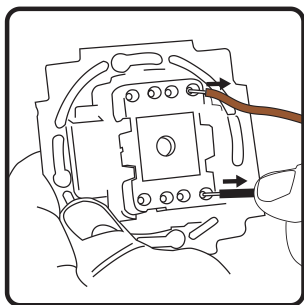

5. Disconnect the load wire and the line wire

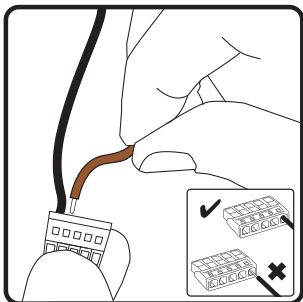

6. Connect the load wire and the line wire to the push-in connector

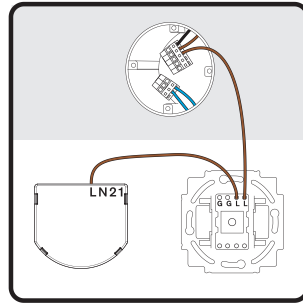

7. Place a new line wire between L terminal and the switch

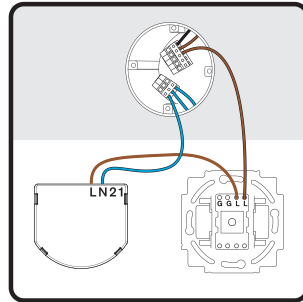

8. Place a new line wire between the switch and the additional connector

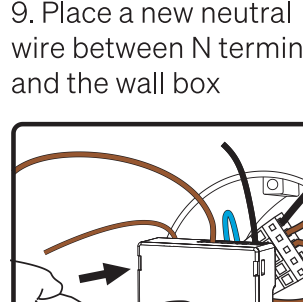

9. Place a new neutral wire between N terminal and the wall box

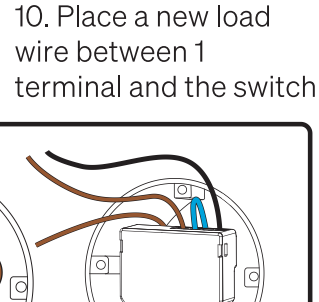

10. Place a new load wire between 1 terminal and the switch

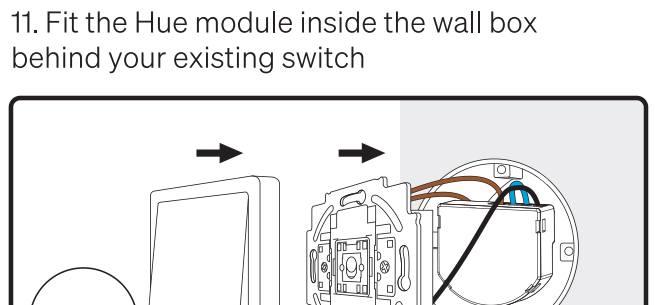

11. Fit the Hue module inside the wall box behind your existing switch

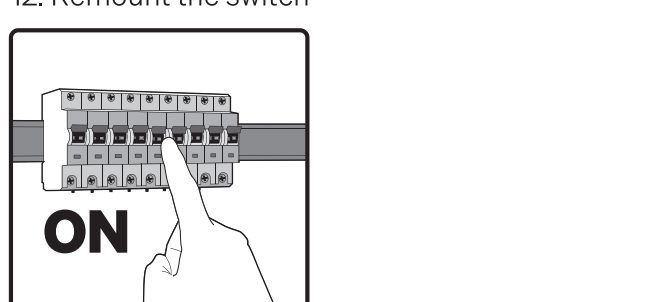

12. Remount the switch

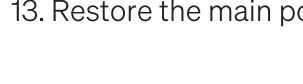

13. Restore the main power

Rocker switch 1-way

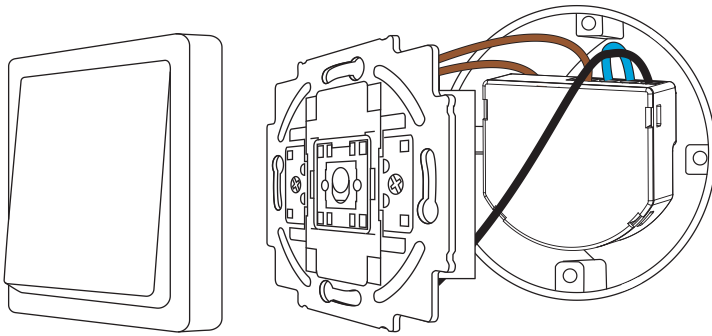

! Keep the app open until the product is fully installed and you are guided to the next screen. If needed, please re-scan the QR code on the manual.

- 1-way switching using a rocker type switch is the default for the Hue wall switch module in the Hue app.
- This installation is for connecting a single legacy switch to a Hue module to keep Hue lights reachable.
- For circuit diagrams please review the application notes on our FAQ page.
- In most cases only the 2 disconnected (live) wires and the new line wire must be placed in the provided push-in wire connector.

Tip! Take a picture before removing the wires to remember the location.

- When adding the module in the Hue app, follow the instructions and select first “One button” and then “Rocker switch” when asked.

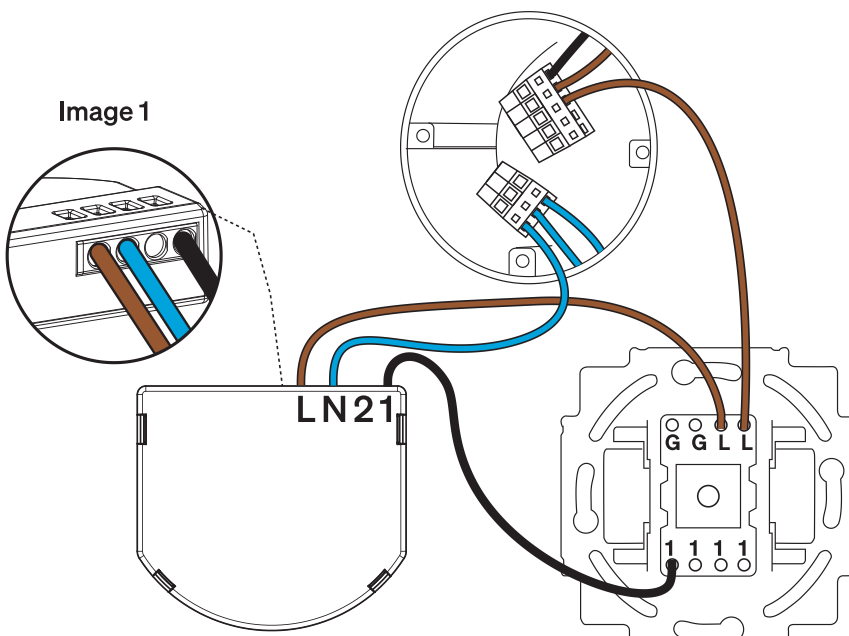

- For 2-way switching please follow Application notes. In the app, follow the same installation steps for the wall module as regular 1-way switching and select “One button” and “Rocker switch” for both modules when asked.
- For other switching set ups please follow the Application notes available on our support page.

Rocker switch variants

- A rocker light switch typically has two positions, On and Off, and works like a seesaw.
- We support 1 gang and 2 gang rocker switches per wall switch module.

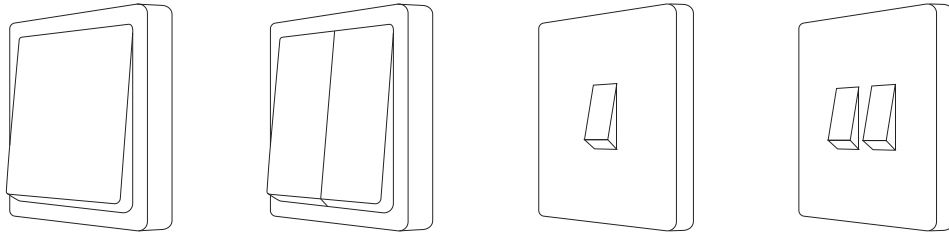

- There are many variances of light switches and the module works with most common switch types with the following exceptions:
 - The module does not work in combination with dimmers and dimming modules.

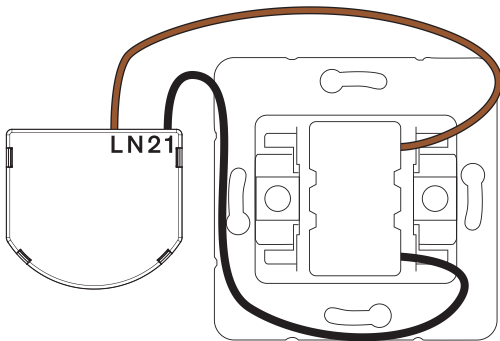

Standard switch with side mounting

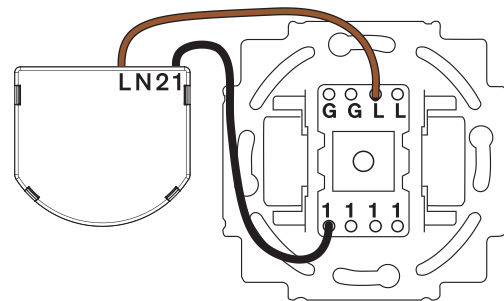

Standard switch with backside mounting

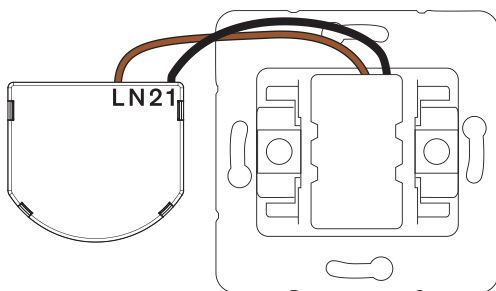

Standard switch with top mounted wires

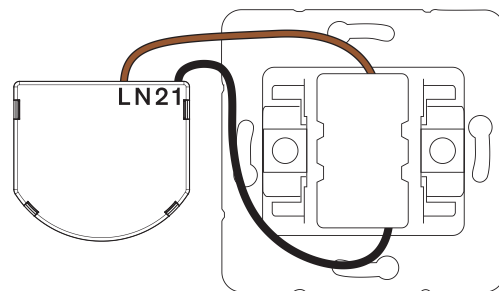

Standard switch with top and bottom mounted wires

- If in doubt whether your switch is suitable for installation, contact an electrician for support.

Rocker switch 2-gang

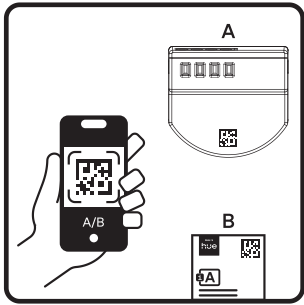

1. Scan the QR code and follow the steps in the Hue app

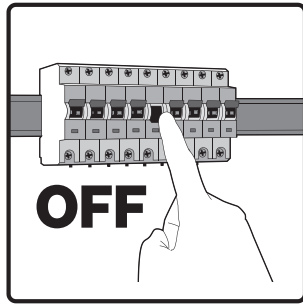

2. Always switch off power before you start

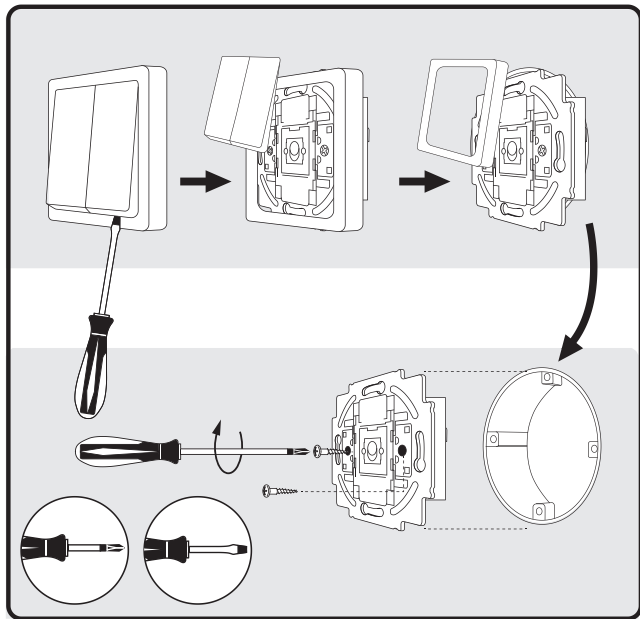

3. Remove the switch to access the wiring

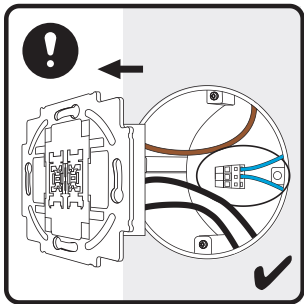

4. Make sure there is a neutral wire in the wall box

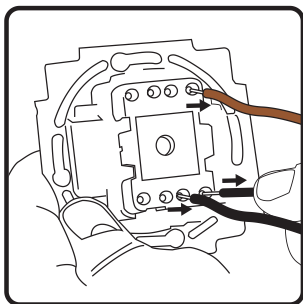

5. Disconnect the load wire and the line wire

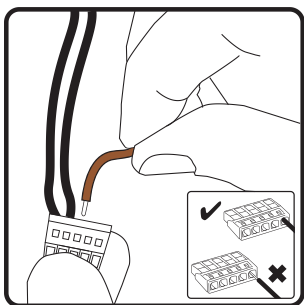

6. Connect the load wire and the line wire to the push-in connector

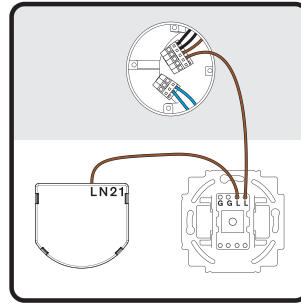

7. Place a new line wire between L terminal and the switch

8. Place a new line wire between the switch and the additional connector

9. Place a new neutral wire between N terminal and the wall box

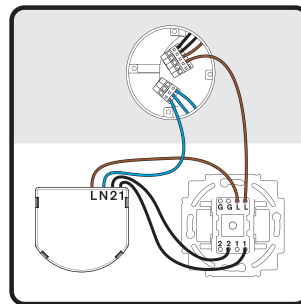
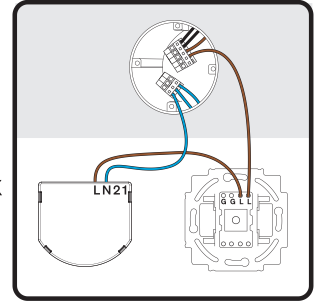

10. Place a new load wire between 1 terminal and the switch

11. Place a new load wire between 2 terminal and switch

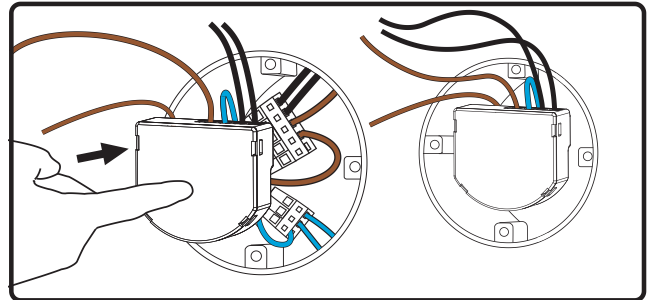

12. Fit the Hue module inside the wall box behind your existing switch

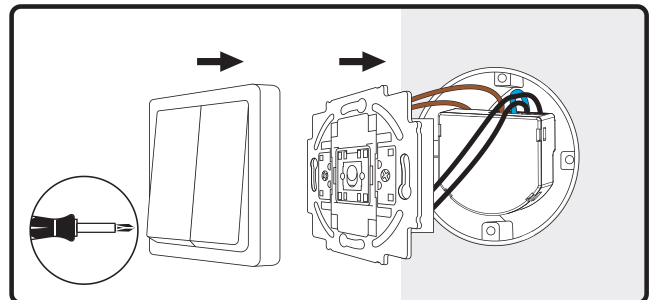

13. Remount the switch

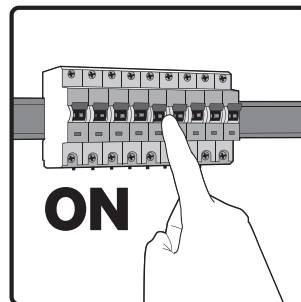

14. Restore the main power

Rocker switch 2-gang

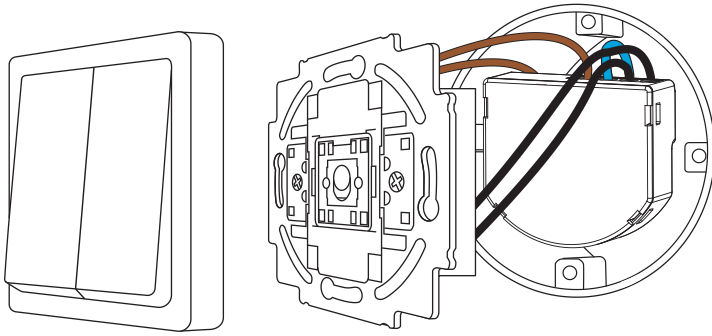

- ! Keep the app open until the product is fully installed and you are guided to the next screen.
 - This installation is for two switches in one frame, controlling two independent groups of lights.
 - For circuit diagrams please review the application notes on our FAQ page.
- In most cases only the 3 disconnected (live) wires and the new line wire have to be added to the provided push-in wire connector. Never add neutral and/or ground to the push-in wire connector.
Tip! Take a picture before removing the wires to remember the location.
 - You need to use two sets of wiring, one in position 1 and one in position 2 (see image 1) in the module.

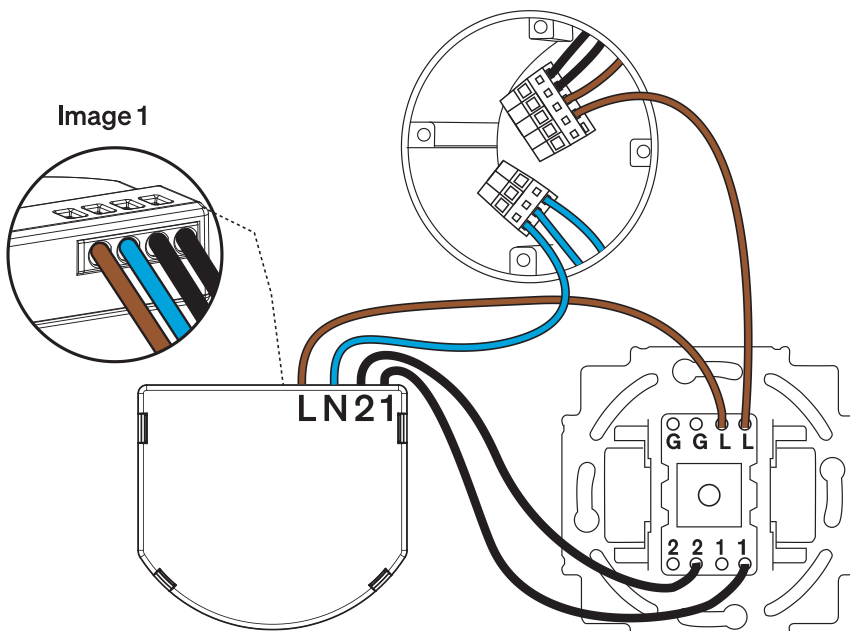

- When adding the module in the Hue app, follow the instructions and select first "Two button" and then "Rocker switch" when asked.

Push-in wire connector instructions

1. Select the right (live) wires
Attention! Do not add neutral or ground wires to the push-in wire connector
 2. Straighten the wires (cut when necessary to straighten the wires)
 3. Make sure the copper part can be fully inserted into the connector
 4. Push the wires into the connector until they are locked securely in place
- Attention!
- No copper should be outside the connector.
 - Stranded wires should not be used with the provided connector. (see image 1)
 - Choose an appropriate connector for stranded wires (not provided).

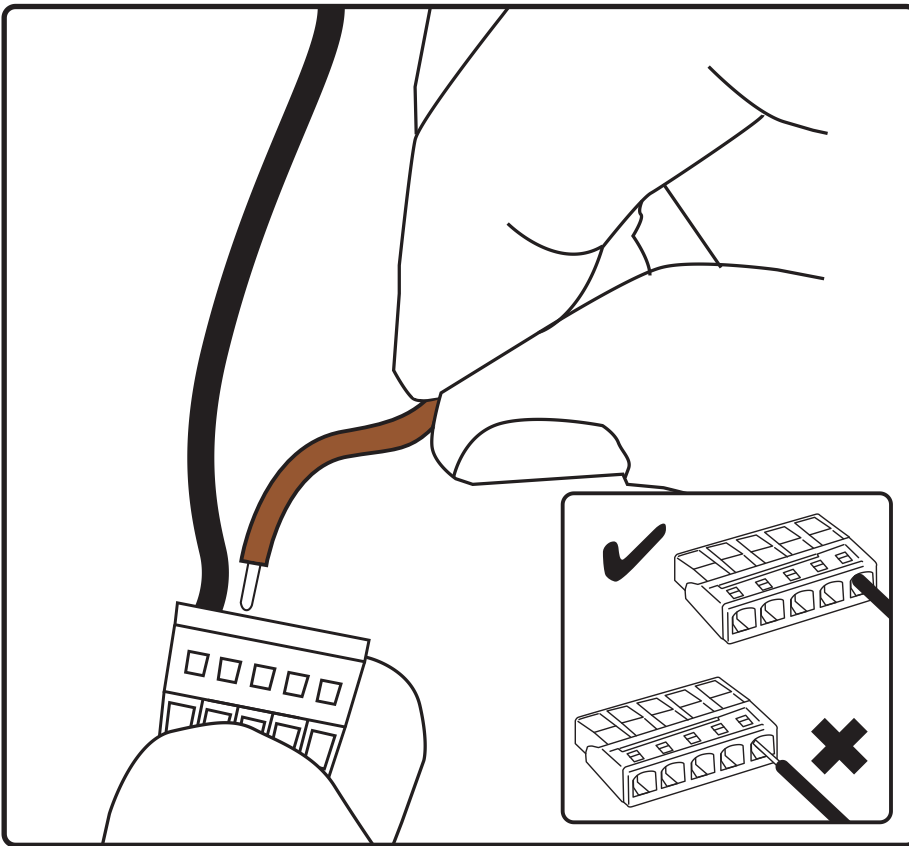

Image 1

The suitable wire size and strip length for the 5-terminal push-in connector provided in the box:



Conductor cross section:

Solid: 0,75 to 4 mm²

Conductor stripped length:

11 mm

Push buttons

- A push button switch returns to a neutral position directly after being pushed, by means of a spring inside the switch, which is not the case for rocker switches that work like a seesaw.
- From appearance these could sometimes look very similar to rocker switches or dimmers.
- A push button can not be turned to dim but could sometimes look very similar to a dimmer because of its round shape.

❗ When it is determined a push button is used, please select single or double push button during the configuration in the app.

Users will be asked in the app to indicate whether their switches have one or two push buttons, and will help them in identifying via animations if unclear.

❗ Keep the app open until the product is fully installed and you are guided to the next screen.

Technical data

Rated voltage	220-240V
Ambient temperature	-5 ... +45 C
Storage temperature	-5 ... +45 C
Transportation temperature	-20 ... +70 C
Communication protocol	Zigbee 3.0
Radio frequency	2.400 ... 2.483 GHz
Transmission power	max 10mW
Dimensions	41 x 37.3 x 15 mm

The suitable wire size and strip length for the terminal blocks in the wired wall switch module

Conductor cross section:	Solid: 0,75 to 2,5 mm ²
Conductor stripped length:	9 ... 10 mm

The suitable wire size and strip length for the push-in connector provided

Conductor cross section:	Solid: 0,75 to 4 mm ²
Conductor stripped length:	11 mm

In the case a wire is inserted in the wrong terminal on the module, there is a way to disconnect the wire from the terminal. Insert a screwdriver in the slot and push slightly to release the wire.

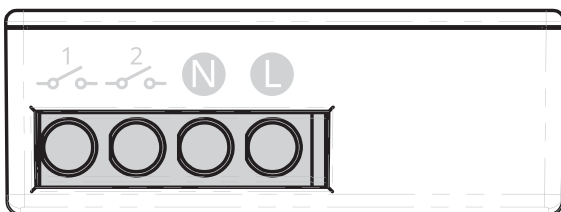

Having trouble with your device?

- Check whether button presses are reported in the Hue app (either in the room they are in or in Settings > Devices > Switches). If the app is not registering that the button is being pressed, it could be an indication that there is a wireless connectivity problem.
- Check third-party and partner integrations for any settings that could interfere with the settings you chose in the Hue app.
- Reset in app. This will allow you to reconfigure the device from scratch, without needing to recommission it.
- This device may be set up as a rocker or push button. If that does not match the type of switch you have placed it behind, please delete this device from the Hue app and re-add it.
- Turn your power completely off via the circuit breaker. Check the cables connected to your switch. Ensure that each cable is wired through the correct terminal in the module.
- Delete the device from your Bridge in the app, then re-add it and configure it as normal. You can find the QR code on the product and manual. If your wall switch module is not connecting, you may use the 6-character set up code found on the product instead.



hue

Signify

I.B.R.S. / C.C.R.I. Numéro 10461
5600 VB Eindhoven,
the Netherlands
00800-74454775

© 2026 Signify Holding

Last update: 04/2026

www.philips-hue.com

322263916711

