

interact

# Interact Application Guide

for office, education, healthcare, retail  
and industrial applications

This is all you need for your smart lighting system

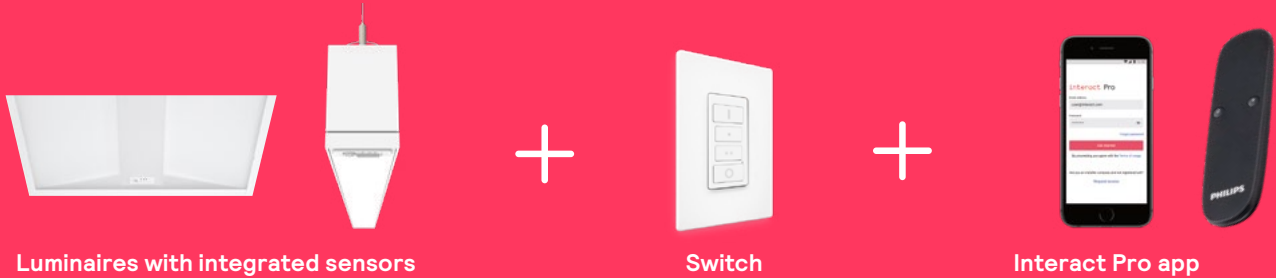

Luminares with integrated sensors

Switch

Interact Pro app

Office lighting needs to facilitate the day-to-day life of people. It must provide a great visual comfort and ambiance, without consuming more energy than needed. The Interact system was developed to deliver high quality, instant-on light that saves energy, is easy to install and future proof.

- Ideal for refurbishment and new buildings – no additional control wires needed
- Fast Installation – after mounting of luminaire and controls, the system is ready to use in a few clicks
- High flexibility – customization of the system is possible at any time
- Perfect for every project size – no light point restrictions
- No additional cost – system configuration via free Interact Pro App
- No local customer IT-Network integration needed – commissioning via smartphone app and Bluetooth
- Upgrade possible at any moment by simply adding a gateway to access additional benefits such as connection of multiple user devices and analytics dashboard.

# Interact for office, education, healthcare, retail and industrial applications architecture

## Add on devices for Enterprise features

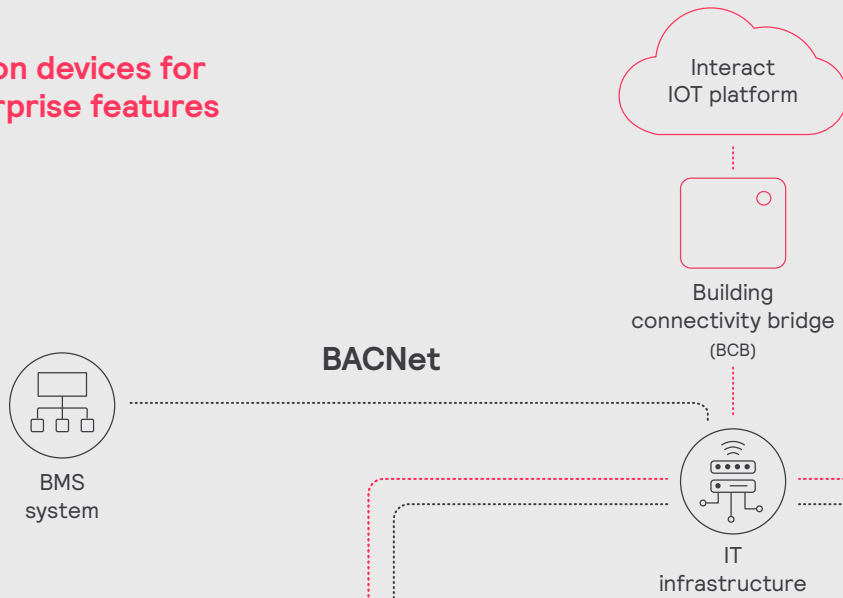

## Add on devices for Advanced features

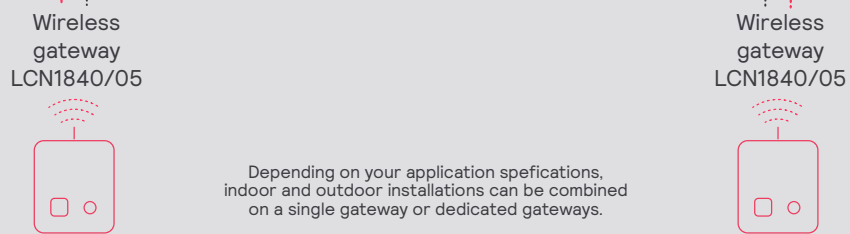

## Foundation building blocks

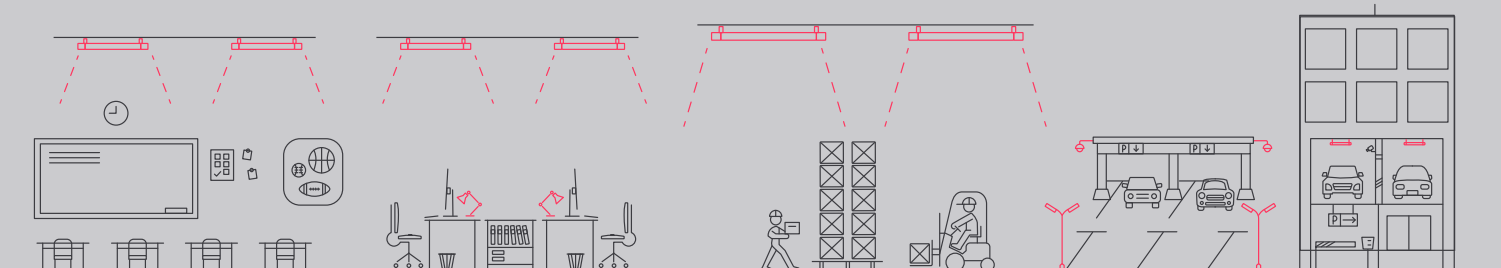
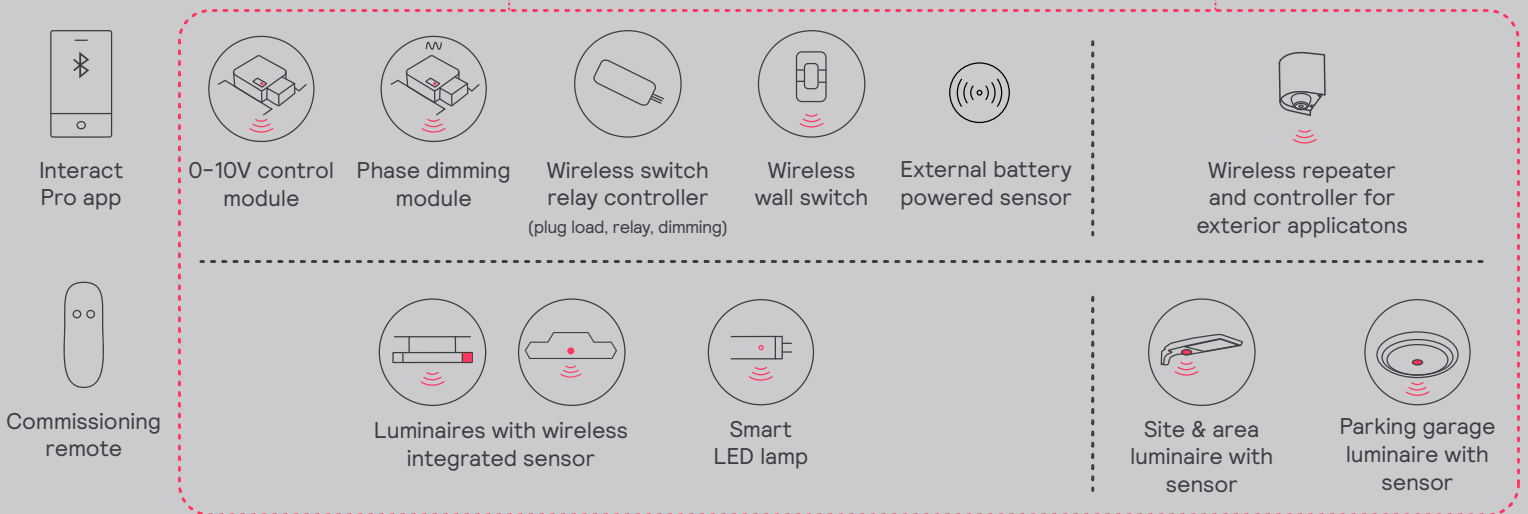

# Sequence of operations

## Lighting

- Interact ready luminaires or retrofit kits with integrated wireless occupancy & daylight sensors.
- UL924 emergency control capabilities via luminaire integrated battery backup or via UL924 emergency shunt relay.
  - Upon emergency, UL924 shunt relay bypasses the sensor and forces the lights to 100% level.
  - Option to select ER100 or GTD UL924 approved devices on the luminaire spec sheet.
- System bridge accessory with integrated wireless occupancy & daylight sensors and wired to the 0-10V downlight circuits.
- 20 Amp Interact RF switch relay wired to each 0-10V circuit for integration with generic 0-10V fixtures.
- 20 Amp Interact RF switch relay wired to dedicated receptacles.

## Logical grouping & zoning

- Use IR remote and Interact Pro App for configuration
  - Up to 200 wireless devices per network
  - Up to 64 groups and zones
  - Up to 40 lights & 5 ZigBee Green Power (ZGP) devices per group
  - Up to 16 scenes per group
- All lights, switches, sensors and plug load controller grouped together.
- A dedicated daylight zone for lights near the window.
- A dedicated zone for white board fixture or projector
- A dedicated zone for general area

## High end trim

- Range 0% to 100%, out of the box, set to 100%.
- Option to select alternate value via the App.

## Occupancy modes & Switch on/off behaviors

- Option to change switch on/off behaviors in the configuration App.
- Option to select one of 5 Area based configurations where all lights in the group have the same light level irrespective of occupancy pattern within that group.
  - Area Manual on Manual off (default)
  - Area Manual on Auto Off
  - Area Manual On Auto Off with Daylight Dependent Regulation (DDR) : DDR per luminaire in the zone(s) for sensor-based luminaires
  - Area Auto on Auto Off
  - Area Auto on Auto Off with Daylight Dependent Regulation (DDR): DDR per luminaire in the zone(s) for sensor-based luminaires
- Option to select Individual light-based behaviors for adaptive dimming feature where light levels adapt to occupancy pattern within that group.
  - Light Auto On Auto Off : adaptive dimming without daylight regulation
  - Light Auto On Auto Off with DDR : adaptive dimming with daylight regulation

- Option to set vacancy level to any value between 0% to 100%.
- Configurable sensor timeouts
  - Hold time (T3\* to T4\*) configurable from 5 min to 60 min
  - Prolong time (T5\* to T6\*) configurable from 0 min to 30 min

## Daylight Regulation

- Must create a dedicate daylight zone to activate daylight regulation. Daylight calibration required.
- Option to disable daylight regulation by selecting a non-DDR switch on/off behavior in the configuration App
- Individual luminaire performing daylight dimming in the zone.
- Continuous dimming to OFF via the daylight sensor.

## Manual Controls

- 4 button switch
  - Button 1 set to ON & ramp up
  - Button 2 & 3 set as programmable scenes
  - Button 4 set as OFF & ramp down
- 2 button switch
  - Button 1 set to ON & ramp up
  - Button 2 set to OFF & ramp down

## Scheduling (requires a gateway)

- Set specific action (ON / OFF or Scene recall) per lighting group based on specific day and time inputs.
- Schedules can be created and managed by using both the app and the portal.

## Load shedding / Demand Response (requires a gateway)

- Requires installation and configuration of an EISS box (EISS Box Set Up - IPKeys Technologies)
- Configure load reduction level and active time using the Interact Pro portal

## Optional additional features:

### Advanced:

- Energy monitoring, reporting & lighting asset performance information and time-based schedule available through LCN1840.
- Automatic demand response available through LCN1870 and EISS box.

### Enterprise:

- BACnet integration, energy monitoring, reporting & lighting asset performance information and time-based schedule available through LCN1850 + LCN1860.
- Access to Space Management and Productivity IoT Applications and rich data sets through SC1500 sensor bundle

\* See System Behavior diagram on page 4 for details

# Sensor installation guidance

Easily enhance your smart lighting system with the stand-alone wireless multi sensor or integrated multi sensor, which are Interact Ready. They trigger automatic responses to turn on, off or dim the lights according to occupancy detection and daylight variation. The result? Greater energy saving, more control possibilities and a more adaptable space!

## Motion detection area

### With stand-alone wireless multi sensor

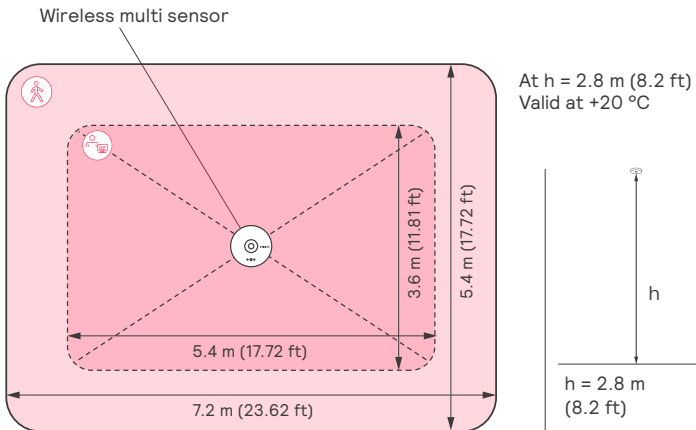

### With multi sensor integrated in luminaire

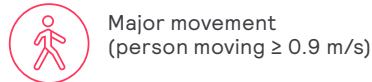
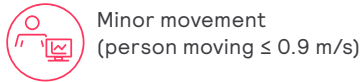
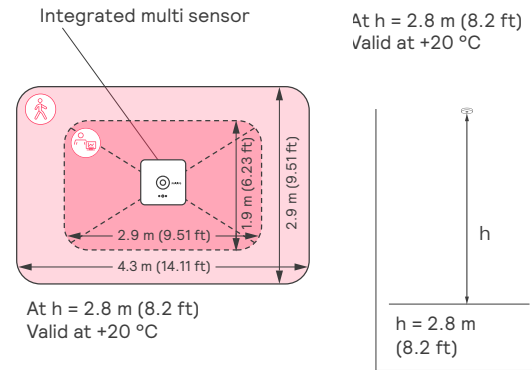

## Daylight detection area

### With stand-alone wireless multi sensor

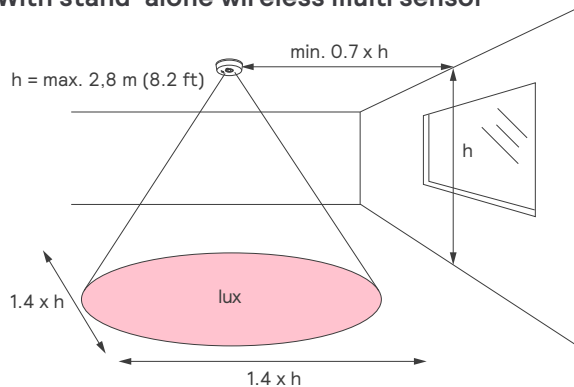

### With multi sensor integrated in luminaire

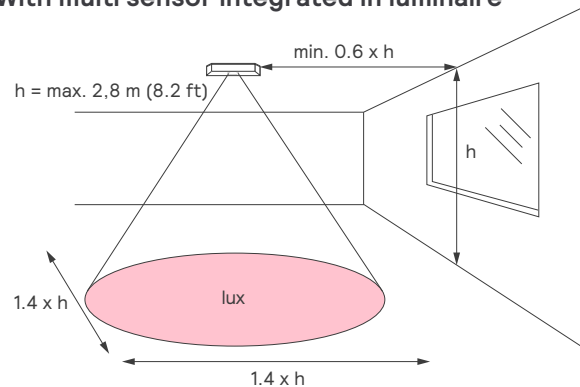



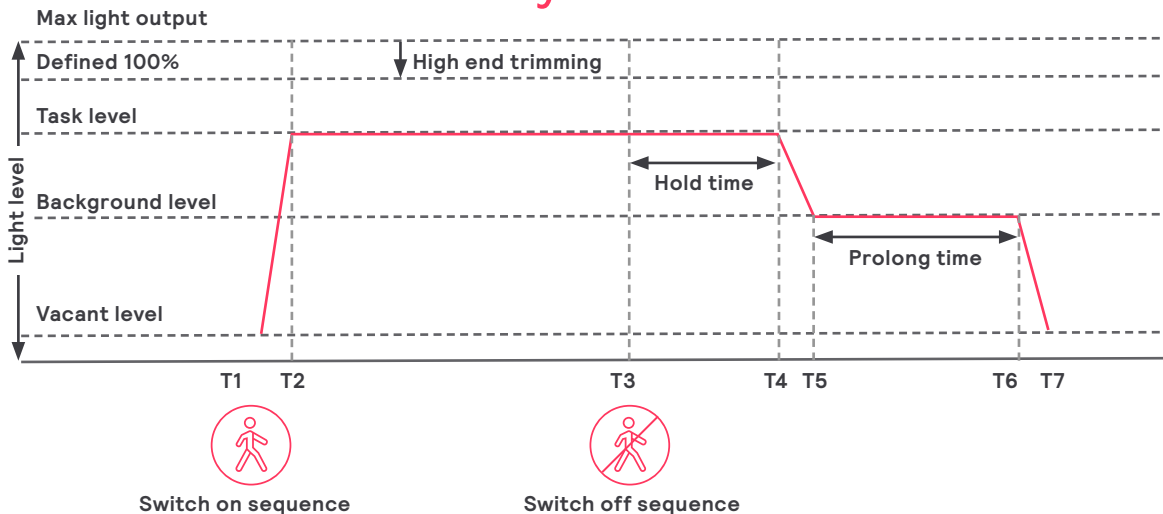



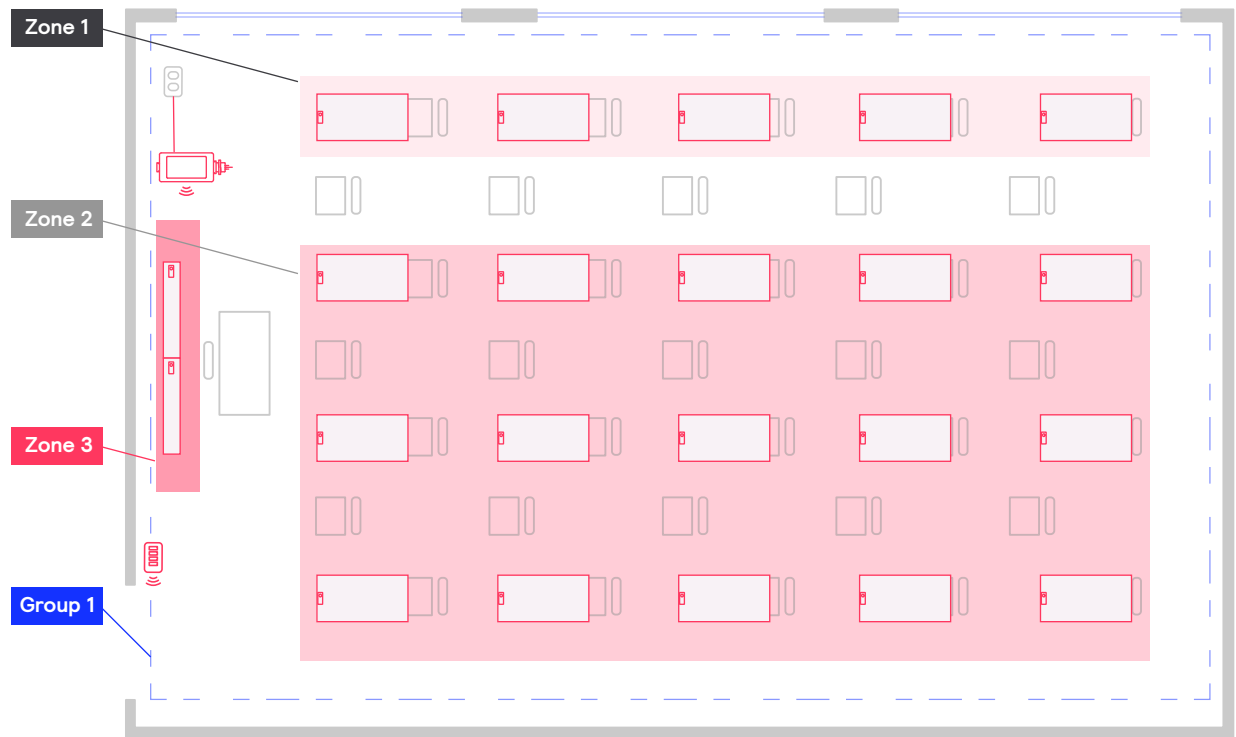

## System behavior



# Classroom with luminaire integrated sensors









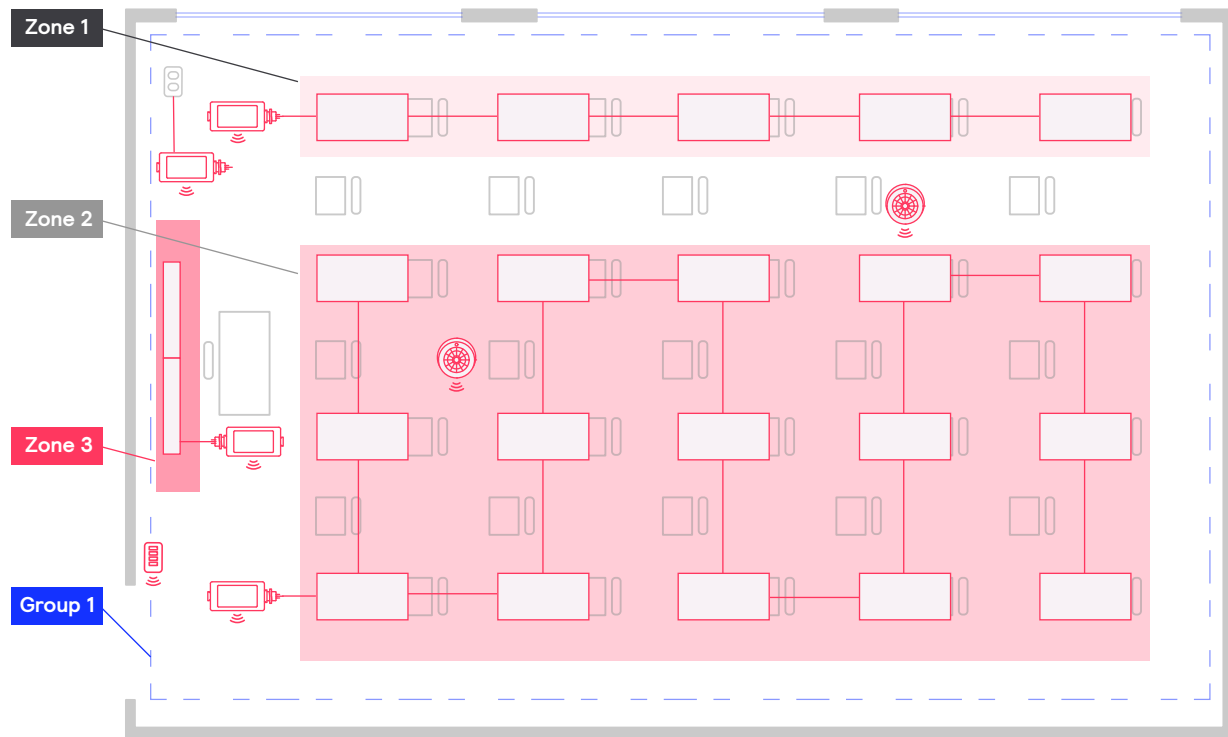



## Bill of materials

Example photo	Key image	Description	Catalog number	Qty	ASHRAE 2019	T24 2022	IECC 2021
		Interact ready 2x4 troffers with wireless occupancy and daylight sensor	Various	20			
		Interact ready linear luminaires with wireless occupancy and daylight sensor	Various	2	9.4.1.1(a) 9.4.1.1(b) 9.4.1.1(c) 9.4.1.1(d) 9.4.1.1(e) 9.4.1.1(h)	130.1(a) 130.1(b) 130.1(c) 130.1(d)	C405.2.1 C405.2.2 C405.2.3
		Wireless switch (ZGP switch dim 4 button)	SWS200 or UID8465	1			
		Interact Ready RF switch relay	RFSR10	1	8.4.2	130.5(d)	
		Interact commissioning remote + Interact Pro App	IRT9015 and download the iOS or Android App	1			

# Classroom with external wireless sensors









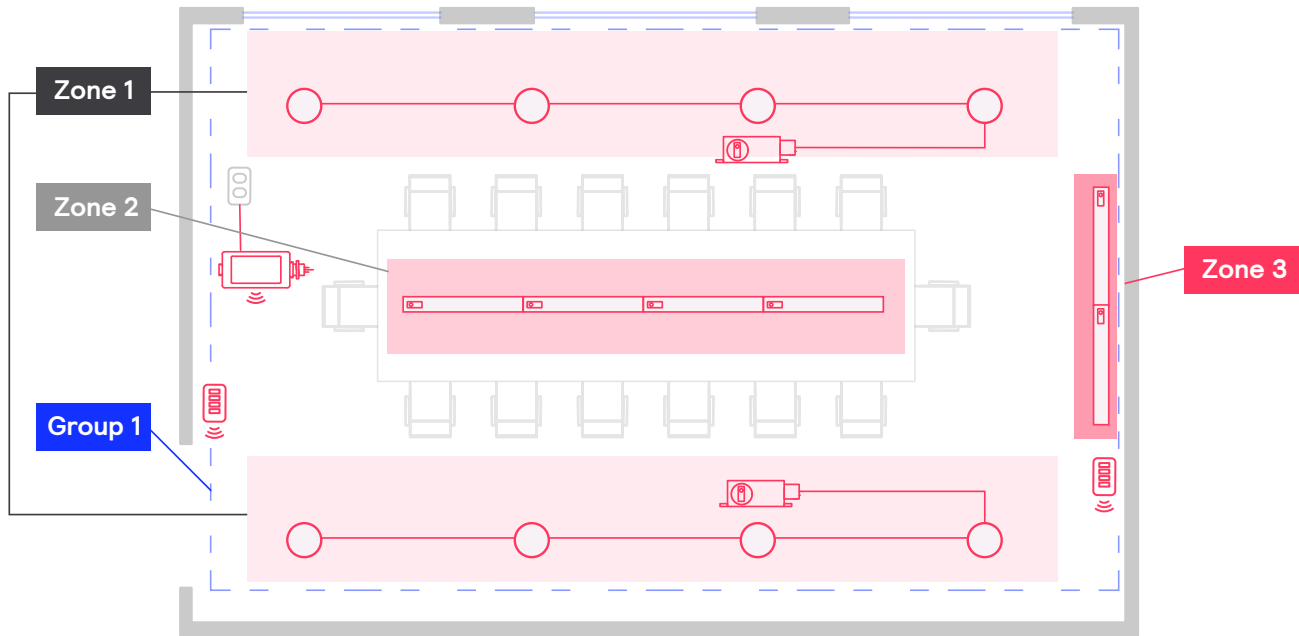

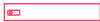

## Bill of materials

Example photo	Key image	Description	Catalog number	Qty	ASHRAE 2019	T24 2022	IECC 2021
		2x4 0-10V troffers	Various	20			
		0-10V linear luminaires	Various	2	9.4.1.1(a) 9.4.1.1(b) 9.4.1.1(c) 9.4.1.1(d) 9.4.1.1(e) 9.4.1.1(h)	130.1(a) 130.1(b) 130.1(c) 130.1(d)	C405.2.1 C405.2.2 C405.2.3
		Wireless switch (ZGP switch dim 4 button)	SWS200 or UID8465	1			
		Wireless IP65 occupancy and daylight sensor	LCN3120/05	2			
		Interact Ready RF switch relay	RFSR10	4	8.4.2	130.5(d)	
		Interact commissioning remote + Interact Pro App	IRT9015 and download the iOS or Android App	1			

# Meeting room with downlights and linear luminaires with integrated sensors



## Bill of materials







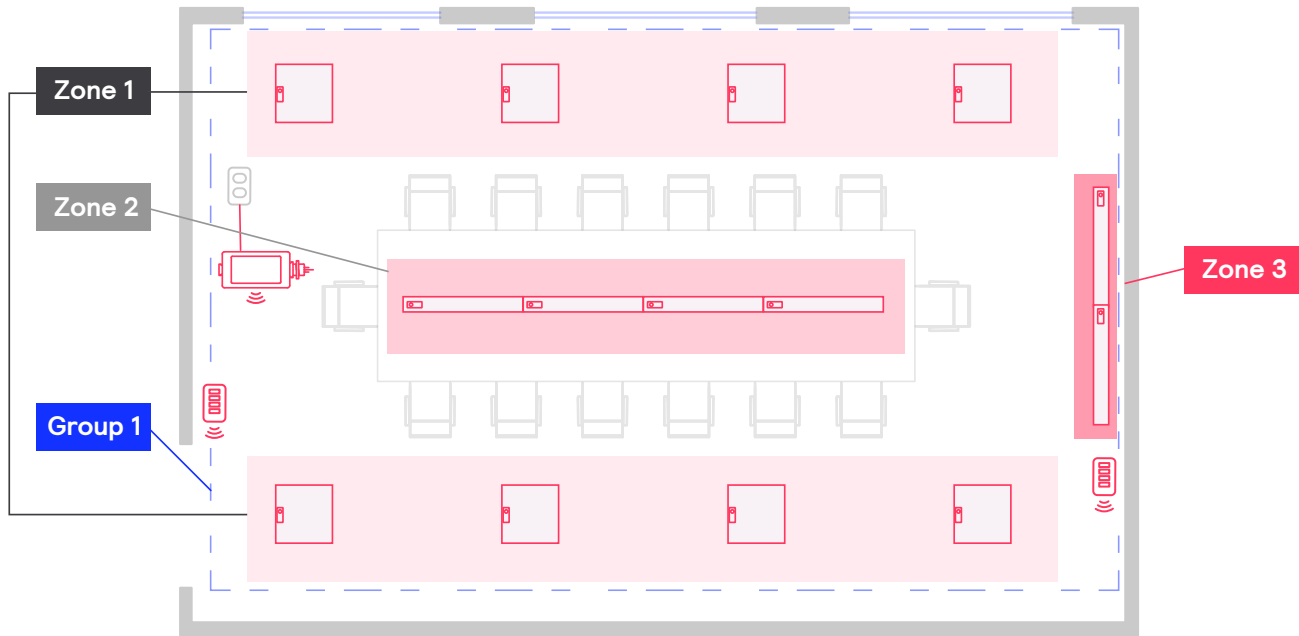

Example photo	Key image	Description	Catalog number	Qty	ASHRAE 2019	T24 2022	IECC 2021
		0-10V downlights	Various	8			
		Interact ready linear luminaires with wireless occupancy and daylight sensor	Various	6	9.4.1.1(a) 9.4.1.1(b) 9.4.1.1(c) 9.4.1.1(d) 9.4.1.1(e) 9.4.1.1(h)	130.1(a) 130.1(b) 130.1(c) 130.1(d)	C405.2.1 C405.2.2 C405.2.3
		Wireless switch (ZGP switch dim 4 button)	SWS200 or UID8465	2			
		System bridge accessory 0-10V with wireless occupancy and daylight sensor	SBAZ10-CS	2			
		Interact Ready RF switch relay	RFSR10	1	8.4.2	130.5(d)	
		Interact commissioning remote + Interact Pro App	IRT9015 and download the iOS or Android App	1			



# Meeting room with troffers and linear luminaires with integrated sensors



## Bill of materials

Example photo	Key image	Description	Catalog number	Qty	ASHRAE 2019	T24 2022	IECC 2021
		Interact ready 2x2 troffers with wireless occupancy and daylight sensor	Various	8			
		Interact ready linear luminaires with wireless occupancy and daylight sensor	Various	6	9.4.1.1(a) 9.4.1.1(b) 9.4.1.1(c) 9.4.1.1(d) 9.4.1.1(e) 9.4.1.1(h)	130.1(a) 130.1(b) 130.1(c) 130.1(d)	C405.2.1 C405.2.2 C405.2.3
		Wireless switch (ZGP switch dim 4 button)	SWS200 or UID8465	2			
		Interact Ready RF switch relay	RFSR10	1	8.4.2	130.5(d)	
		Interact commissioning remote + Interact Pro App	IRT9015 and download the iOS or Android App	1			



# Private office with troffers with integrated sensors

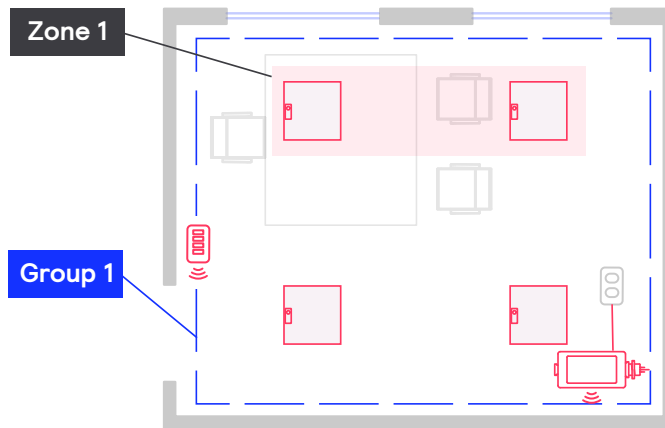

## Bill of materials

Example photo	Key image	Description	Catalog number	Qty	ASHRAE 2019	T24 2022	IECC 2021
		Interact ready 2x2 troffers with wireless occupancy and daylight sensor	Various	4	9.4.1.1(a) 9.4.1.1(b) 9.4.1.1(c) 9.4.1.1(d) 9.4.1.1(e) 9.4.1.1(h)	130.1(a) 130.1(b) 130.1(c) 130.1(d)	C405.2.1 C405.2.2 C405.2.3
		Wireless switch (ZGP switch dim 4 button)	SWS200 or UID8465	1			
		Interact Ready RF switch relay	RFSR10	1	8.4.2	130.5(d)	
		Interact commissioning remote + Interact Pro App	IRT9015 and download the iOS or Android App	1			

# Corridor with troffers and integrated sensors

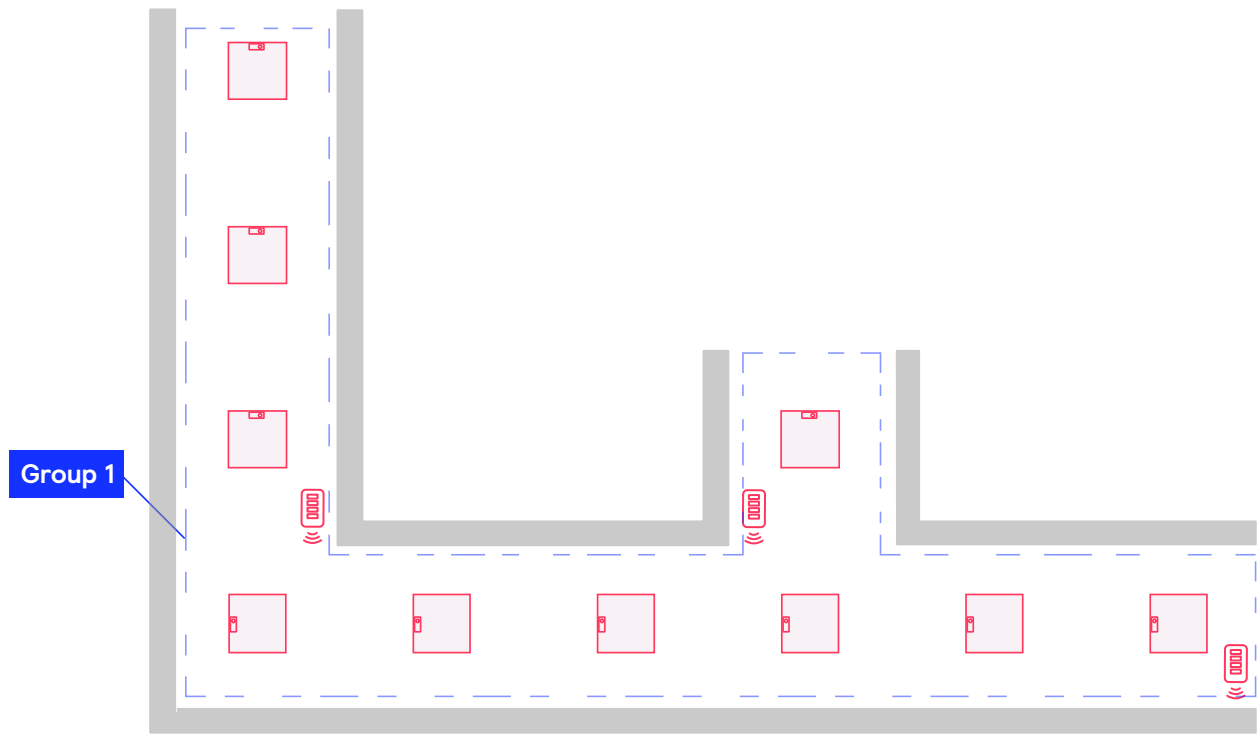

## Bill of materials

Example photo	Key image	Description	Catalog number	Qty	ASHRAE 2019	T24 2022	IECC 2021
		Interact ready 2x2 troffers with wireless occupancy and daylight sensor	Various	10	9.4.1.1(a) 9.4.1.1(b) 9.4.1.1(c) 9.4.1.1(d) 9.4.1.1(e) 9.4.1.1(h)	130.1(a) 130.1(b) 130.1(c) 130.1(d)	C405.2.1 C405.2.2 C405.2.3
		Wireless switch (ZGP switch dim 4 button)	SWS200 or UID8465	3			
		Interact commissioning remote + Interact Pro App	IRT9015 and download the iOS or Android App	1			

# Corridor with downlights and System bridge accessories

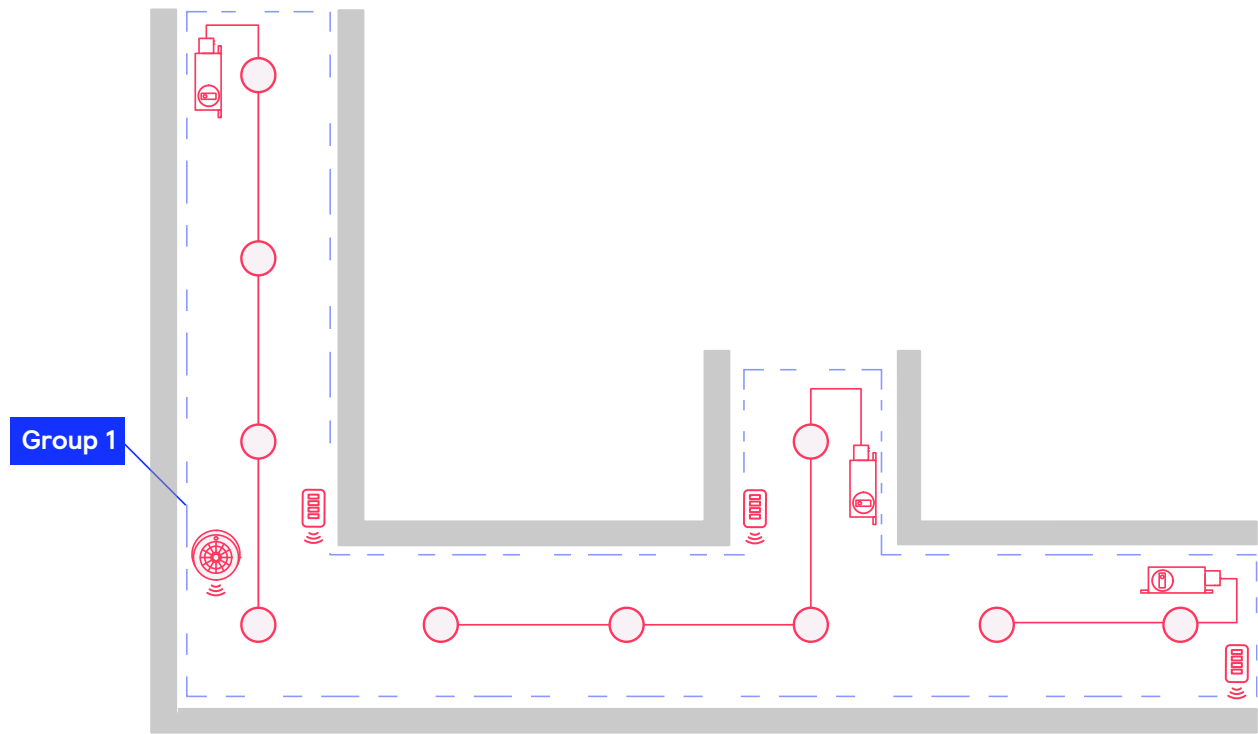







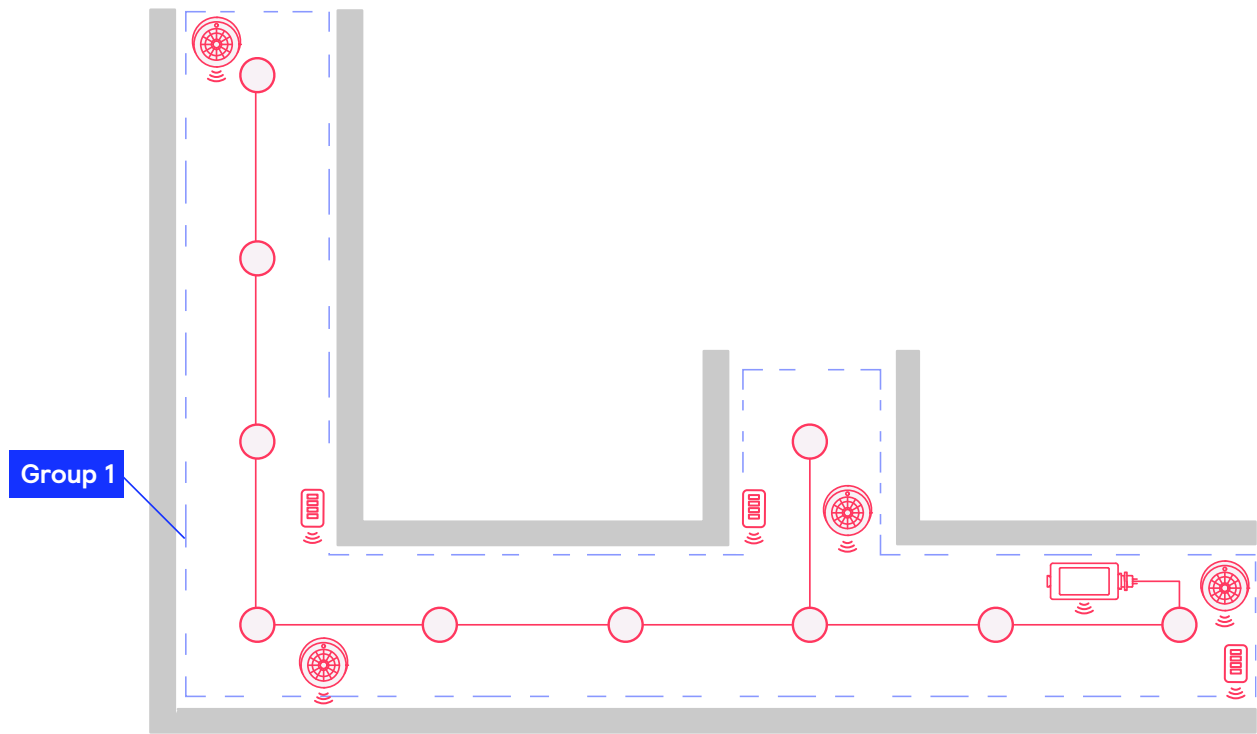

## Bill of materials

Example photo	Key image	Description	Catalog number	Qty	ASHRAE 2019	T24 2022	IECC 2021
		0-10V downlights	Various	10			
		Wireless IP65 occupancy and daylight sensor	LCN3120/05	1	9.4.1.1(a) 9.4.1.1(b) 9.4.1.1(c) 9.4.1.1(d) 9.4.1.1(e) 9.4.1.1(h)	130.1(a) 130.1(b) 130.1(c) 130.1(d)	C405.2.1 C405.2.2 C405.2.3
		Wireless switch (ZGP switch dim 4 button)	SWS200 or UID8465	3			
		System bridge accessory 0-10V with wireless occupancy and daylight sensor	SBAZ10-CS	3			
		Interact commissioning remote + Interact Pro App	IRT9015 and download the iOS or Android App	1			

# Corridor with downlights and RF switch relay









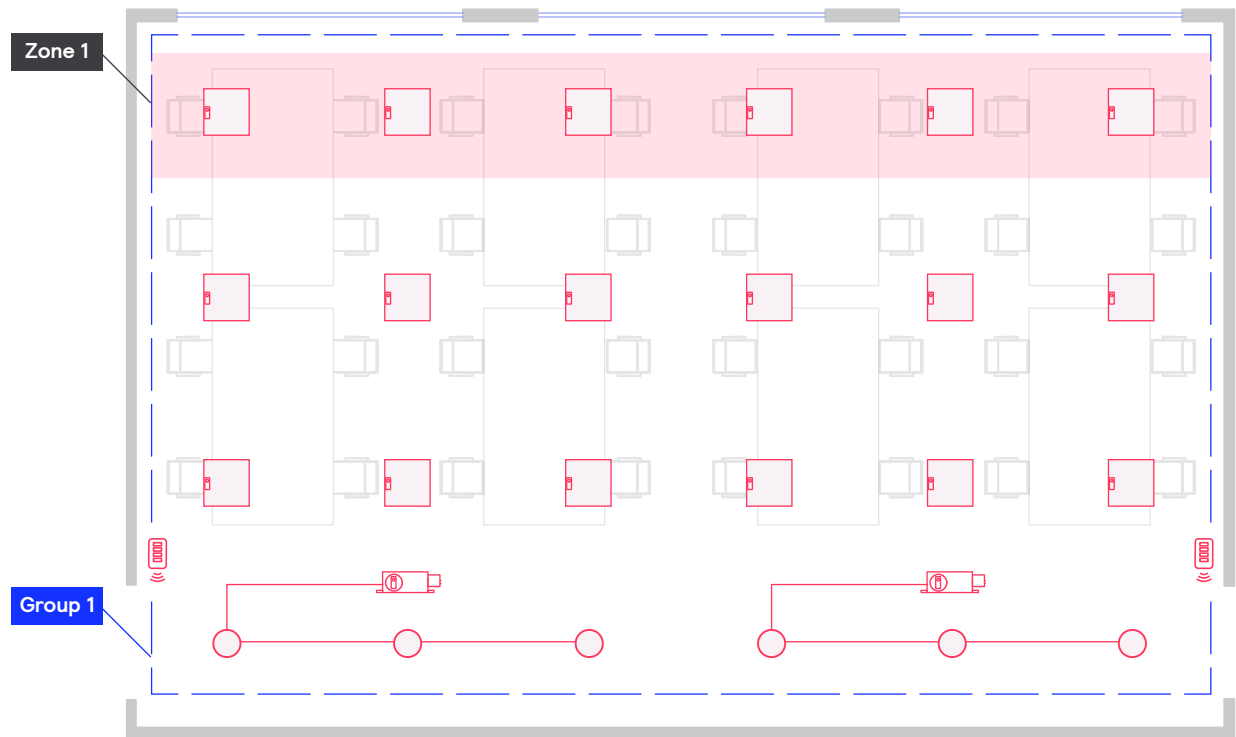

## Bill of materials

Example photo	Key image	Description	Catalog number	Qty	ASHRAE 2019	T24 2022	IECC 2021
		0-10V downlights	Various	10			
		Wireless IP65 occupancy and daylight sensor	LCN3120/05	4	9.4.1.1(a) 9.4.1.1(b) 9.4.1.1(c) 9.4.1.1(d) 9.4.1.1(e) 9.4.1.1(h)	130.1(a) 130.1(b) 130.1(c) 130.1(d)	C405.2.1 C405.2.2 C405.2.3
		Wireless switch (ZGP switch dim 4 button)	SWS200 or UID8465	3			
		Interact Ready RF switch relay	RFSR10	1	8.4.2	130.5(d)	
		Interact commissioning remote + Interact Pro App	IRT9015 and download the iOS or Android App	1			

# Open office with troffers and luminaire integrated sensors

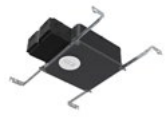

## Bill of materials

Example photo	Key image	Description	Catalog number	Qty	ASHRAE 2019	T24 2022	IECC 2021
		Interact ready 2x2 troffers with wireless occupancy and daylight sensor	Various	18			
		0-10V downlights	Various	6	9.4.1.1(a) 9.4.1.1(b) 9.4.1.1(c) 9.4.1.1(d) 9.4.1.1(e) 9.4.1.1(h)	130.1(a) 130.1(b) 130.1(c) 130.1(d)	C405.2.1 C405.2.2 C405.2.3
		Wireless switch (ZGP switch dim 4 button)	SWS200 or UID8465	2			
		System bridge accessory 0-10V with wireless occupancy and daylight sensor	SBAZ10-CS	2			
		Interact commissioning remote + Interact Pro App	IRT9015 and download the iOS or Android App	1			

# Open office with linear luminaires and troffers with integrated sensors

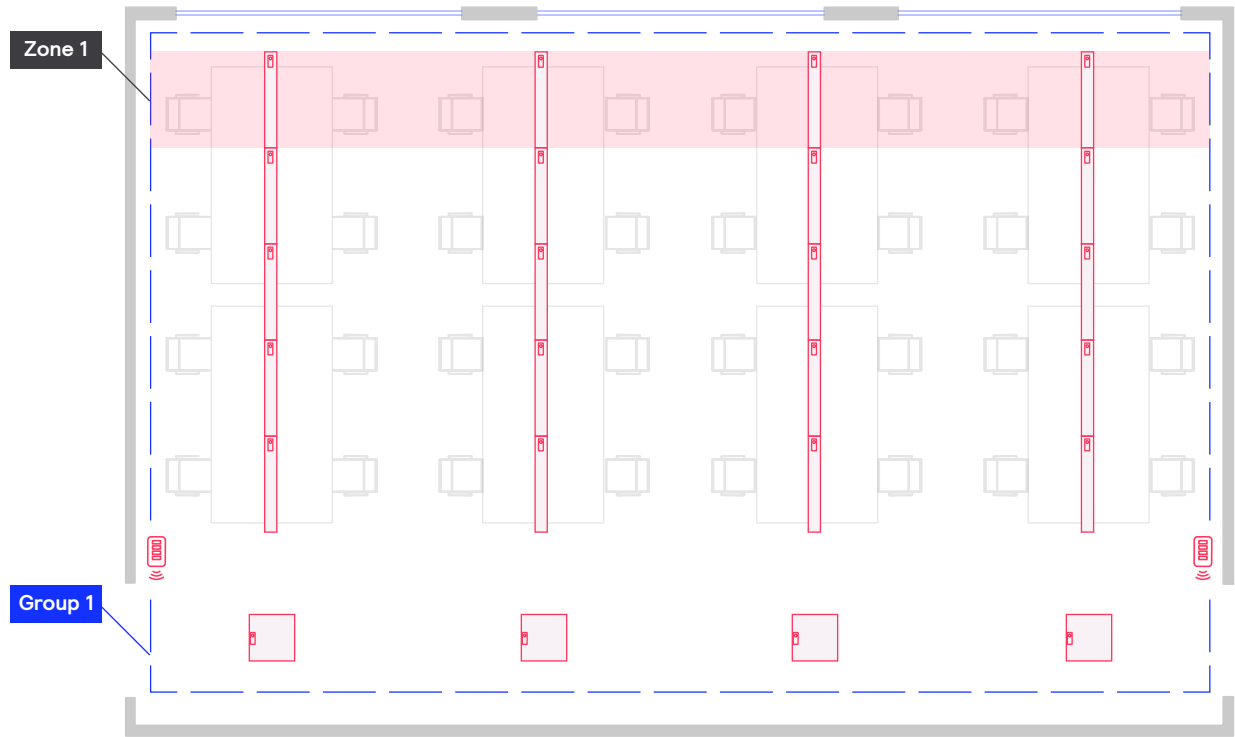



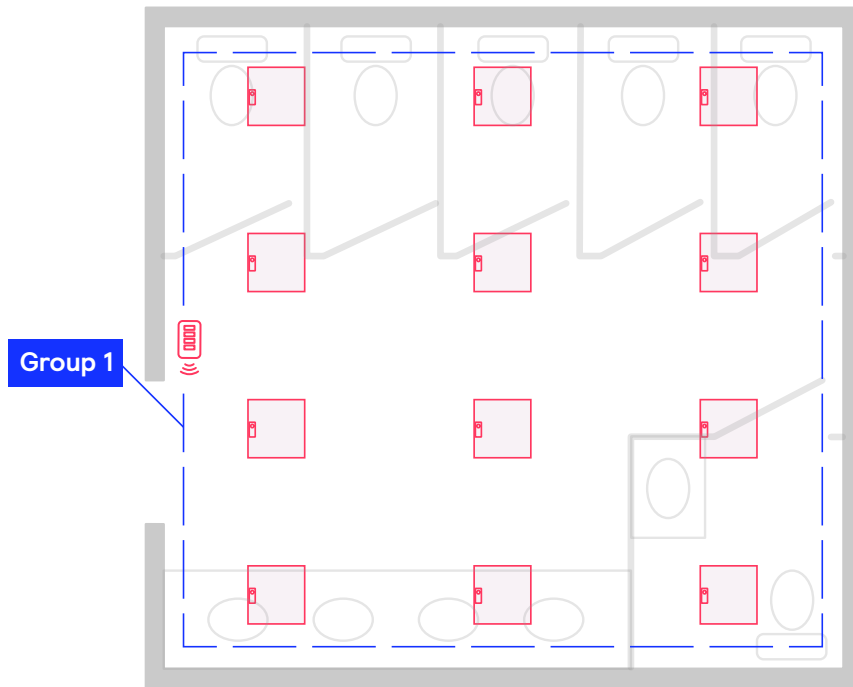

## Bill of materials

Example photo	Key image	Description	Catalog number	Qty	ASHRAE 2019	T24 2022	IECC 2021
		Interact ready 2x2 troffers with wireless occupancy and daylight sensor	Various	4			
		Interact ready linear luminaires with wireless occupancy and daylight sensor	Various	20	9.4.1.1(a) 9.4.1.1(b) 9.4.1.1(c) 9.4.1.1(d) 9.4.1.1(e) 9.4.1.1(h)	130.1(a) 130.1(b) 130.1(c) 130.1(d)	C405.2.1 C405.2.2 C405.2.3
		Wireless switch (ZGP switch dim 4 button)	SWS200 or UID8465	2			
		Interact commissioning remote + Interact Pro App	IRT9015 and download the iOS or Android App	1			

# Restroom with troffers with integrated sensors



## Bill of materials







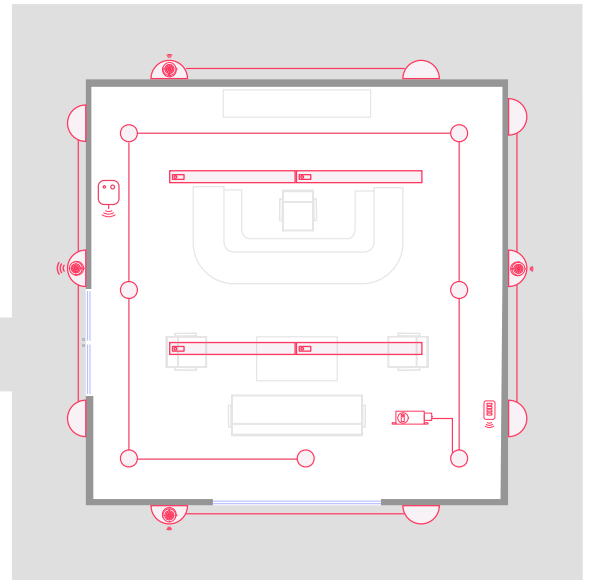
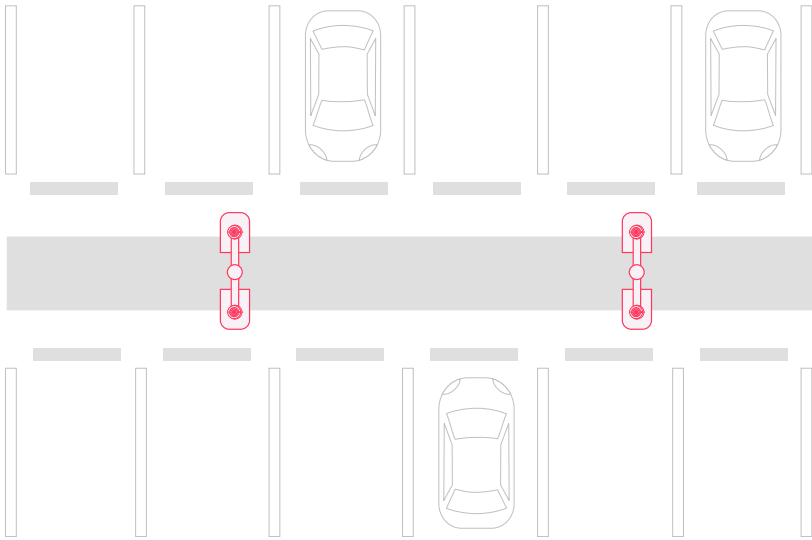









Example photo	Key image	Description	Catalog number	Qty	ASHRAE 2019	T24 2022	IECC 2021
		Interact ready 2x2 troffers with wireless occupancy and daylight sensor	Various	10	9.4.1.1(a) 9.4.1.1(b) 9.4.1.1(c) 9.4.1.1(d) 9.4.1.1(e) 9.4.1.1(h)	130.1(a) 130.1(b) 130.1(c) 130.1(d)	C405.2.1 C405.2.2 C405.2.3
		Wireless switch (ZGP switch dim 4 button)	SWS200 or UID8465	1			
		Interact commissioning remote + Interact Pro App	IRT9015 and download the iOS or Android App	1			



# Parking lot with poles integrated with indoor fixtures









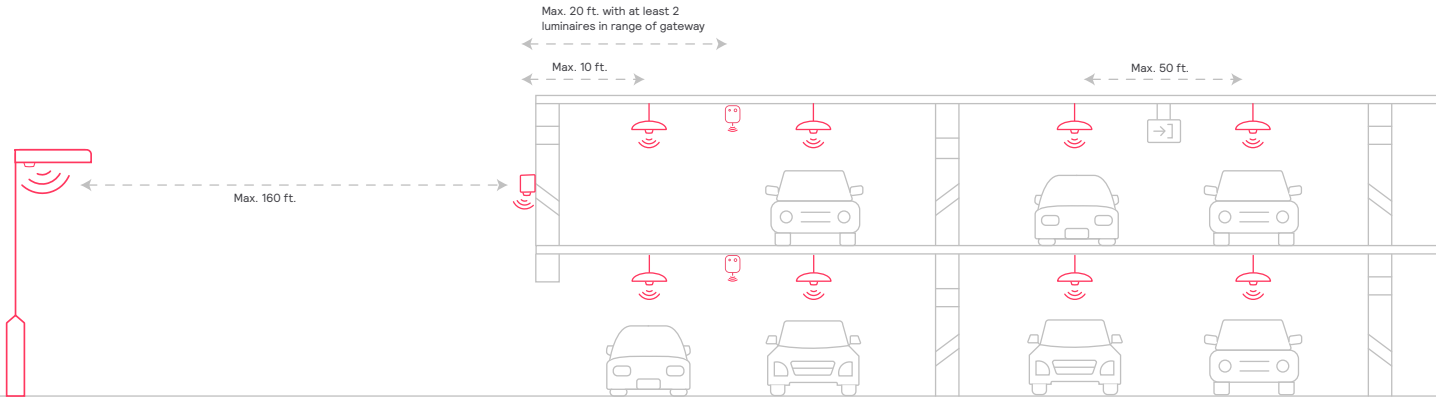

## Bill of materials

Example photo	Key image	Description	Catalog number	Qty	ASHRAE 2019	T24 2022	IECC 2021
		Interact ready Gardco fixtures with wireless occupancy and daylight sensor	Various	4	9.4.1.1(a) 9.4.1.1(b) 9.4.1.1(c) 9.4.1.1(d) 9.4.1.1(e) 9.4.1.1(h) 9.4.1.1(i) 9.4.1.2	130.1(a) 130.1(b) 130.1(c) 130.1(d) 130.2(c)	C405.2.1 C405.2.2 C405.2.3 C405.2.7
		Interact ready linear luminaires with wireless occupancy and daylight sensor	Various	4			
		Wireless switch (ZGP switch dim 4 button)	SWS200 or UID8465	1			
		System bridge accessory 0-10V with wireless occupancy and daylight sensor	SBAZ10-CS	1			
		0-10V downlights	Various	7			
		Interact ready Gardco Geoform repeater		3			
		0-10V exterior sconce fixture	Various	6			
		Interact Gateway	LCN1840	1			
		Interact commissioning remote + Interact Pro App	IRT9015 and download the iOS or Android App	1			

# Parking garage with LED fixtures with integrated sensors



## Bill of materials

Example photo	Key image	Description	Catalog number	Qty	ASHRAE 2019	T24 2022	IECC 2021
		Interact ready Gardco fixtures with wireless occupancy and daylight sensor	Various	1	9.4.1.1(i) 9.4.1.2	130.1(b) 130.1(c) 130.1(d) 130.2(c)	C405.2.7 C405.2.8
		Interact ready Gardco fixtures with wireless occupancy and daylight sensor	Various	6			
		Interact ready Gardco Geoform repeater		1			
		Interact Gateway	LCN1840	1			
		Interact commissioning remote + Interact Pro App	IRT9015 and download the iOS or Android App	1			

© 2021 Signify Holding. All rights reserved. The information provided herein is subject to change, without notice. Signify does not give any representation or warranty as to the accuracy or completeness of the information included herein and shall not be liable for any action in reliance thereon. The information presented in this document is not intended as any commercial offer and does not form part of any quotation or contract, unless otherwise agreed by Signify. All trademarks are owned by Signify Holding or their respective owners.