



by @signify



Architectural
Linear

TruGroove

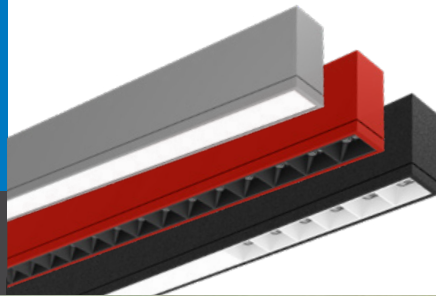

The entire family,
all under one roof

TruGroove shapes



TruGroove wall and suspended



TruGroove suspended micro



TruGroove surface



TruGroove recessed



TruGroove recessed micro



TruGroove perimeter



TruGroove cove



Welcome to TruGroove, a world of endless possibilities

- 1 TruGroove suspended cross (3")
- 2 TruGroove suspended square & rectangle (3")
- 3 TruGroove suspended indirect (3")
- 4 TruGroove suspended indirect/direct (3")
(also available in direct/indirect & direct)
- 5 TruGroove suspended micro indirect (1.75")
- 6 TruGroove suspended micro indirect/direct (1.75")
(also available in direct/indirect & direct)
- 7 TruGroove wall micro indirect/direct (1.75")
(also available in direct/indirect)
- 8 TruGroove wall micro direct (1.75")
- 9 TruGroove wall direct/indirect (3")
(also available in direct/indirect)
- 10 TruGroove wall direct (3")
(also available in indirect)
- 11 TruGroove recessed ceiling & wall (3")
- 12 TruGroove recessed micro ceiling (1.75")
- 13 TruGroove perimeter ambient
- 14 TruGroove perimeter graze
- 15 TruGroove surface (3")
- 16 TruGroove surface micro (1.75")
- 17 TruGroove cove





2

11

12

16

15

6

13

14

17

Refined design for distinctive spaces



Including some you've
yet to imagine...

Copper louver



Louver/lens combo



Black lens



Wall to ceiling transition



Custom angles

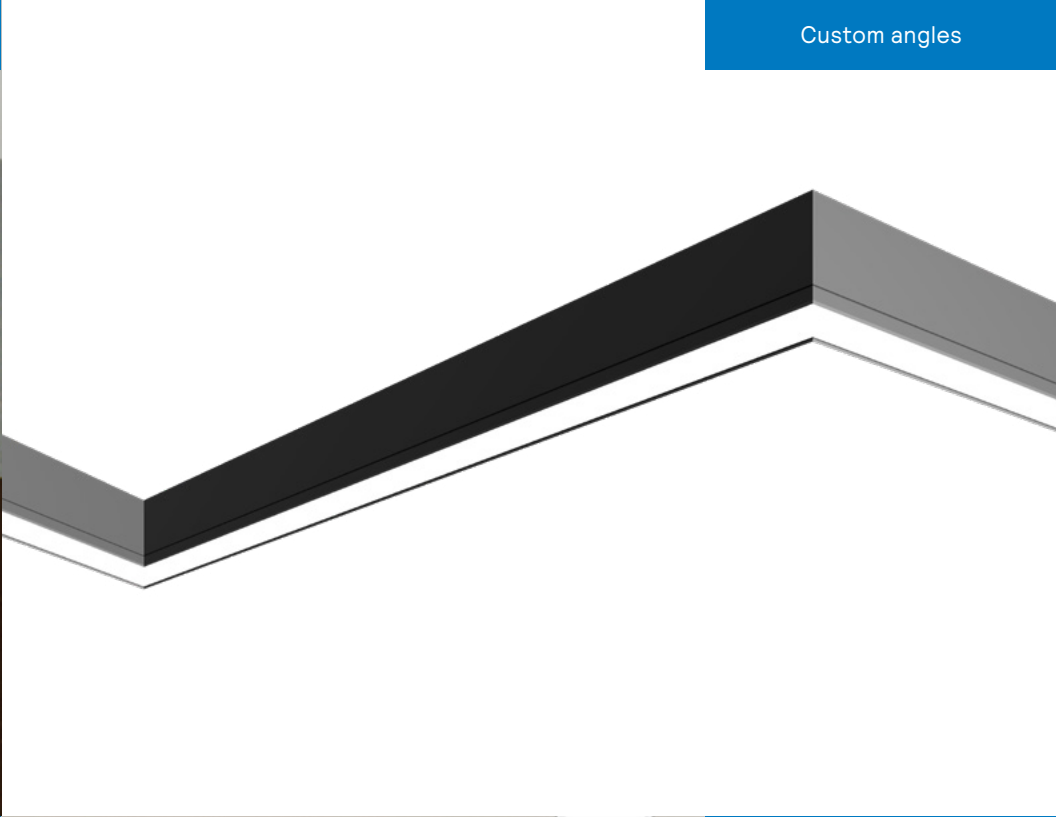

Drop lens



Recessed lens/louver combo





TruGroove is an aesthetically cohesive family with total application flexibility and superior illumination

Stylish continuity with versatility

- Enjoy the same sophisticated style from each product without sacrificing performance.
- Take advantage of numerous optical distributions.
- Create custom angles, patterns, and unique color combinations.
- Reap the benefits of MesoOptics technology, AccuRender CRI 90, and Interact Pro sensors.
- The family is designed around unique MesoOptics technology for minimal glare and superior lighting control.
- AccuRender CRI 90 is standard, ensuring excellent color rendering, TM30 color appearance preference ratings, and boasting 15-20% better efficacy than leading competitor's CRI 90 products at comparable lumen packages.
- Easily incorporate Interact Pro scalable sensors for convenience and energy efficiency.



True Lighting Application Efficacy – the sum is greater than its parts

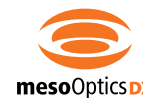

interact

Similarly to how a single metric does not adequately reveal the complexity of the visual perception of color, light source efficiency measured strictly as lumens/watt does not effectively describe the efficiency performance of a luminaire.

Ledalite's signature technology innovations combine to ensure that you have the right light in the right place at the right time to meet your design requirements and application needs without compromise.

See pages 32-37 for more details on all three of these features.

Light source efficiency – lumens per watt	✓	✓
Optical efficacy – precisely crafted control of the beam		✓
Spectral efficacy – provide lighting tailored for well being, visual acuity, and color quality	✓	
Control effectiveness – ensure that lights are on when needed and off when not needed		✓



TruGroove shapes 3"

new

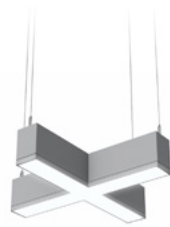

2'x2' Cross



1'x1' Square

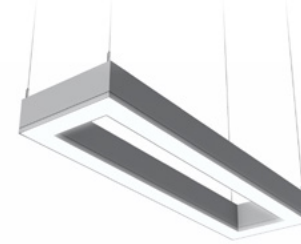

1'x4' Rectangle

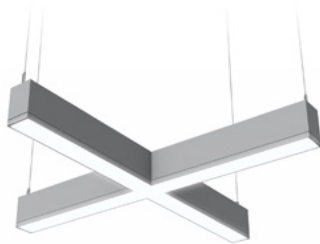

4'x4' Cross



2'x2' Square



2'x4' Rectangle

Complementary shapes – perfect match to any design looking to make a statement with uniformity consistency and quality



TruGroove suspended micro 1.75"

new

Suspended indirect/direct

Model: TM05L935NQCFF15Q20

Lumen Package*	1500lm down / 2000lm up
Efficacy	106 LPW
Average Light Level	33.7 fc
Max/Min Workplane**	2.65
Energy Density	0.21 W/ft ²

Room: 16'L x 20'W x 9'H
Based on AccuRender CRI 90, 3500K color temperature
*Nominal value /4ft luminaire. **Excludes outer edges of space.

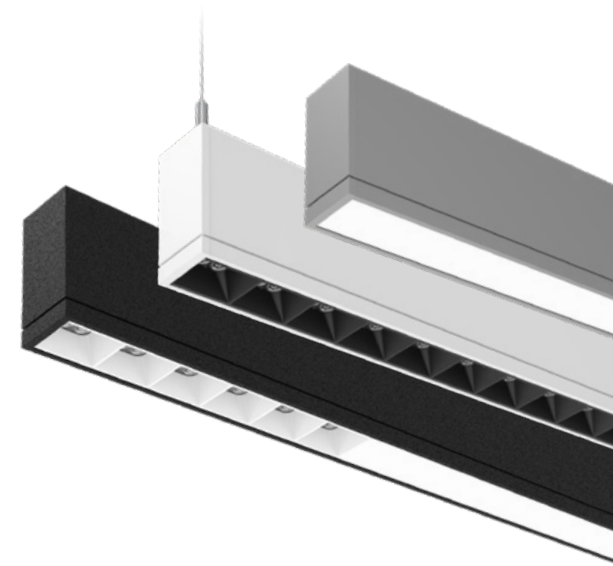

Innovative optics deliver exceptional uniformity and wide row spacing from a 1.75" aperture continuous line of light. Unique quad optic louver cells offer a wide range of options from graze to stack to asymmetric wall wash.



TruGroove suspended 3"

Suspended direct

Model: 29x1L93515QN

Lumen Package*	1500lm
Efficacy	98.2 LPW
Average Light Level	34.8 fc
Max/Min Workplane**	2.52
Energy Density	0.37 W/ft ²

Room: 40'Lx16'Wx9'H
Based on AccuRender CRI 90, 3500K color temperature
*Nominal value /4ft luminaire. **Excludes outer edges of space.

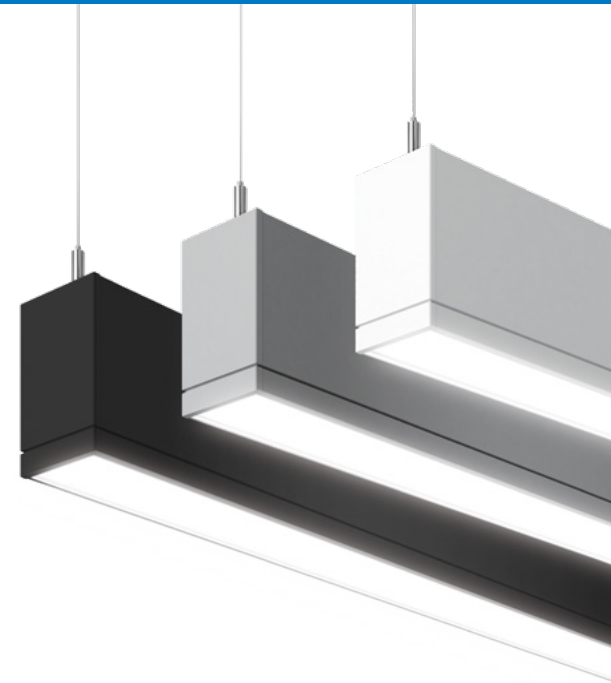

The MesoOptics DX technology in direct TruGroove suspended luminaires creates a visually comfortable environment while illuminated TruGroove corners provide design inspiration through geometric patterns.



TruGroove surface micro 1.75"

new

Surface mount micro direct

Model: TM0xL935QNNNN20NNN

Lumen Package*	2000lm
Efficacy	97 LPW
Average Light Level	18.9 fc (side corridor)
Max/Min Workplane**	1.55
Energy Density	0.48 W/ft ²

Room: 36' L x 6' W x 9' H
Based on AccuRender CRI 90, 3500K color temperature
*Nominal value /4ft luminaire. **Excludes outer edges of space.

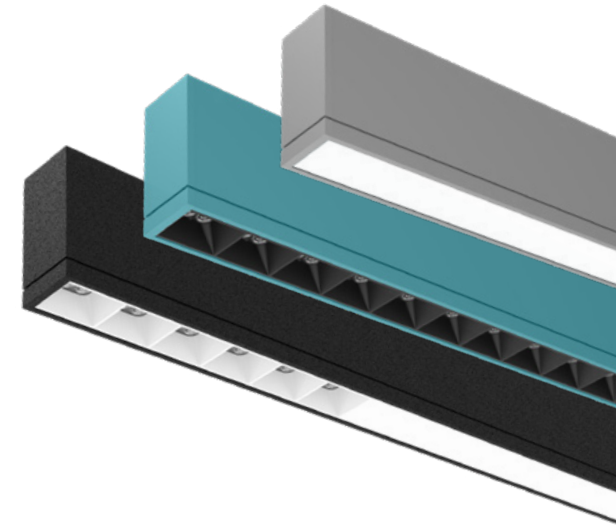

Small and mighty, TruGroove surface micro delivers more lighting distributions, superior color quality, and helps meet your energy savings targets.



TruGroove surface 3"

Surface mount direct

Model: 29x1L93522QN

Lumen Package*	2200lm
Efficacy	96.8 LPW
Average Light Level	47.2 fc
Max/Min Workplane**	1.9
Energy Density	0.55 W/ft ²

Room: 36' L x 18' W x 9' H
Based on AccuRender CRI 90, 3500K color temperature
*Nominal value /4ft luminaire. **Excludes outer edges of space.

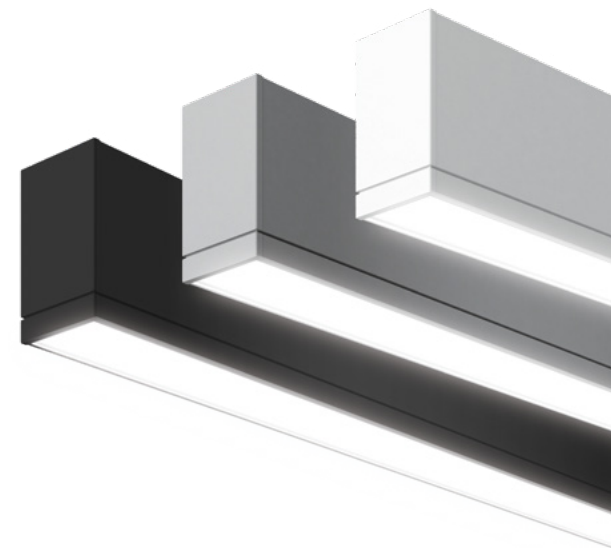

Drive your lighting performance beyond the edge with TruGroove surface. The engineered batwing distribution gives you exceptional control so you can create balanced, luminous spaces using fewer luminaires. MesoOptics DX technology delivers higher efficacies and reduced energy densities.



TruGroove wall micro 1.75"

new

Wall micro indirect/direct

Model: TM0xL935WNNNN15W30

Lumen Package*	1500lm down / 3000lm up
Efficacy	105.6 LPW
Average Light Level	23.8 fc (not considering daylight contribution)
Max/Min Workplane**	11.5
Energy Density	0.23 W/ft ²

Room: 30'L x 30'W x 8.5'H
Based on AccuRender CRI 90, 3500K color temperature
*Nominal value /4ft luminaire. **Excludes outer edges of space.

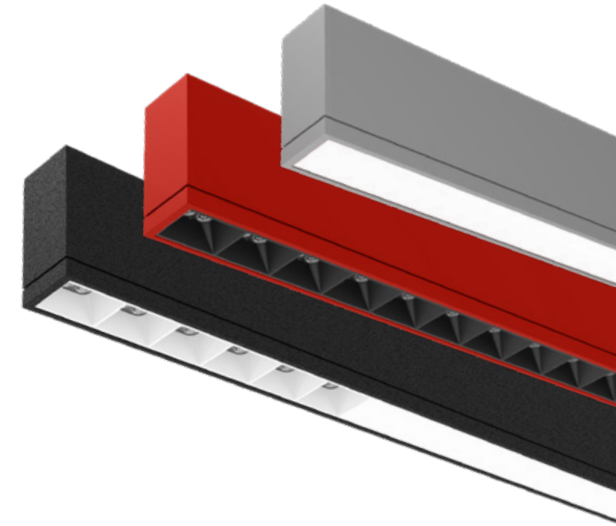

Declutter your ceiling without sacrificing performance.



TruGroove wall 3"

Wall indirect/direct

Model: 29x5L93552WW

Lumen Package*	5200lm (70% up, 30% down)
Efficacy	113.5 LPW
Average Light Level	21.2 fc (waiting area)
Max/Min Workplane**	5.3
Energy Density	0.28 W/ft ²

Room: 30'L x 30'W x 8.5'H
Based on AccuRender CRI 90, 3500K color temperature
*Nominal value /4ft luminaire. **Excludes outer edges of space.



Smooth, balanced light washes down the wall and illuminates the ceiling; creating a relaxing social environment from an asymmetric indirect/direct TruGroove wall luminaire with a dust cover.



TruGroove recessed micro 1.75"

Recessed micro direct

Model: 2301L93522Q

Lumen Package*	2200lm
Efficacy	91 LPW
Average Light Level	25.8 fc (floor) 32.5 fc (workplane)
Max/Min Workplane**	1.6 (floor) 2.1 (workplane)
Energy Density	0.42 W/ft ²

Room: 80'L x 25'W x 9'H (hallway), 11'H (main space)
Based on AccuRender CRI 90, 3500K color temperature
*Nominal value /4 ft luminaire. **Excludes outer edges of space.

1.75"
aperture



TruGroove recessed micro delivers the perfect combination of slender aesthetic and lighting control, creating luminous environments with smooth gradients of light.



TruGroove recessed 3"

Recessed direct

Model: 3901L93515Q (corridor)
3900L93515L (reception)

Lumen Package*	1500lm
Efficacy	104 LPW
Average Light Level	35.4 fc (corridor) 19.3 fc (reception work surface)
Max/Min Workplane**	6.14 (corridor) 1.7 (reception work surface)
Energy Density	0.43 W/ft ²

Room: 60'L x 54'W x 9'H
Based on AccuRender CRI 90, 3500K color temperature
*Nominal value /4 ft luminaire. **Excludes outer edges of space.

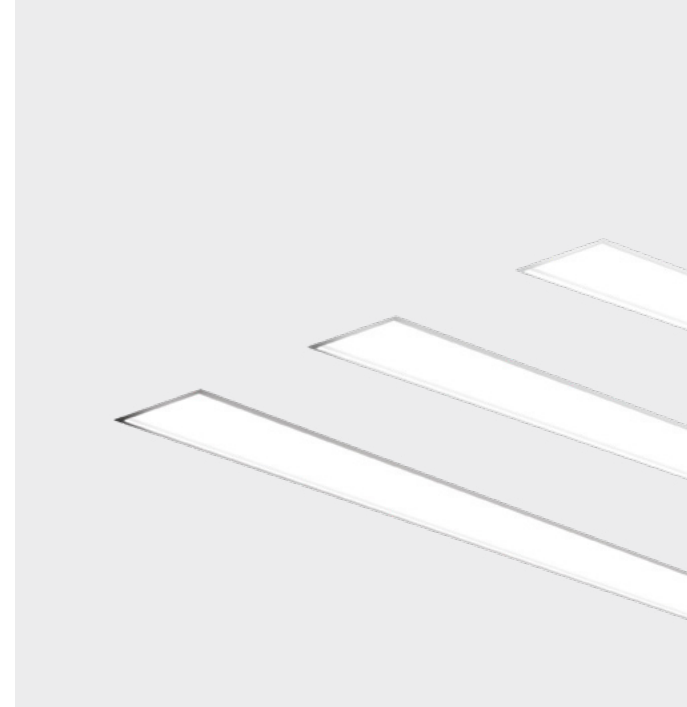

Space-defining TruGroove recessed with corners helps create a modern functional illuminated design full of movement and sustainable elegance.



TruGroove perimeter

Perimeter ambient

Model: 4908L94015Q

Lumen Package*	1500lm/4ft
Power & Color Temp	13.7 W/4ft, AccuRender CRI 90, 4000K
Efficacy	113.4 LPW
Light Level Workplane**	49.9 fc
Light Level Floor**	44.2 fc
Max/Min Workplane**	1.8
Max/Min Floor**	1.8
Energy Density	0.8 W/ft ²

Room: 60'L x 8'W x 9.5'H

*Nominal value/4ft luminaire. **Excludes outer edges of space.

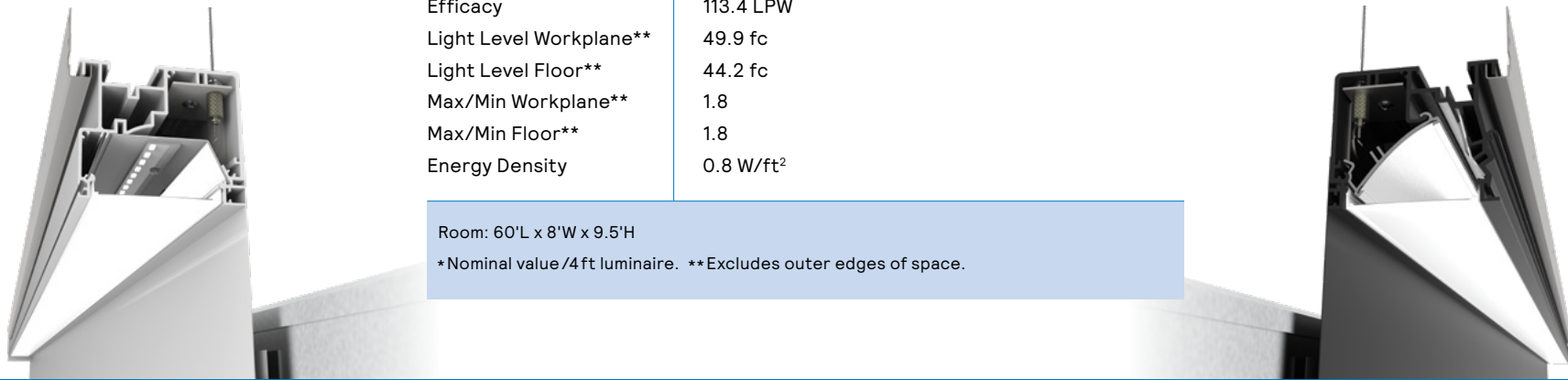

Ambient

TruGroove perimeter ambient delivers a gentle glow to the walls of the room and general work plane or floor illumination. MesoOptics® technology softens and controls stray light, particularly at the ends and corners. This minimizes hot spots and delivers efficacies up to 115 LPW.

Graze

TruGroove perimeter graze provides a tightly focused beam of light down the entire face of a textured wall, creating a dramatic lighting feature with industry leading efficacies up to 113 LPW and a top to bottom uniformity of 8:1 on a 9ft wall.



TruGroove cove

new

Cove with focus optics

Model: TC08L93520WN

Lumen Package*	2000lm (Inside Cove and Outside Cove)
Efficacy	121.9 LPW
Average Light Level	28.2 fc / 14.4 fc (Table / Full Room)
Max/Min Workplane	2.1 / 3.3 (Table / Full Room)
Energy Density	1.15 W/ft ²

Room: 12'L x 12'W x 10'H Cove: 10'H
Based on AccuRender CRI 90, 3500K color temperature
*Nominal value/4ft luminaire.



Focus

TruGroove cove with focus optics utilizes high efficiency Miro silver to minimize the back-light created and focus the light far into the room. Focus optics give you clean even illumination with efficacies up to 140 LPW .

Fill

TruGroove cove with fill optics utilizes white reflectors to "fill" the room with light. Fill optics are ideal for vaulted ceilings and applications where the cove and ceiling heights are spaced far apart.



Armstrong Formations™ Cloud shapes & sizes

2' x 2' Panels

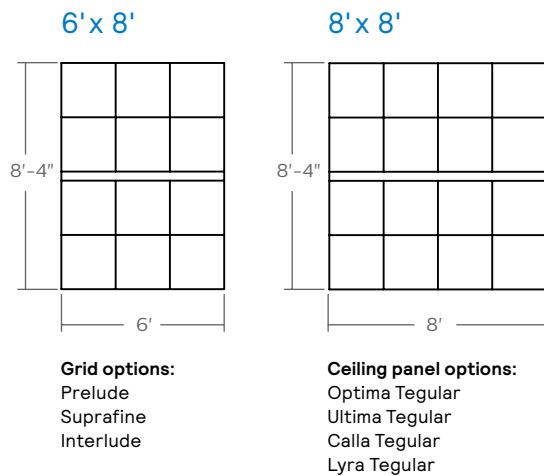

30" x 30" Panels

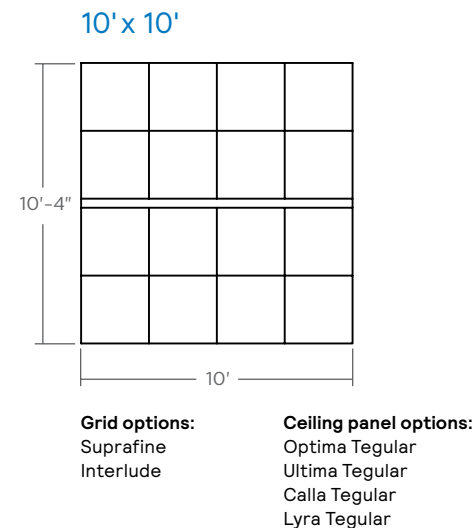

All clouds have a 4" wide opening in the center specifically designed for the integration of a Ledalite TruGroove recessed 3" luminaire.

Clouds must be ordered separately from TruGroove luminaires. Armstrong customer service is available to help with your project from start to finish.

To order Armstrong Formations Clouds, call 1-800-840-8521.

Innovative optics

Freeform elliptical optic

- Redirects light laterally from a central strip of LEDs into a wide batwing distribution in the upper hemisphere
- Minimizes max/min light levels on the ceiling
- Allows increased row spacing
- Homogenizes LED color temperature across all angles

Amazing asymmetric/wall wash

- Designed for wall or close to wall applications
- High performing specialized optics in both lower and upper hemispheres
- Fill the space with light or achieve a smooth gradation of light for wall washing vertical surfaces, avoiding light waste and obtrusive hotspots

MesoOptics DX

All symmetric TruGroove products use our latest generation MesoOptics DX technology, which is printed on both sides for beam shaping and diffusing to:

Purify

Homogenizes color and removes striations and hot spots from lighting sources, creating smooth gradients of pure, white light free from color shifts.

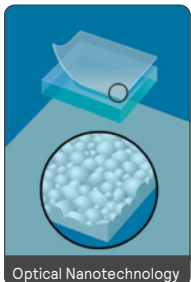

Sustain

Highly efficient material allows up to 95% of the light to pass through, creating highly energy efficient lighting products.

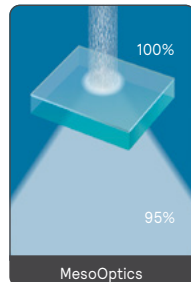
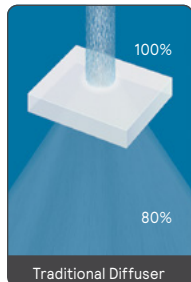

Control

Disperses light uniformly and creates precisely controlled beam patterns to redirect light into optimum angles.

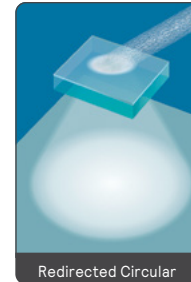
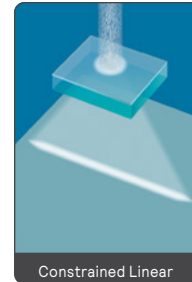

Freeform Elliptical Optic

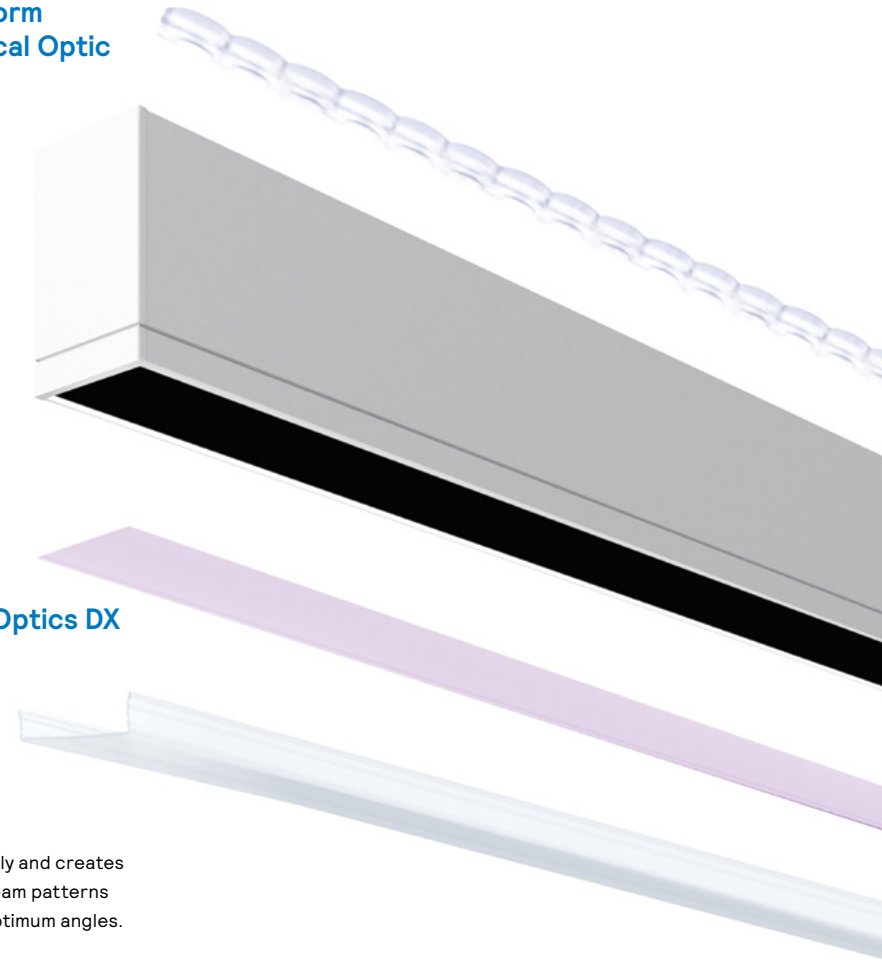

Various distributions

While all TruGroove product utilize MesoOptics technology, TruGroove micro products introduce a unique Quad Optic louver cell technology.

- Louvers may be combined with lenses for maximum application versatility
- Available with black/white or metallic (platinum/gold/copper) louver cells
- 6 tailored optical distributions for further reduction of glare

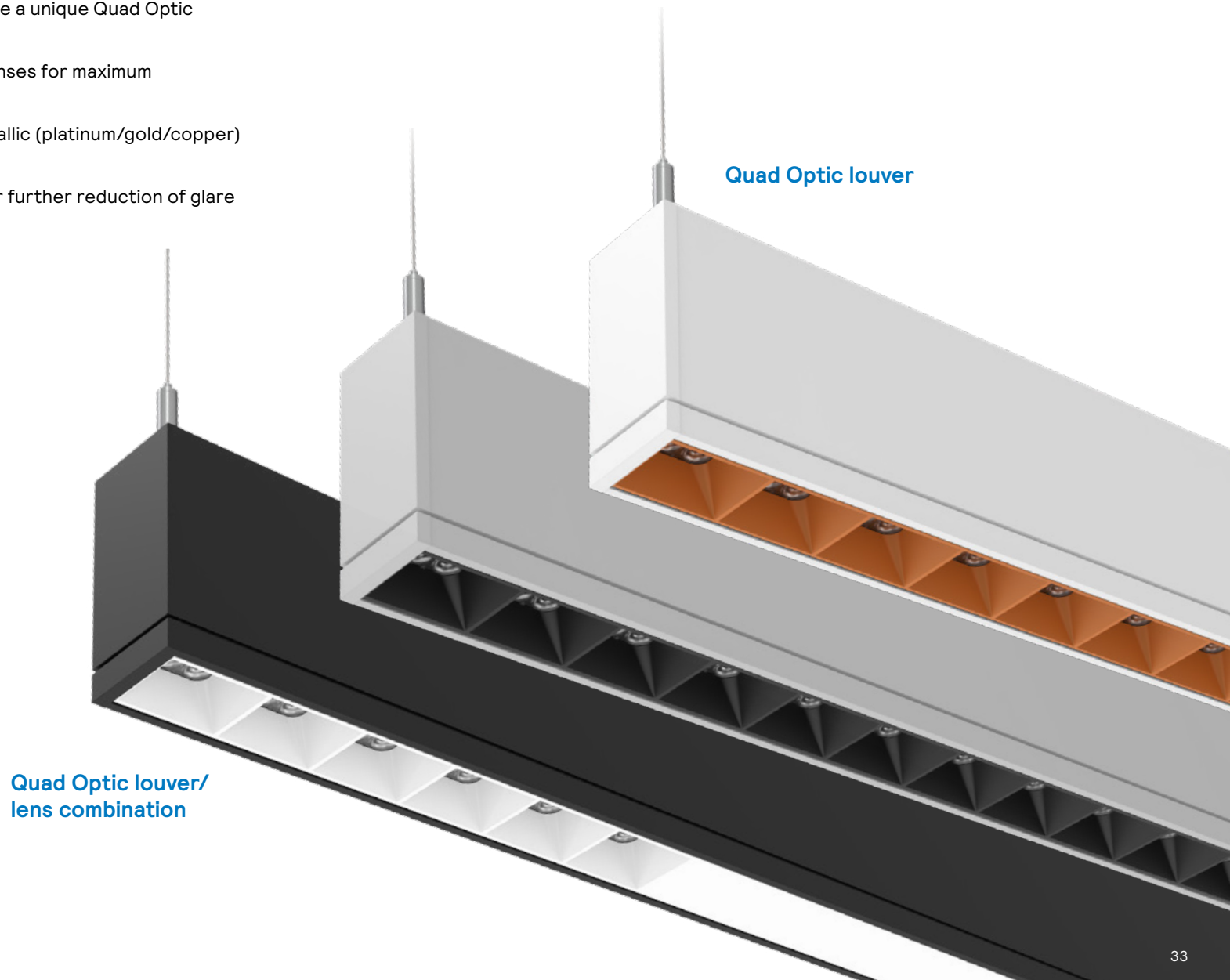

See the difference with AccuRender

Standard CRI 80



Good color rendering
and high efficacy

Standard CRI 90



Better color rendering
and low efficacy

AccuRender



Best color rendering,
color preference, and high efficacy

Note: Photos are for illustrative purposes only

TruGroove and Well v2 Lighting Concept

- ✓ Light Exposure and Education (precondition)
- ✓ Visual Lighting Design (precondition)
- ✓ Circadian Lighting Design (Max: 3 pts)
- ✓ Glare Control (Max: 3 pts)
- Enhanced Daylight Access (Max: 3 pts)
- ✓ Visual Balance (Max: 1 pt)
- ✓ Electric Light Quality Color Quality (Max: 2 pts)
- ✓ Occupant Control of Lighting Environments

Max: 12 points may be earned in the Light concept

- Preconditions (L01, L02) are mandatory for certification.
- Optimizations (L03 – L08) are optional pathways to achievement in WELL
- TruGroove's combination of spectral tuning & optical control contribute to L02, L03, L04, L06, and L07
- Also contributes to L08 when using control options



Enjoy design flexibility

Full range of products and options:

Available soon in across Ledalite portfolio for application flexibility

Multiple CCTs and lumen packages offered

Promote savings

High efficacy, with no penalty:

Energy efficacy compares well to conventional CRI 80

Up to 25% more energy savings vs competitor CRI 90¹

Helps you meet Title 24 requirements

Bolster wellbeing

High MDER:

AccuRender has a Melanopic Daylight Efficacy Ratio up to 0.80

Helps support Circadian Rhythm²

Earns points towards WELL Building Standard



Contribute to productivity

High MDER:

Supports daytime vitality³ and alertness⁴

Supports mood, thermo-regulation, and learning centers in the brain⁵

May positively influence work engagement by helping make the environment more attractive⁶

Achieve color balance

Best in class color consistency:

≤ 2 SDCM promotes aesthetic harmony in your space

Show your true colors

High color rendering:

CRI:

R_a up to 94, R_g up to 67,
 G_a up to 99, C_g up to 94

TM-30:

R_f up to 92, $R_{f,h1}$ up to 91,
 R_g up to 100, $R_{cs,h1}$ up to -5%

True to life colors to help energize your environment and render better flesh tones critical for Healthcare, Hospitality and Retail

¹ Based on comparison of published spec sheet data, most competitor offerings reflect a 15 to 25% efficacy loss for CRI 90 compared to CRI 80, while Ledalite AccuRender results in only $\leq 5\%$ drop compared to CRI 80.

² Czeisler, 1999; Dijk & Archer, 2009; Lucas 2012, 2019

³ Partonen 2000

⁴ Viola 2008, Smolders 2012; Geerdink 2017

⁵ Fernandez 2018; Rupp, 2019

⁶ Veitch, Jennifer & Stokkermans, Mariska & R. Newsham, Guy. (2013). Linking Lighting Appraisals to Work Behaviors. Environment and Behavior. 45. 198-214. 10.1177/0013916511420560.

It's all about control – Foundation → Advanced → Enterprise

Interact



Make the leap from smart lighting to super smart lighting

Connectivity is the future and key to unlock your smart building potential. Help boost your energy savings, reach your sustainability targets, and enhance occupancy comfort levels immediately from day one. Interact Pro is a connected system with wireless luminaire level controls and integral occupancy & daylight sensing.

Interact Pro scalable system

(CS sensor option code, an evolution of SpaceWise)

- Interact Pro offers three tiered functionality (Foundation → Advanced → Enterprise) to seamlessly align with your needs.
- The sensor works in the Foundation mode (similar to SpaceWise) when configured without a gateway or in an Interact Pro Advanced or Enterprise mode if a compatible gateway is used.
- Interact Pro includes an App, a portal and a broad portfolio of wireless luminaires, lamps and retrofit kits all working on the same system.
- Future proof your design and lay the right foundation
- Just add a gateway anytime and unlock more capabilities, no need to change or swap sensors
- Get a complete view of the 3 tiers and compatible products at:
interact-lighting.com/interactproscalablesystem

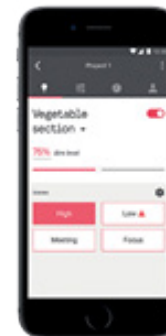

How are super savings delivered?

Adaptive dimming & dwell time feature enable the system to adapt to occupancy patterns in real time – delivering deep energy savings while maintaining occupancy comfort levels.

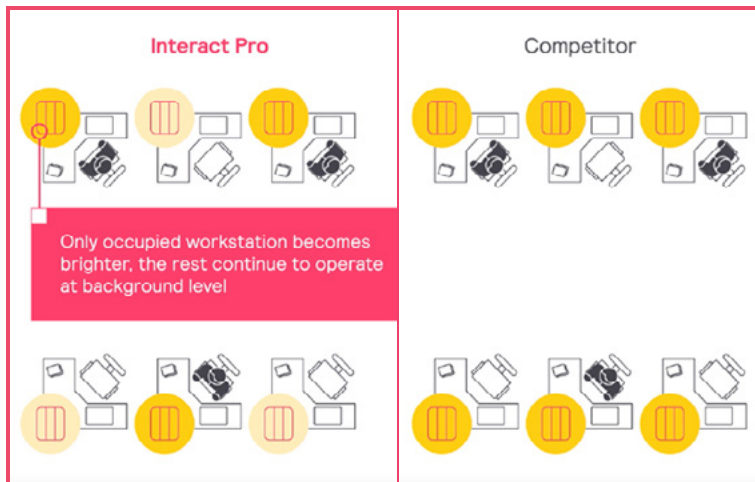

Adaptive Dimming

Up to 75%
Savings w/o
gateways

**Boost energy savings
up to 85%**
with gateways



Dwell Time

Note: TruGroove luminaires are also available with the following drivers: 0-10V 1% dim, DALI 5% dim, Lutron EcoSystem 1% dim, Xitanium Sensor Ready 1% dim, and are compatible with many 3rd party controls on request..

