

ignify



# Catalogue éclairage

Les gammes essentielles 2026

**PHILIPS**

ignify  
myCreation

ignify  
interact



signify

## Leader grâce à une technologie de pointe

Prenez la pole position grâce à l'éclairage LED performant et économe en énergie, conçu et produit par Signify

Ce n'est pas tous les jours que l'on a la chance de s'engager dans un partenariat avec un nom légendaire de la Formule 1. C'est pourquoi nous sommes ravis et fiers d'être le partenaire officiel de l'écurie Mercedes-AMG PETRONAS F1 Team pour l'éclairage.

Animés par une passion commune pour la technologie et le désir de repousser les limites du possible, nos innovations en matière d'éclairage servent l'ambition de l'équipe de devenir l'une des plus durables au monde dans le domaine du sport, contribuent au bien-être et à la performance des pilotes et offrent des expériences intenses aux fans.

### Nos marques globales

En tant que leader mondial de l'éclairage, notre objectif est de vous fournir des produits, des systèmes et des services performants pour l'éclairage. Grâce à notre largeur d'offre de lampes et de luminaires LED Philips, notre système d'éclairage connecté évolutif Interact et nos services Signify, créez, pour chaque application, un éclairage de haute qualité et économe en énergie.

PHILIPS

signify

signify  
interact

Pour en savoir plus sur le partenariat, nos solutions d'éclairage et nos services, consultez le site : [www.signify.com/fr-fr/partnership](http://www.signify.com/fr-fr/partnership)

### Une équipe d'experts pour gagner vos projets

Une étroite collaboration avant, pendant et après vos projets est essentielle à nos yeux. Nos équipes locales veillent à vous procurer le support et les informations dont vous avez besoin. Nous travaillons en étroite collaboration avec un réseau de distributeurs à travers toute la France afin de vous offrir des solutions flexibles et rapides, et une disponibilité de produits sur laquelle vous pouvez compter.

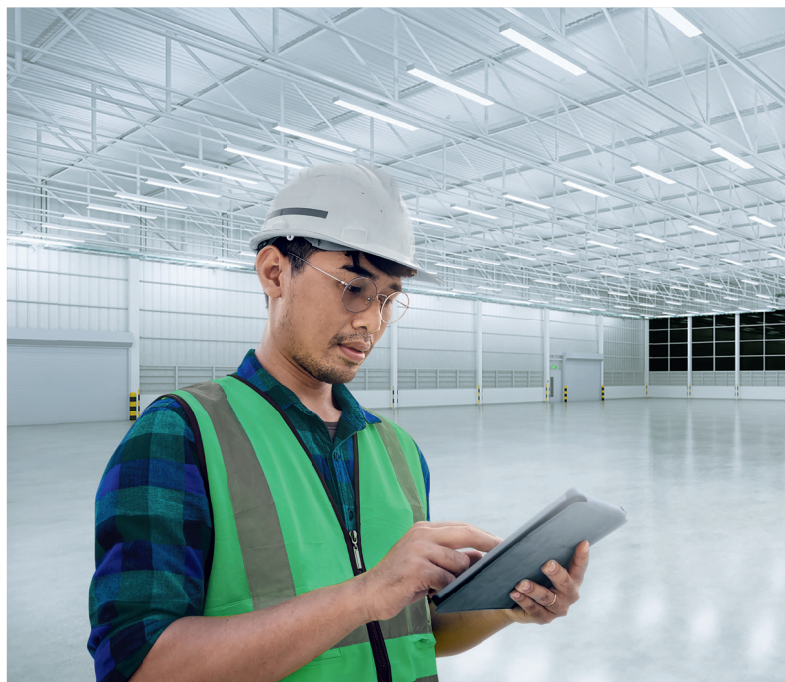

Signify est le partenaire officiel de Mercedes-AMG PETRONAS F1 Team pour l'éclairage

signify



Official Lighting Partner

AMG  
PETRONAS  
FORMULA ONE TEAM

# Sommaire visuel



**10**  
CoreLine  
Encastré



**12**  
CoreLine  
Panel



**14**  
Ledinaire  
Panel



**16**  
CoreLine  
Étanche



**18**  
Ledinaire  
Étanche All-in



**19**  
Ledinaire  
Étanche



**20**  
CoreLine  
tubulaire



**21**  
CoreLine  
Spots



**22**  
Ledinaire  
Spot All-in



**24**  
CoreLine  
Downlight



**26**  
CoreLine  
SlimDownlight



**27**  
Ledinaire  
SlimDownlight All-in



**28**  
CoreLine  
Réglette



**29**  
Ledinaire  
Réglette



**30**  
CoreLine  
Plafonnier



**31**  
Ledinaire  
Plafonnier All-in



**32**  
CoreLine  
Hublot



**33**  
Ledinaire  
Hublot All-in



**34**  
CoreLine  
Armature



**36**  
Ledinaire  
Armature All-in



**38**  
CoreLine Tempo  
Projecteur



**40**  
Ledinaire  
FloodLight All-in



**42**  
LumiStreet



**42**  
TownGuide



**44**  
Tubes LED



**48**  
Bulbs



**50**  
PLC LED



**50**  
Gu10

## L'éclairage connecté en toute simplicité avec Interact.



Plus d'informations en vidéo

L'éclairage connecté permet aux petites et moyennes entreprises de créer des environnements de travail plus confortables et sécuritaires. Il favorise ainsi la productivité et augmente les économies d'énergie afin d'atteindre les objectifs de développement durable.

Pour faciliter l'accès à l'éclairage intelligent, nous vous présentons la plateforme évolutive Interact. C'est une solution sans fil simple, rentable, et adaptée à tout type d'application.

La plateforme Interact est compatible avec une large gamme de lampes et luminaires Philips Interact ready.

### Intelligent



Un système flexible à 3 niveaux.  
Une solution adaptée à chaque besoin !

### Simple



Un luminaire ou une lampe  
+ un détecteur et/ou un interrupteur  
+ une appli : c'est tout ce dont vous avez besoin pour commencer !

### Évolutif



Évoluez facilement vers plus de fonctionnalités à tout moment !

## 3 étapes pour une installation d'éclairage réussie

1. Installez votre éclairage et vos détecteurs et interrupteurs Interact Ready
2. Téléchargez gratuitement l'application Signify Interact Builder
3. Connectez l'éclairage et les commandes à l'application Signify Interact Builder et configurez vos groupes et zones (ou scènes) d'éclairage.

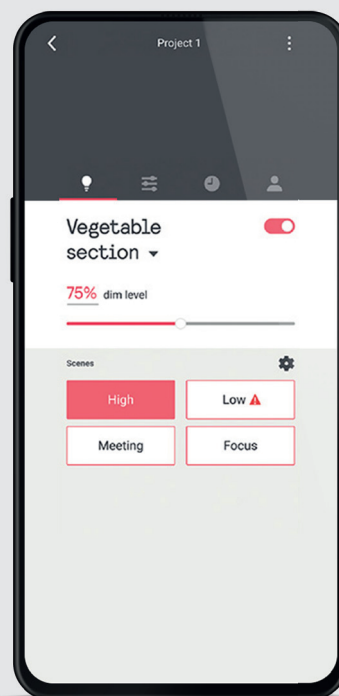

# 3 niveaux d'Interact en fonction des besoins

## Niveau 1 : Interact Foundation

- Installez et branchez des luminaires intelligents.
- Ajoutez, si besoin, à l'installation des détecteurs de présence et de luminosité et/ou des interrupteurs sans fil Interact ready.
- Paramétrez-les via Bluetooth avec l'application intuitive Signify Interact Builder.
- Les luminaires, détecteurs et interrupteurs communiquent ensuite entre eux en Zigbee.
- Bénéficiez d'une gestion de votre éclairage automatisée et optimisée sans complexifier la mise en service : installation simple sans câblage additionnel.

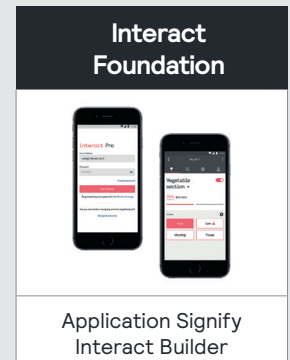

## Niveau 2 : Interact Advanced

- Ajoutez simplement une passerelle et bénéficiez des avantages du cloud.
- Créez des scénarios et pilotez votre éclairage grâce à votre smartphone.
- Accédez à distance au suivi de votre éclairage en temps réel pour surveiller et adapter votre consommation énergétique.
- Accédez à des tableaux de bord contenant des informations sur la durée de vie et la santé de l'installation, pour une maintenance préventive efficace.

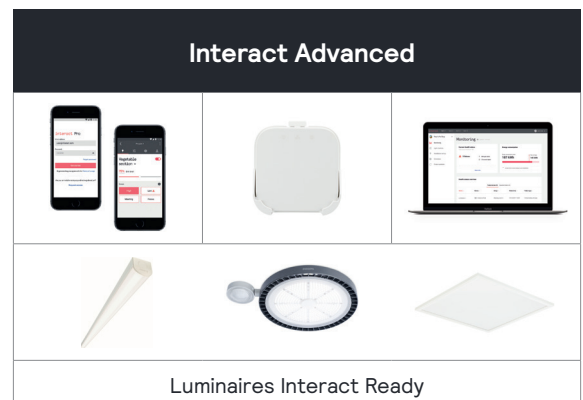

## Niveau 3 : Interact Enterprise

Ce niveau nécessite une formation spécifique

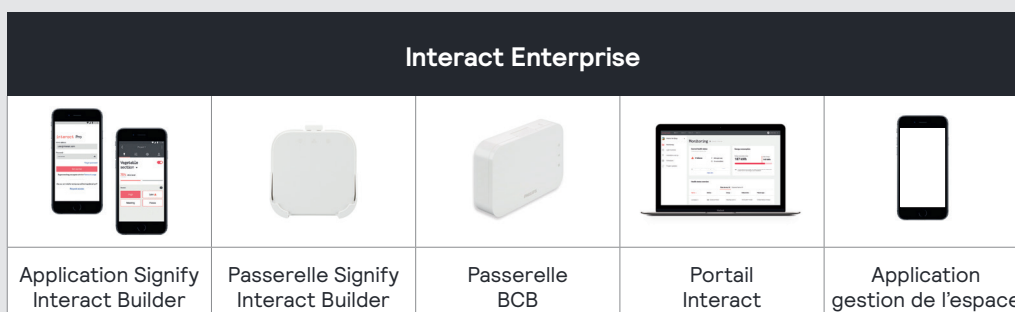

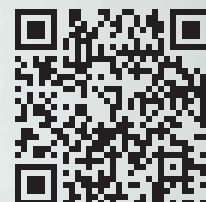

Découvrez le configurateur, pour créer vos luminaires imprimés en 3D avec au moins 75% de polycarbonate recyclé

Des millions de possibilités, à vous de jouer

### Encastré

### Plafonnier



Essential



GreenSpace  
Perfect fit



Accent  
Recessed  
D65



Accent  
Semi-Recessed  
D65



Ambifit



Essential



Drum



Accent  
Surface  
Mounted D65

### Suspension



Gleam



Cloak



Blossom



Grand



Smooth  
Cylinder



Accent  
Cylinder D65



Essential



Drum



Highlight



Puzzle



Dome



Original



Industrial



Cord



Jewels  
Smokey Grey



First

### Luminaire sur rail

### Applique



Jewels Water  
Blue



Smooth  
track



Accent  
track D65



Accent  
track D90



Drum



Accent Wall  
D65



Essential





# GreenSpace perfect fit

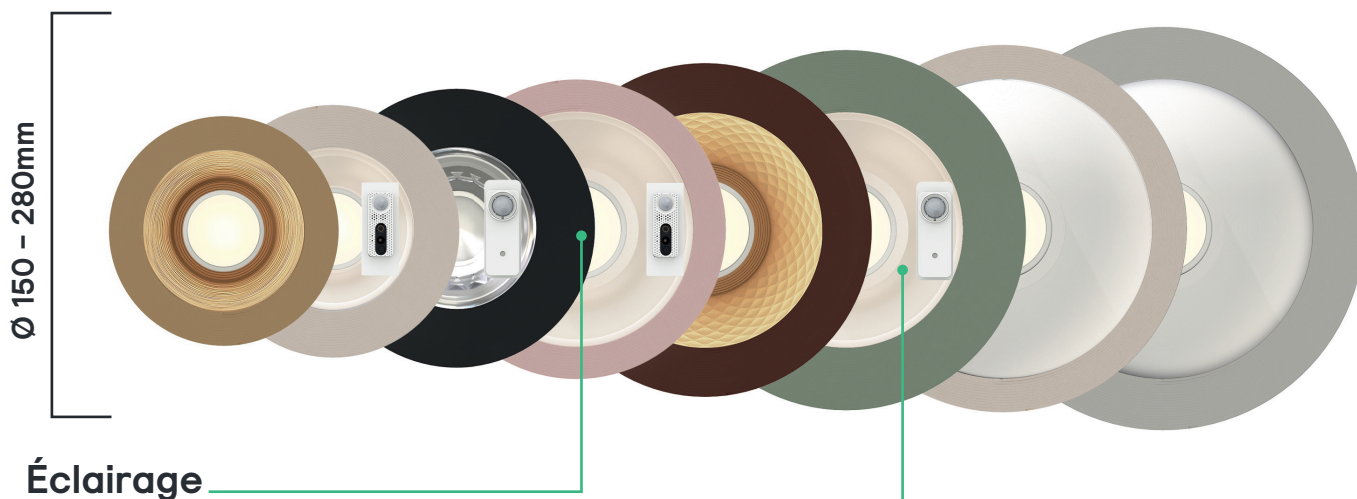

## Température de couleur

- 3 000 K
- 4 000 K
- Tunable White
- 2 700 K-6 500 K

## IRC

- 80
- 90 Premium White

## Confort

- UGR19
- UGR22
- UGR25

## Capteurs de présence/luminosité

- U4 - SC200
- U5 - SC1500

## Flux

- 700 lm
- 1 100 lm
- 1 400 lm
- 2 000 lm
- 3 000 lm
- 4 000 lm
- 5 000 lm

## Efficacité

- Jusqu'à 162 lm/W

## Drivers

- On-Off (PSU-E)
- DALI DCDIM (PSD-E)
- DIA-E
- Connexion sans fil au système Interact avec capteur intégré (SIA-E) et sans capteur intégré (WIA-E)

## Accessoires et Options

- Verre de fermeture en polycarbonate clair (PCC)
- Verre de fermeture opale (PCO) IP54

## Optiques



## Options de câblage



## Finitions standard

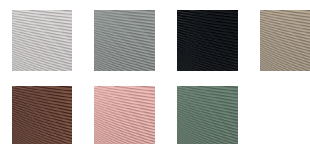

## Aide à l'installation

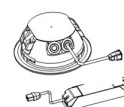

DC Plug



Film anti-poussière



# CoreLine Encastré gen4 RC136B G4



5 ans IP20/44 IK03

**PHILIPS** **interact**



Version rectangulaire



Finition soignée pour un rendu haut-de-gamme et vasque microprismatique sur les versions UGR19 pour un excellent confort

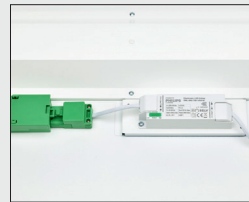

Connecteur clipsable, compatible Wieland, avec repiquage pour une installation rapide et sans outils.

## Schémas techniques

Version carrée

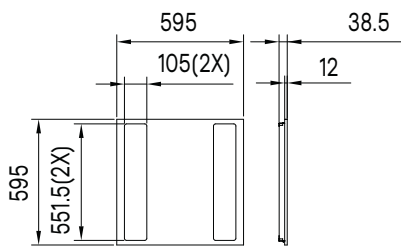

Version rectangulaire

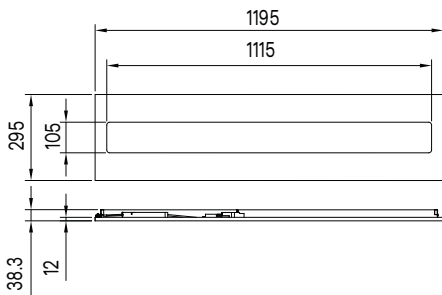

Dimensions en mm

## Caractéristiques techniques

IRC	80
Diffuseur	Microprismatique
Chromaticité initiale	SDCM<3
Classe électrique	II
Risque photobiologique	RG0
Temp. de fonctionnement	-10°C à +40°C
Résistance au feu	650°C
ENEC	Oui



## Choix de votre référence

Dim	Gradation	UGR	Temp couleur	Flux	Puissance	Rendement	Code
Carré 600x600mm	On/Off	UGR19	4000K	3600 / 4500 / 6000 lm	23 / 29 / 38,5W	157 lm/W	764163
		UGR22	4000K	3600 / 4500 / 6000 lm	23 / 29 / 38,5W	157 lm/W	764156
	DALI-2	UGR19	3000K	3400 / 4300 / 5700 lm	23 / 29 / 38,5W	148 lm/W	764125
			4000K	3600 / 4500 / 6000 lm	23 / 29 / 38,5W	157 lm/W	764149
	Signify Interact	UGR19	3000K	4000 lm	27,5W	145 lm/W	764170
			4000K	4300 lm	27,5W	156 lm/W	764194
Rectangulaire 1200x300mm	DALI-2	UGR19	3000K	3400 / 4300 / 5700 lm	23 / 29 / 38,5W	148 lm/W	764118
			4000K	3600 / 4500 / 6000 lm	23 / 29 / 38,5W	157 lm/W	764132
	Signify Interact	UGR19	4000K	4300 lm	27,5W	156 lm/W	764187

# CoreLine Panel gen6 RC132V G6



5 ans



IP65



IK03

**PHILIPS** **interact**



Version rectangulaire



Multicapteur présence et luminosité



Connecteur clipsable, compatible Wieland, avec repiquage pour une installation rapide et sans outils.



Finition soignée pour un rendu haut-de-gamme et vasque microprismatique sur les versions UGR19 pour un excellent confort

## Schémas techniques

Version carrée

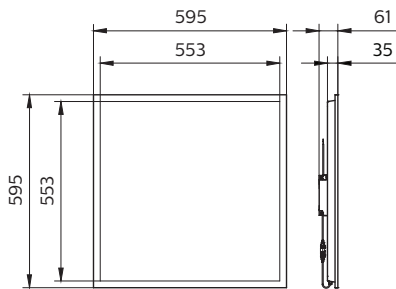

Version rectangulaire

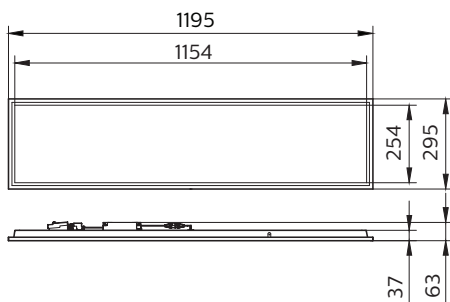

Dimensions en mm

## Caractéristiques techniques

IRC	80
Diffuseur	Microprismatique
Chromaticité initiale	SDCM<3
Classe électrique	II
Risque photobiologique	RGO
Temp. de fonctionnement	-10°C à +35°C
Résistance au feu	650°C
ENEC	Oui



## Choix de votre référence

Dim	UGR	Gradation	Temp couleur	Flux	Puissance	Rendement	Code	
Carré 600x600mm	UGR19	On/Off	3000K	3400 lm	26 W	131 lm/W	751347	
			3000K / 4000K	2900 / 3600 / 4300 lm	22W / 31W	141 lm/W	735187	
			4000K	3600 lm	26 W	138 lm/W	735125	
		DALI-2	3000K / 4000K	2900 / 3600 / 4300 lm	22W / 31W	141 lm/W	735194	
				4000K	3600 lm	26 W	138 lm/W	735156
			Signify Interact	3000K	3400 lm	26 W	131 lm/W	749993
		4000K		3600 lm	31W	138 lm/W	750005	
				4300 lm		139 lm/W	750029	
		Signify Interact avec capteur intégré	3000K	4000 lm	32 W	125 lm/W	588608	
			4000K	4300 lm		134 lm/W	588592	
		UGR22	On/Off	3000K	3400 lm	26 W	131 lm/W	751330
				3000K / 4000K	2900 / 3600 / 4300 lm	22W / 31W	141 lm/W	749900
	4000K			3600 lm	26 W	138 lm/W	735095	
	Carré 600x600mm IP65	UGR19	On/Off	4000K	4800 lm	45 W	107 lm/W	735613
			DALI-2		3600 lm		138 lm/W	735149
Rectangulaire 1200x300mm	DALI-2		3000K / 4000K	2900 / 3600 / 4300 lm	22W / 31W	141 lm/W	749894	
		4000K	3600 lm	138 lm/W		735170		
	Signify Interact	3000K	4000 lm	32W	125 lm/W	835245		
	Signify Interact avec capteur intégré	4000K	4300 lm	32 W	134 lm/W	835238		
			3600 lm	26 W	138 lm/W	735118		
	UGR22	On/Off	4000K	3600 lm	26 W	138 lm/W	735118	

## Accessoires

Accessoires	Code
<b>Accessoires Montage</b>	
Cadre saillie 300x1200 (installation rapide) compatible tout panel	752160
Cadre saillie 600x600 (installation rapide) compatible tout panel	752146
Cadre saillie 600x600mm (montage vis) compatible tout panel	752177
Cadre saillie 300x1200mm (montage à vis) compatible tout panel	752191
Clips pour montage dans faux-plafond plâtre compatible tout panel	752481
Kit de suspension (câble inclus) compatible tout panel PSU / WIA / SIA	752504
<b>Accessoires Interact</b>	
Interface Piezo sans fil INTERACT Ready UID8480 2 boutons	273771
Interface Piezo sans fil INTERACT Ready UID8480 4 boutons pour rappel de scènes	273801
Détecteur Présence INTERACT READY IP42 Blanc sans fil Occupation seulement	260597
<b>Accessoires Décoratifs</b>	
Accessoire déco Panel 600x600 Carré, Paquet de 5	799281
Accessoire déco Panel 600x600 Carré double, Paquet de 5	799298
Accessoire déco Panel 600x600 Cercle, Paquet de 5	799304

# Ledinaire Panel RC065B



5 ans



IP40



IK02

PHILIPS



121  
lm/W  
max



Version rectangulaire



Connecteur pour une installation rapide et sans outils.



Réglage facile de la température de couleur via le commutateur intégré au driver

## Schémas techniques

Version carrée

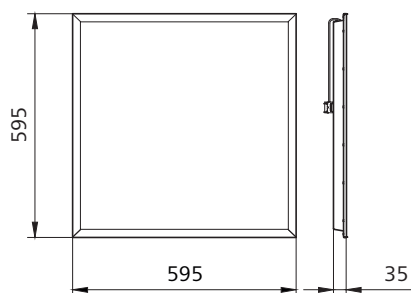

Version rectangulaire

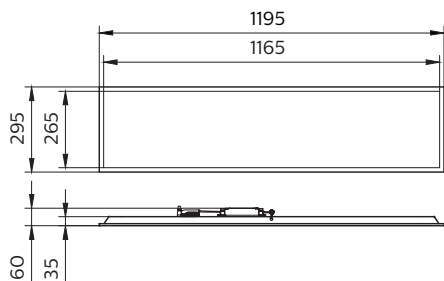

Dimensions en mm

## Caractéristiques techniques

IRC	80
Diffuseur	Microprismatique
Chromaticité initiale	SDCM<5
Classe électrique	II
Risque photobiologique	RGO
Temp. de fonctionnement	-10°C à +35°C
Résistance au feu	650°C





## Choix de votre référence

Dim	UGR	Gradation	Temp couleur	Flux	Puissance	Rendement	Code	
Carré 600x600mm	UGR19	On/Off	3000K / 4000K	3600 lm	30 W	120 lm/W	516724	
			4000K	3400 lm	28 W	121 lm/W	516526	
		516939 Pack de 6 panels						
		DALI-2	3000K / 4000K	3600 lm	30 W	120 lm/W	516977	
	4000K		3400 lm	28 W	121 lm/W	516588		
	UGR22	On/Off	4000K	3400 lm	28 W	121 lm/W	516557	
Rectangulaire 1200x300mm	UGR19	On/Off	3000K / 4000K	3600 lm	30 W	120 lm/W	516984	

Accessoires	Code
<b>Accessoires Montage</b>	
Cadre saillie 300x1200 (installation rapide) compatible tout panel	752160
Cadre saillie 600x600 (installation rapide) compatible tout panel	752146
Cadre saillie 600x600mm (montage vis) compatible tout panel	752177
Cadre saillie 300x1200mm (montage à vis) compatible tout panel	752191
Clips pour montage dans faux-plafond plâtre compatible tout panel	752481
Kit de suspension (câble inclus) compatible tout panel PSU / WIA / SIA	752504
<b>Accessoires Décoratifs</b>	
Accessoire déco Panel 600x600 Carré, Paquet de 5	799281
Accessoire déco Panel 600x600 Carré double, Paquet de 5	799298
Accessoire déco Panel 600x600 Cercle, Paquet de 5	799304

# CoreLine Étanche gen3 WT120C



5 ans



IP66



IK08

**PHILIPS** **interact**



**188**  
lm/W  
max



Vasque en polycarbonate à faisceau large



Nouveau connecteur externe Push-in, pour gagner jusqu'à 25% de temps d'installation



Accessoires inclus : étriers de fixation, vis anti-vandalisme, presse-étoupe et passe-câble étanche



Etriers de fixation ajustables sur 30 cm de chaque côté du luminaire

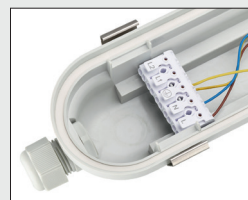

Connecteur Push-in pour une installation facile et sans outils

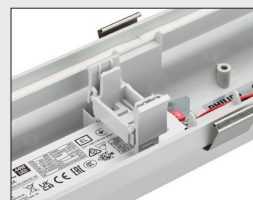

Remplacement des pièces détachées facile et sans outils

## Schémas techniques

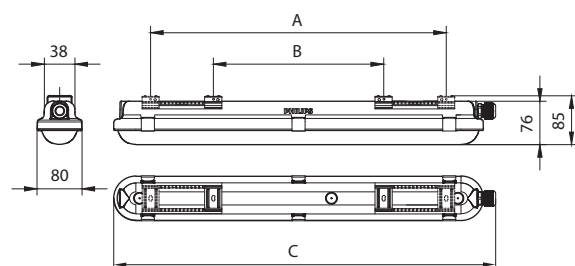

Dimensions en mm	A	B	C
L600	512 max	308 min	665
L1200	1062 max	538 min	1215
L1500	1362 max	838 min	1515

Dimensions en mm

## Caractéristiques techniques

IRC	80
Chromaticité initiale	SDCM<3
Classe électrique	I
Risque photobiologique	RG0
Temp. de fonctionnement	-20°C à +40°C
Résistance au feu	850°C
ENEC	Oui



## Choix de votre référence

Dim	Temp couleur	Faisceau	Gradation	Installation	Flux	Puissance	Rendement	Code	
Longueur 600mm	4000K	110°	On/Off	standard	2000 lm	13 W	154 lm/W	333056	
			DALI-2		4000 lm	25 W	160 lm/W	359902	
			Détecteur de mouvement intégré		2000 lm	13 W	154 lm/W	359827	
Longueur 1200mm			standard	2700 lm	17 W	159 lm/W	333063		
				4000 lm	25 W	160 lm/W	333087		
				On/Off	Connecteur rapide externe push-in	4000 lm	25 W	160 lm/W	333216
					Connecteur rapide externe push-in traversant	4000 lm	25 W	160 lm/W	333223
					standard	4200 lm	22,5 W	187 lm/W	359971
				6000 lm		37,5 W	160 lm/W	333124	
				8000 lm		50 W	160 lm/W	333131	
				DALI-2	standard	6000 lm	37,5 W	160 lm/W	333360
				Détecteur de mouvement intégré	standard	2700 lm	17 W	159 lm/W	359834
						4000 lm	25 W	160 lm/W	333285
					Câblage traversant	2700 lm	17 W	159 lm/W	359865
						4000 lm	25 W	160 lm/W	359889
Signify Interact	standard	8000 lm	50 W	160 lm/W	359933				
Longueur 1500mm	standard	On/Off	standard	3400 lm	21,5 W	158 lm/W	333070		
				6000 lm	37,5 W	160 lm/W	333094		
				Connecteur rapide externe push-in	6000 lm	37,5 W	160 lm/W	333230	
		standard	Connecteur rapide externe push-in traversant	6000 lm	37,5 W	160 lm/W	333247		
			6000 lm	32 W	188 lm/W	359988			
			8000 lm	50 W	160 lm/W	333100			
			10 000 lm	62,5 W	160 lm/W	333148			
		DALI-2	standard	12 000 lm	75 W	160 lm/W	333155		
				8000 lm	50 W	160 lm/W	333391		
				8200 lm	44 W	186 lm/W	390011		
		Détecteur de mouvement intégré	standard	3400 lm	21,5 W	158 lm/W	359841		
				6000 lm	37,5 W	160 lm/W	333292		
				8000 lm	50 W	160 lm/W	359858		
			Câblage traversant	3400 lm	21,5 W	158 lm/W	359872		
				6000 lm	37,5 W	160 lm/W	359896		
Signify Interact	standard	8000 lm	50 W	160 lm/W	359964				

# Ledinaire Étanche All-in WT065C



5 ans



IP65



IK08

PHILIPS



146  
lm/W  
max

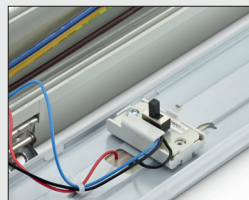

Réglage facile de la puissance via le commutateur intégré

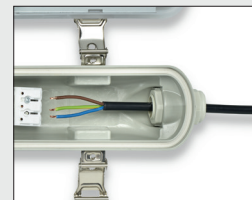

Connecteur Push-in pour une installation facile et sans outil

## Caractéristiques techniques

IRC	80
Chromaticité initiale	SDCM<5
Classe électrique	I
Risque photobiologique	RG1
Temp. de fonctionnement	-20°C à +40°C
Résistance au feu	850°C

## Schémas techniques

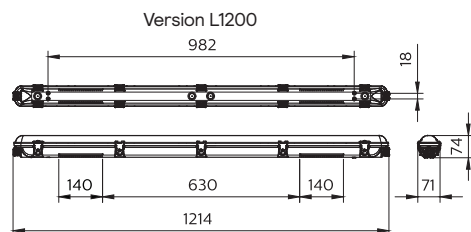
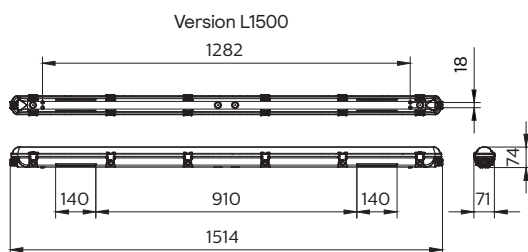

Dimensions en mm

## Choix de votre référence

Dimension	Gradation	Temp couleur	Flux	Puissance	Rendement	Installation	Code
Longueur 1200 mm	On / Off non gradable	4000K	Multi lumen 2900-4800 lm	23 W / 42 W	126 / 114 lm/W	Traversant, à clips, connecteur interne	500235
Longueur 1500 mm			Multi lumen 4100-6800 lm	28 W / 50 W	146 / 136 lm/W		500242

# Ledinaire Étanche WT060C



5 ans



IP66



IK08

**PHILIPS**



Connecteur externe à bascule



Accessoires de poses inclus

## Caractéristiques techniques

IRC	80
Chromaticité initiale	SDCM<5
Classe électrique	I
Risque photobiologique	RG0
Temp. de fonctionnement	-20°C à + 45°C
Résistance au feu	850°C

## Schémas techniques

version L600

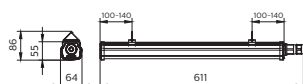

version L1200

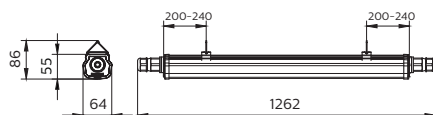

version L1500

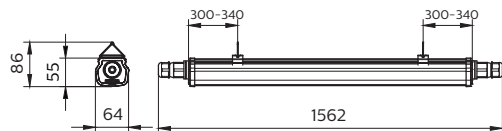

Dimensions en mm



## Choix de votre référence

Dimension	Gradation	Temp couleur	Faisceau	Flux	Puissance	Rendement	Installation	Code
Longueur 600mm	On/Off	4000K	120°	1800 lm	15 W	120 lm/W	Non traversant, connecteur externe	360072
Longueur 1200mm				3600 lm	30 W		Traversant / connecteur Externe	360102
Longueur 1500mm				5600 lm	46 W			360126

# CoreLine Étanche tubulaire gen2 WT210C

100 000h  
L80



5 ans



IP68



IK10

**PHILIPS**

161  
lm/W  
max



Connecteur externe rapide traversant par défaut.



Embout en Inox 316



Accessoires de suspensions en option

## Schémas techniques

Version 1200mm

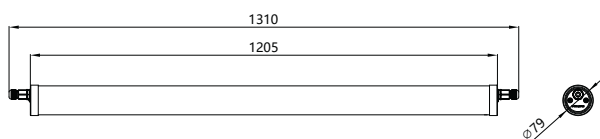

Version 1500mm

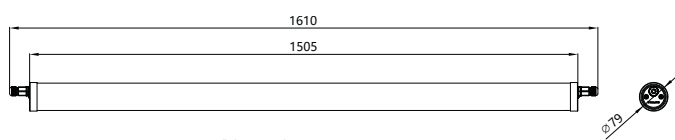

Dimensions en mm

## Caractéristiques techniques

IRC	80
Chromaticité initiale	SDCM<3
Classe électrique	I
Risque photobiologique	RG0
Temp. de fonctionnement	-20°C à +40 °C
Résistance au feu	850°C
ENEC	Oui

## Choix de votre référence

Dim	Installation	UGR	Gradation	Faisceau	Puissance	Temp couleur	Flux	Rendement	Code
Longueur 1200mm	Câblage traversant	UGR30	On/Off	120°	31 W	3000K	4650 lm	150 lm/W	329677
						4000K	5000 lm	161 lm/W	329639
Longueur 1500mm					43,5 W	3000K	6600 lm	152 lm/W	329684
						4000K	7000 lm	161 lm/W	329646

### Accessoires

Chaines de suspension compatibles pour les installation en intérieur et extérieur

329653

Filin de suspension compatible pour les installations en intérieur uniquement

329660



# Spots CoreLine RS155/RS156



5 ans

IP65

IK02

**PHILIPS** **interact**



Version fixe  
finition Blanc RAL 9003



Version fixe  
finition Aluminium



Version orientable  
finition Blanc RAL 9003



Version orientable  
finition Aluminium

## Schémas techniques

Version fixe



Ø 68

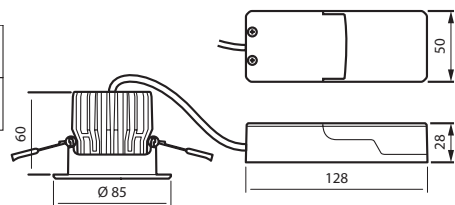
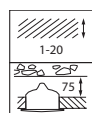

Version orientable



Ø 68

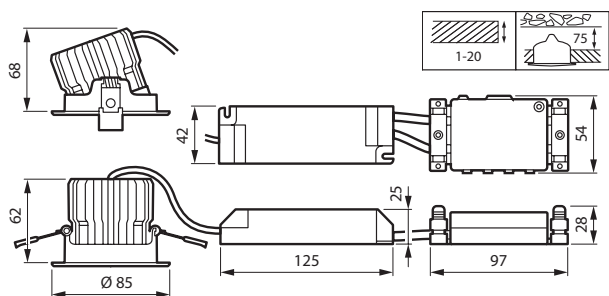

Dimensions en mm

## Caractéristiques techniques

IRC	80
Chromaticité initiale	SDCM<5
Classe électrique	II
Risque photobiologique	RG1
Temp. de fonctionnement	0° à + 35°C
Résistance au feu	650°C
Recouvrable	oui
Compatible RE2020	oui
ENEC	oui

## Choix de votre référence

Couleur	Gradation	Faisceau	Temp couleur	Fixe / Orientable	IP	Flux	Puissance	Rendement	Code		
Alu	Gradable coupure fin de phase	36°	2700K	Fixe	IP20/65	720 lm	7,2 W	100 lm/W	941694		
				Orientable	IP20/44				940833		
			3000K	Fixe	IP20/65	750 lm	7,2 W	104 lm/W	940987		
						1000 lm	10,2 W	98 lm/W	941014		
						1300 lm	12,3 W	106 lm/W	941045		
				Orientable	IP20/44	750 lm	7,2 W	104 lm/W	940802		
						1000 lm	10,2 W	98 lm/W	940864		
						1300 lm	12,3 W	106 lm/W	940901		
			4000K	Fixe	IP20/65	800 lm	7,2 W	111 lm/W	941687		
						800 lm	7,2 W	111 lm/W	940826		
				Orientable	IP20/44	1080 lm	10,2 W	106 lm/W	940888		
						1380 lm	12,3 W	112 lm/W	940925		
Blanc	Gradable coupure fin de phase	36°	3000K	Fixe	IP20/65	750 lm	7,2 W	104 lm/W	940970		
						1000 lm	10,2 W	98 lm/W	941007		
						1300 lm	12,3 W	106 lm/W	941038		
				Orientable	IP20/44	750 lm	7,2 W	104 lm/W	940796		
						1000 lm	10,2 W	98 lm/W	940857		
						1300 lm	12,3 W	106 lm/W	940895		
			4000K	Fixe	IP20/65	800 lm	7,2 W	111 lm/W	940994		
						1080 lm	10,2 W	106 lm/W	941021		
						1380 lm	12,3 W	112 lm/W	941052		
				Orientable	IP20/44	800 lm	7,2 W	111 lm/W	940819		
						1080 lm	10,2 W	106 lm/W	940871		
						1380 lm	12,3 W	112 lm/W	940918		
			DALI-2	36°	3000K	Orientable	IP20/44	1300 lm	12,3 W	106 lm/W	940956
					4000K			1380 lm			112 lm/W
			Signify Interact	36°	3000K	Orientable	IP20/44	1300 lm	12,3 W	106 lm/W	940932
					4000K			1380 lm			112 lm/W



# CoreLine Downlight DN142B

50 000h  
L80



5 ans



IP54



IK02

**PHILIPS**  **interact**

122  
lm/W  
max



Version réflecteur aluminium UGR19



Version réflecteur blanc UGR25



Connecteur Push-in pour une installation facile et sans outil

## Schémas techniques

Version Mini

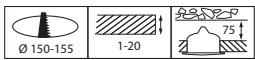

Version Compact

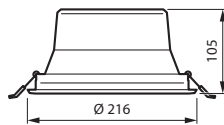
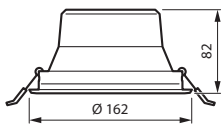
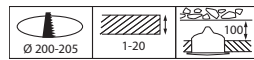

Dimensions en mm

## Caractéristiques techniques

IRC	80
Chromaticité initiale	SDCM<5
Classe électrique	II
Risque photobiologique	RG1
Temp. de fonctionnement	-20°C à +35°C
Résistance au feu	650°C



## Choix de votre référence

Type	Dim	Dim encastr.	IP	UGR	Gradation	Temp couleur	Flux	Puissance	Rendement	Code
Encastré (profondeur mini 82 mm)	Ø 162 mm	Ø 150 mm	IP20	UGR19 (refl Alu)	On/Off	3000K	1200 lm	9,8 W	122 lm/W	503038
						4000K				502994
						3000K				503052
						4000K				503014
				UGR25 (refl Blanc)	DALI-2	3000K	1150 lm	10,7 W	108899	
						4000K			108936	
						3000K			108875	
						4000K			108912	
			IP20/54	UGR19 (refl Alu)	On/Off	3000K	1200 lm	9,8 W	503021	
						4000K			502987	
						3000K			503045	
						4000K			503007	
				UGR25 (refl Blanc)	DALI-2	3000K	1200 lm	10,7 W	108882	
						4000K			108929	
						3000K			108882	
						4000K			108929	
	Ø 216 mm	Ø 200 mm	IP20	UGR19 (refl Alu)	On/Off	3000K	2300 lm	19,2 W	120 lm/W	502956
						4000K				502918
						3000K				502970
						4000K				502932
				UGR25 (refl Blanc)	DALI-2	3000K	2300 lm	20,5 W	108974	
						4000K			109018	
						3000K			108950	
						4000K			108998	
			IP20/54	UGR19 (refl Alu)	On/Off	3000K	2300 lm	19,2 W	502949	
						4000K			502901	
						3000K			502963	
						4000K			502925	
				UGR25 (refl Blanc)	DALI-2	3000K	2300 lm	20,5 W	108981	
						4000K			109025	
						3000K			108967	
						4000K			109001	
UGR19 (refl Alu)	Signify Interact	3000K	2300 lm	20,4 W	109124					
		4000K			109148					
		3000K			109117					
		4000K			109131					
UGR25 (refl Blanc)	Signify Interact	3000K	2350 lm	20,4 W	109117					
		4000K			109131					
		3000K			109117					
		4000K			109131					

# CoreLine SlimDownlight DN145B



5 ans



IP44



IK02

**PHILIPS** **Signify**  
**interact**



Épaisseur d'encastrement de 32 mm



Réglage facile de la température de couleur via le commutateur intégré



Accessoire plafonnier compatible avec les diamètres 166 et 215 mm



Connecteur Push-in pour une installation facile et sans outils

## Schémas techniques

Version Ø 90

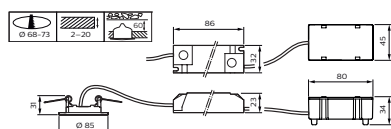

Version Ø 170

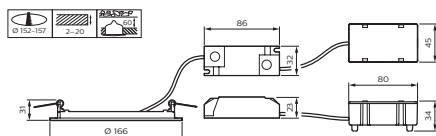

Version Ø 218

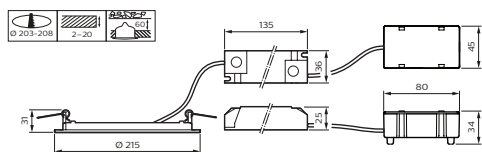

Dimensions en mm

## Caractéristiques techniques

IRC	80
Chromaticité initiale	SDCM<3
Classe électrique	II
Risque photobiologique	RG0
Temp. de fonctionnement	-20°C à +40°C
Résistance au feu	650°C
ENEC	Oui

## Choix de votre référence

Type	Dim	Dim encastr.	IP	Temp couleur	Faisceau	UGR	Gradation	Flux	Puissance	Rendement	Code
Encastré Slim (profondeur 25mm)	Ø 90mm	Ø 80mm	IP20/44	3000 / 4000K	90°	UGR33	On/Off	700 lm	6,5 W	110 lm/W	500402
							On/Off			120 lm/W	500419
	Ø 170mm	Ø 155mm				UGR28	DALI-2	1150 lm	9,5 W	115 lm/W	316998
							Signify Interact			317018	
	Ø 218mm	Ø 205mm				UGR28	On/Off	2100 lm	17,5 W	120 lm/W	500426
							Signify Interact			117 lm/W	317025
			DALI-2			120 lm/W	317001				

### Accessoires

Accessoire pour montage plafonnier compatible avec les dimensions 170mm

317032

Accessoire pour montage plafonnier compatible avec les dimensions 218mm

317049

# Ledinaire SlimDownlight DN065B



5 ans



IP44



IK03

PHILIPS



Réglage facile de la température de couleur via le commutateur intégré

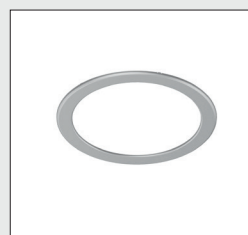

Collerette Argent

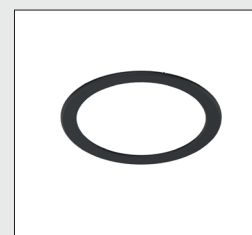

Collerette Noire

## Schémas techniques

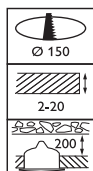

SlimDownlight gen4 Mini All-in

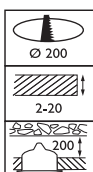

SlimDownlight gen4 Compact All-in

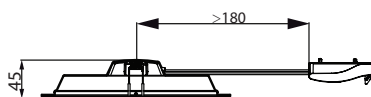

Dimensions en mm

## Caractéristiques techniques

IRC	80
Chromaticité initiale	SDCM<5
Classe électrique	II
Risque photobiologique	RG0
Temp. de fonctionnement	-20°C à +40°C
Résistance au feu	650°C
Recouvrable	oui

## Choix de votre référence

Type	Dim	Dim encastr.	IP	UGR	Gradation	Temp couleur	Flux	Puissance	Rendement	Code
Encastré Slim (profondeur 45mm)	Ø 175mm	Ø 150mm	IP44	UGR28	On/Off	3000 / 4000 / 6500K	1200 lm	12 W	100 lm/W	464438
	Ø 225mm	Ø 200mm					2000 lm	19 W	105 lm/W	464452

# CoreLine Reglette BN126C



5 ans IP20/40 IK04



PHILIPS



Mise en ligne de plusieurs réglettes (jusqu'à 10 réglettes) ou point par point



Réglage facile de la puissance via le commutateur intégré

## Schémas techniques

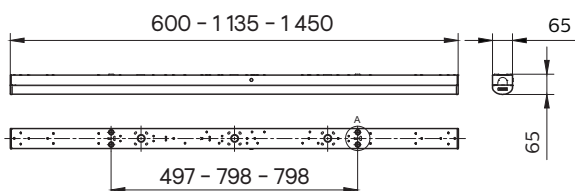

Dimensions en mm

## Caractéristiques techniques

IRC	80
Chromaticité initiale	SDCM<3
Classe électrique	I
Risque photobiologique	RG0
Temp. de fonctionnement	-20°C à +40°C
Résistance au feu	650°C

## Choix de votre référence

Dim	IP	Gradation	Temp couleur	Flux	Puissance	Rendement	Code	
Longueur 600mm	IP20/40	On/Off	3000 / 4000K	1500 / 2400 lm	10,8 / 17W	140 lm/W	768390	
Longueur 1200mm		On/Off	3000 / 4000K	2500 / 4100 lm	18 / 29,5W	140 lm/W	768406	
							4000K	4100 lm
		6400 lm	49W	948808				
Longueur 1500mm		Signify Interact	3000 / 4000K	3500 / 5200 lm	25 / 37W	140 lm/W	768369	
		On/Off	3000 / 4000K	3000 / 4000K	3500 / 5200 lm	25 / 37W	140 lm/W	768413
								4000K
		Signify Interact	3000 / 4000K	3000 / 4000K	8000 lm	59W	136 lm/W	948860
	4000K							57W
On/Off	3000 / 4000K	6400 / 10 000lm	45,5 / 71W	140 lm/W	768420			

# Ledinaire Reglette BN021C



5 ans



IP20



IK02



PHILIPS



Mise en ligne simple et rapide



Accessoires inclus : câble d'alimentation, câble de raccordement, étriers de fixation

## Schémas techniques

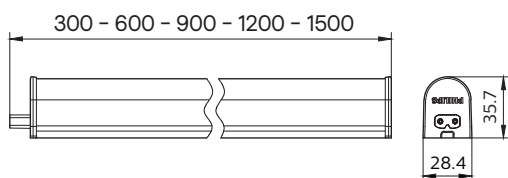

Dimensions en mm

## Caractéristiques techniques

IRC	80
Chromaticité initiale	SDCM<5
Classe électrique	II
Risque photobiologique	RG0
Temp. de fonctionnement	-20°C à +40 °C
Résistance au feu	650°C

## Choix de votre référence

Dim	IP	Gradation	Temp couleur	Flux	Puissance	Rendement	Code
Longueur 300mm	IP20	On/Off	3000K	480 lm	5 W	96 lm/W	527850
			4000K	540 lm		108 lm/W	527843
Longueur 600mm			3000K	960 lm	10 W	96 lm/W	527874
			4000K	1050 lm		105 lm/W	527867
Longueur 900mm			3000K	1450 lm	15 W	97 lm/W	527898
			4000K	1600 lm		107 lm/W	527881
Longueur 1200mm			3000K	1900 lm	20 W	95 lm/W	527911
			4000K	2100 lm		105 lm/W	527904
Longueur 1500mm			3000K	2400 lm	24 W	100 lm/W	527935
			4000K	2600 lm		108 lm/W	527928

# CoreLine Plafonnier gen4 SM136V



5 ans



IP20



IK03

**PHILIPS** **interact**

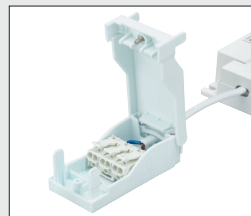

Connecteur rapide



Driver et connecteur facilement accessibles à l'arrière du produit

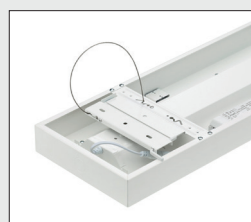

Accessoire de pose inclus pour installer facilement le produit en plafonnier



Réglage facile de la puissance via le commutateur intégré

## Schémas techniques

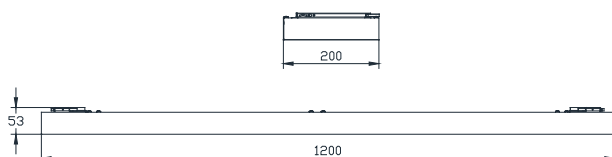

Dimensions en mm

## Caractéristiques techniques

IRC	80
Diffuseur	Microprismatique
Chromaticité initiale	SDCM<3
Classe électrique	II
Risque photobiologique	RG0
Temp. de fonctionnement	-10°C à +40°C
Résistance au feu	650°C
ENEC	Oui

## Choix de votre référence

Dim	UGR	Gradation	Temp couleur	Flux	Puissance	Rendement	Code	
Rectangulaire 1200x200mm	UGR19	On/Off	4000K	3600 / 4500/ 6000 lm	23 / 29 / 38,5 W	157 lm/W	764224	
			3000K	3400 / 4300/ 5700 lm		148 lm/W	764231	
		DALI-2	4000K	3600 / 4500/ 6000 lm		157 lm/W	764248	
			Signify Interact	3000K		4000 lm	27,5W	145 lm/W
	4300 lm	156 lm/W		764262				
	UGR22	On/Off	4000K	3600 / 4500/ 6000 lm	23 / 29 / 38,5 W	157 lm/W	764217	
Rectangulaire 1570x200mm	UGR19	On/Off	3000K	3400 / 4300/ 6500 lm	22,5 / 29 / 43,5 W	151 lm/W	764286	
			4000K	3600 / 4500/ 6800 lm		160 lm/W	764279	
		DALI-2	3000K	3400 / 4300/ 6500 lm		151 lm/W	764309	
			4000K	3600 / 4500/ 6800 lm		160 lm/W	764293	
		Signify Interact	3000K	4000 lm		27,5W	145 lm/W	764316
			4000K	4300 lm			156 lm/W	764323

# Ledinaire Plafonnier gen2 SM060C



5 ans



IP20



IK03



**PHILIPS**



Connecteur rapide

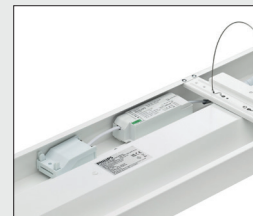

Vue arrière

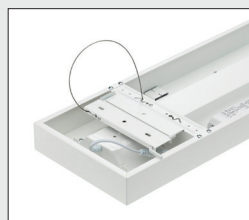

Accessoire de pose inclus pour installer facilement le produit en plafonnier

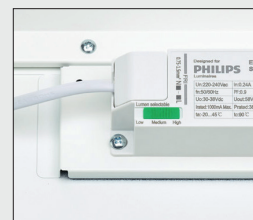

Réglage facile de la puissance via le commutateur intégré

## Schémas techniques

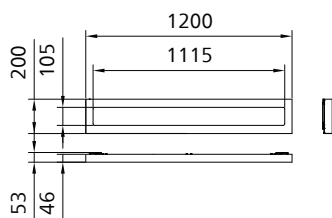

Dimensions en mm

## Caractéristiques techniques

IRC	80
Diffuseur	Microprismatique ou dépoli
Chromaticité initiale	SDCM<5
Classe électrique	I
Risque photobiologique	RG0
Temp. de fonctionnement	-10°C à +40°C
Résistance au feu	650°C

## Choix de votre référence

Dim	IP	UGR	Gradation	Temp couleur	Flux	Puissance	Rendement	Code
Rectangulaire 1200x200mm	IP20	UGR19	On/Off	4000K	3400 / 4000 lm	28 / 33 W	121 lm/W	764712
		UGR25						764705



# CoreLine Hublot WL140V



5 ans



IP65



IK10

**PHILIPS** **interact**

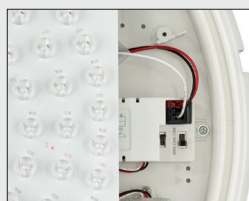

Réglage facile de la puissance et de la température de couleur via les commutateurs intégrés



Option : coupe flux pour les applications extérieurs

## Schémas techniques

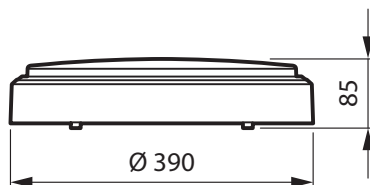

Dimensions en mm

## Caractéristiques techniques

IRC	80
Chromaticité initiale	SDCM<3
Classe électrique	II
Risque photobiologique	RG0
Temp. de fonctionnement	-20 à +40°C
Résistance au feu	650°C
ENEC	Oui

## Choix de votre référence

Dim	IP	Détection	Gradation	Temp couleur	Flux	Puissance	Rendement	Installation	Code
Ø 390 mm	IP65	Sans détecteur	On/Off	2700 / 3000 / 4000K	1400 / 2400 / 4000lm	11W / 18W / 29W	140lm/W	Intérieur en mural et plafonnier, extérieur en mural uniquement	307132
			DALI-2		4000 lm	29W			307163
			Signify Interact						307170
		Avec détecteur	On/Off, gestion individuelle	1400 / 2400 / 4000lm	12W/ 19W / 30W	135lm/W			307149
			On/Off, gestion par groupe						307156

# Ledinaire Hublot WL070V



5 ans



IP65



IK08

**PHILIPS**



## Schémas techniques

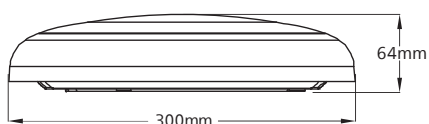

Dimensions en mm

## Caractéristiques techniques

IRC	80
Chromaticité initiale	SDCM<5
Classe électrique	II
Risque photobiologique	RGO
Temp. de fonctionnement	-20 à +40°C
Résistance au feu	850°C

## Choix de votre référence

Dim	IP	Detection	Gradation	Temp couleur	Flux	Puissance	Rendement	Installation	Code
Ø 300 mm	IP65	Sans détecteur	On/Off	3000 / 4000 / 5700K	1100 / 1700 lm	11 / 17 W	105 lm/W	Intérieur en mural et plafonnier, extérieur en mural uniquement	767461
		Avec détecteur							767478

# CoreLine Armature gen6 BY120P/BY121P/BY120X/BY121X

100 000h  
L70



5 ans



IP66



IK08

**PHILIPS** **interact**

196  
lm/W  
max



Versions compatibles avec le système Signify Interact et multicapteur présence/luminosité intégré



Crochet fournis dans le carton de chaque luminaire



Connecteur étanche IP68 déjà câblé à l'armature



En option :  
Lyre de fixation

## Schémas techniques

BY120P

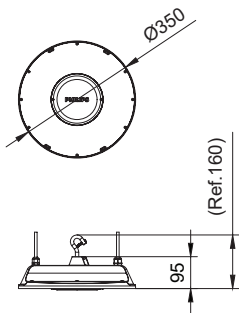

BY121P

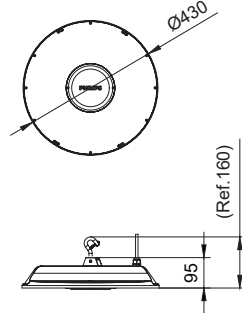

BY120X SIA

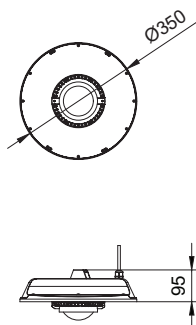

BY121X SIA

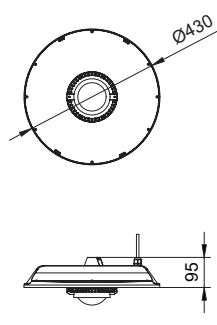

Dimensions en mm

## Caractéristiques techniques

IRC	80
Chromaticité initiale	SDCM<5
Classe électrique	I
Risque photobiologique	RG0
Temp. de fonctionnement	-40°C à +50°C
Résistance au feu	650°C
ENEC	Oui

## 2 optiques au choix :

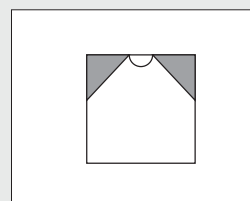

Optique extensive (WB)

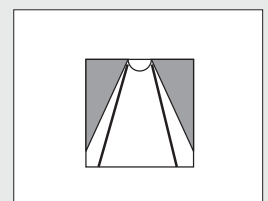

Optique intensive spéciale rack (NB)

## Choix de votre référence

Dimension	Temp couleur	Flux	Gradation	Faisceau	UGR	Puissance	Rendement	Code	
Petit Ø350 mm	4000K	10 000 lm	On/Off	Etroit 55°	UGR22	51 W	196 lm/W	306371	
				Large 90°	UGR25			306364	
			DALI-2	Etroit 55°	UGR22	55 W	182 lm/W	306517	
				Large 90°	UGR25			306500	
			Signify Interact avec capteur intégré	Etroit 55°	UGR22	55 W	182 lm/W	306630	
				Large 90°	UGR25			306623	
		20 000 lm	On/Off	Etroit 55°	UGR22	105 W	190 lm/W	306418	
				Large 90°	UGR25			306401	
			DALI-2	Etroit 55°	UGR22	110 W	182 lm/W	306555	
				Large 90°	UGR25			306548	
			Signify Interact avec capteur intégré	Etroit 55°	UGR22	110 W	182 lm/W	306678	
				Large 90°	UGR25			306661	
Moyen Ø430 mm	4000K	25 000 lm	On/Off	Etroit 55°	UGR22	130 W	192 lm/W	306432	
				Large 90°	UGR25			306425	
			DALI-2	Etroit 55°	UGR22	137 W	182 lm/W	306579	
				Large 90°	UGR25			306562	
		28 000 lm	DALI-2	Etroit 55°	UGR22	153 W	183 lm/W	306746	
				Large 90°	UGR25			306753	
			Signify Interact avec capteur intégré	Etroit 55°	UGR22	153 W	183 lm/W	306777	
				Large 90°	UGR25			306760	
		30 000 lm	On/Off	Etroit 55°	UGR22	150 W	194 lm/W	306456	
				Large 90°	UGR25			306449	
		Grand Ø480 mm	40 000 lm	DALI-2	Etroit 55°	UGR22	222 W	180 lm/W	306616
					Large 90°	UGR25			306609
Signify Interact avec capteur intégré	Etroit 55°			UGR22	222 W	180 lm/W	306739		
	Large 90°			UGR25			306722		

## Accessoires

Lyre de fixation pour CoreLine Armature gen6 (toutes versions)

Code

BY121Z G6 BR L300

324139



# Ledinaire Armature BY030P

50 000h  
L80



5 ans



IP65



IK03

**PHILIPS**

155  
lm/W  
max

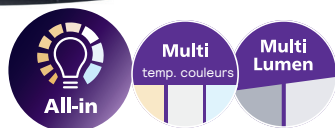

Armature Ledinaire All in



Armature Ledinaire gen3

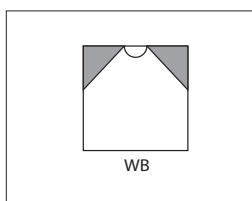

Sans accessoire  
Réflecteur :  
Optique extensive (WB)

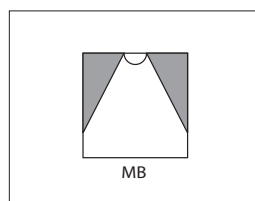

Avec accessoire  
Réflecteur :  
Flux intensifié



Crochet fournit dans le carton de chaque luminaire



Option : réflecteur vissable (compatible uniquement avec l'armature Ledinaire All-in)



Réglage facile de la puissance et de la température de couleur via les commutateurs intégrés



Option : détecteur de mouvement (compatible uniquement avec l'armature Ledinaire All-in)



Partie supérieure

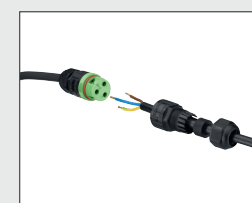

Connecteur étanche IP68 déjà câblé à l'armature

## Caractéristiques techniques

IRC	80
Classe électrique	Classe I
Résistance au feu	650°C
Temp. de fonctionnement	-30°C à +50°C

## Schémas techniques

Ledinaire Armature All in

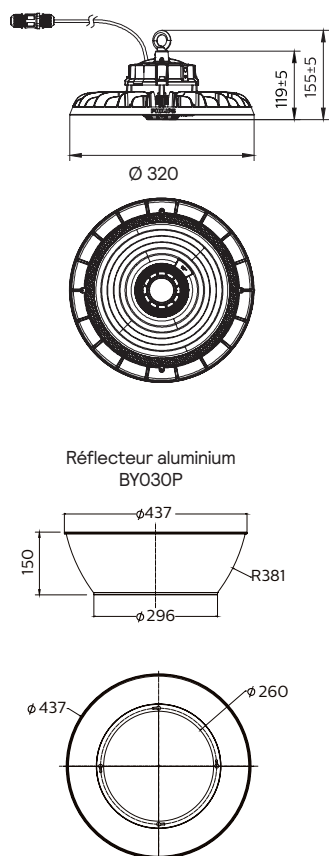

Ledinaire Armature gen 3

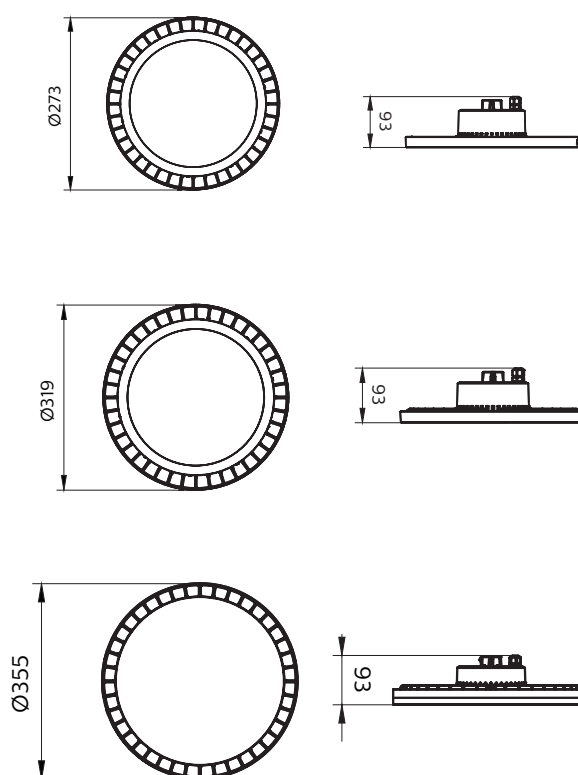

Dimensions en mm

## Choix de votre référence

Dimension	Poids	Gradation	Temp couleur	Faisceau	Flux	Puissance	Rendement	Code
320 mm	2,46 kg	On/Off	4000 / 5000 / 6500 K	Large 90°	15 000 / 22 000 / 28 000 lm	100 / 150 / 195 W	145 / 155 lm/W	758971
273 mm	1,41 kg	On/Off	4000K	Large 90°	10 500 lm	70 W	150 lm/W	761353
319 mm	2,05 kg				20 000 lm	133 W		761360
355 mm	2,7 kg				28 000 lm	185 W		761377



# CoreLine Tempo BVP111/BVP125/BVP130

100 000h  
L85



5 ans



IP66



IK08

**PHILIPS**  **interact**

147  
lm/W  
max



## Caractéristiques techniques

IRC	70
Temp. de fonctionnement	-40°C à +45°C
Classe électrique	I
Certifications	ENEC, ENEC +, Nuisance lumineuse

## Schémas techniques

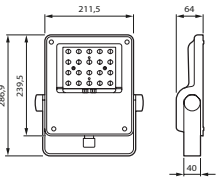

BVP111 (Small)

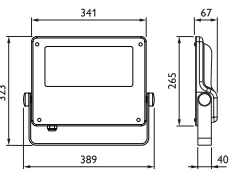

BVP125 (Medium)

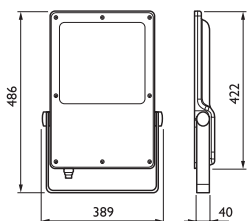

BVP130 (Large)



## Choix de votre référence

Dim	Poids	Flux système	Puissance	Rendement	Temp couleur	Faisceau	Code
Small	2,57 Kg	4263 lm	31 W	137 lm/W	3000K	Asymétrique	556812
		4263 lm		137 lm/W		Symétrique	557352
		4437 lm	31 W	143 lm/W	4000K	Asymétrique	556799
		4437 lm		143 lm/W		Symétrique	556805
		6278 lm	43 W	146 lm/W	Asymétrique	556829	
Medium	5 kg	8000 lm	59 W	137 lm/W	3000K	Symétrique	905187
			57 W	144 lm/W	4000K	Asymétrique	455880
		12000 lm	88 W	136 lm/W	3000K	Symétrique	905156
			90 W	134 lm/W	4000K	Asymétrique	455873
		16000 lm	117 W	137 lm/W		Symétrique	455897
					Asymétrique	558960	
		Symétrique	558977				
		Large	7,5 kg	16000 lm	114 W	142 lm/W	3000K
Symétrique	905255						
21000 lm	153 W			137 lm/W	4000K	Asymétrique	905163
	141 W			147 lm/W		Symétrique	905248
26000 lm	191 W			136 lm/W	3000K	Asymétrique	096403
	182 W			143 lm/W	4000K	Symétrique	096434
30000 lm	209 W			143 lm/W		Asymétrique	905170
	209 W			143 lm/W	Symétrique	905231	
Asymétrique	096397						
Symétrique	096427						
Asymétrique	558984						
Symétrique	558991						

# Ledinaire Floodlight BVP167/BVP169



5 ans



IP65



IK07



**PHILIPS**



## Caractéristiques techniques

IRC	80
Chromaticité initiale	SDCM<5
Classe électrique	I
Temp. de fonctionnement	-25°C à +40°C

Ledinaire Floodlight All-in Mini



10-20-30-50-70W Symétrique



65W Asymétrique



10-20-30-50W Symétrique avec détecteur de mouvement



Ledinaire FloodLight All-in Maxi



100-150-200W Symétrique



90-135-180W Asymétrique



## Schémas techniques

Ledinaire Floodlight All-in Standard

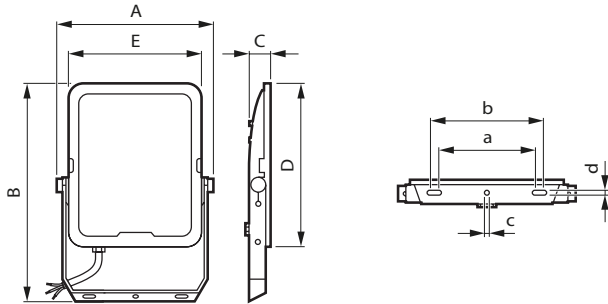

Dimensions en mm

Ledinaire Floodlight All-in Avec détecteur (MDU)

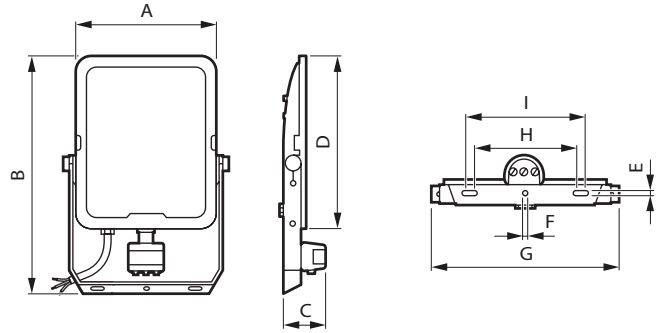

Dimensions en mm

SWB

mm	10W	20W	30W	50W	70W	100W	150W	200W
A	85	97	133	173	203	220	282	336
B	130	149	182	232	286	304	401	474
C	31	31	29	30	33	36	37	41
D	90	109	145	185	215	244	320	380
E	70	82	117	150	175	185	242	296
a	41	50	70	90	110	110	136	210
b	51	60	85	110	130	130	166	240
c	4.2	4.2	4.5	6.5	6.5	8.5	10.5	10.5
d	4.2	4.2	4.5	6.5	6.5	8.5	10.5	10.5

AWB

mm	65W	90W	135	180W
A	203	220	282	336
B	286	304	401	474
C	33	36	37	41
D	215	24	320	380
E	175	185	242	296
a	110	110	136	210
b	130	130	166	240
c	6.5	8.5	10.5	10.5
d	6.5	8.5	10.5	10.5

SWB

mm	10W	20W	30W	50W	70W
A	70	82	117	150	175
B	174	191	220	263	295
C	58	58	58	58	60
D	90	109	145	185	215
E	4.2	4.2	4.5	6.5	6.5
F	4.2	4.2	4.5	6.5	6.5
G	85	97	133	173	203
H	41	50	70	90	110
I	51	60	85	110	130



Réglage facile de la température de couleur via le commutateur intégré

## Choix de votre référence

Detection	Faisceau	Temp couleur	Flux	Puissance	Rendement	Dim	Poids	Code
Sans détecteur	Symétrique	3000 / 4000 / 6500K	1200 lm	10 W	120 lm/W	85 mm	0,26 Kg	736016
			2400 lm	20 W		97 mm	0,30 kg	736023
			3600 lm	30 W		133 mm	0,56 Kg	736030
			6000 lm	50 W		173 mm	0,82 Kg	736047
			8400 lm	70 W		203 mm	1,37Kg	736054
			12 000 lm	100 W		220 mm	1,91 kg	736061
	18 000 lm		150 W	282 mm	3,01 kg	736078		
	24 000 lm		200 W	336 mm	4,24 kg	736085		
	7350 lm		65 W	115 lm/W	203 mm	1,43 kg	736115	
	10 500 lm		90 W		220 mm	2,08 kg	736122	
	15 750 lm		135 W		282 mm	3,29kg	736139	
	21 000 lm		180 W		336 mm	4,55 kg	736146	
1200 lm	10 W	120 lm/W	85 mm		0,29 kg	736153		
2400 lm	20 W		97 mm		0,33 kg	736160		
3600 lm	30 W		133 mm	0,60 kg	736177			
6000 lm	50 W		173 mm	0,86 kg	736184			

# Luminaire Extérieurs LumiStreet/TownGuide

## LumiStreet gen2

141  
lm/W  
max

100 000h  
L94

5 ans



PHILIPS

Dim	Couleur	Poids	Gradation	Temp couleur	Faisceau	Installation	Flux	Puis- sance	Rendement	Code
Mini - 621 mm	Peinture standard	5,1 kg	DALI-2	3000K	DM 50 (voies résidentielles / Abords de bâtiments)	sur crosse ou Top de mât 48 / 60 mm	6880 lm	54 W	127 lm/W	169593
							10200 lm	81 W	126 lm/W	169562
Micro - 521 mm	Peinture bord de mer	4 kg					4524 lm	32,5 W	139 lm/W	181403
Mini - 621 mm		5,1 kg					8600 lm	61 W	141 lm/W	181427

## TownGuide

106  
lm/W  
max

100 000h  
L93

5 ans



signify

Dim	Couleur	Poids	Gradation	Temp couleur	Faisceau	Installation	Flux	Puissance	Rendement	Code
571 mm	Peinture standard	6,48 kg	On/Off	3000K	DW Large (voies résidentielles)	Top de mât 60/62 mm	5250 lm	49,5W	106 lm/W	181908
		6,2 kg			Symétrique (Parking / Jardins)		3700 lm	36,5 W	101 lm/W	181830



# Les tubes T8

## Master Performance

PHILIPS



## Master Value

PHILIPS

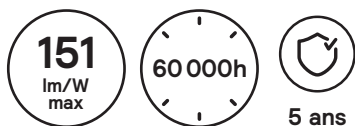

## CorePro

PHILIPS

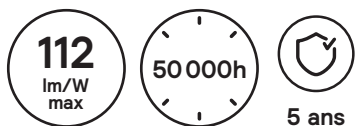

## LEDtube T8 EM/230V

①



②



③



①

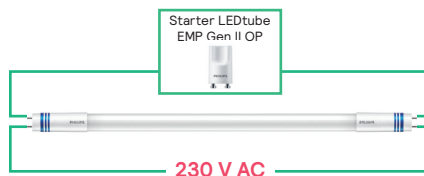

## Choix de votre référence

Dim	Puissance Equ.	Temp couleur	Compatibilité Ballast	Flux	Puissance	Gamme	Durée de vie	Code				
600mm	18W	3000K	Ferromagnétique ou 230V	1000lm	8W	Master Value	60 000h	646790				
						7,6W	Master Performance	75 000h	697474			
			Universel	850lm	8W	CorePro	100 000h	044150	782771			
		4000K	Ferromagnétique ou 230V	800 lm	1050lm	8W	CorePro	50 000h	325319			
							Master Value	60 000h	646813			
				Universel	900lm	8W	Master Performance	75 000h	697498			
			6500K	Ferromagnétique ou 230V	800 lm	1050lm	8W	CorePro	100 000h	044174		
								Master Value	60 000h	646837		
				Universel	900lm	8W	CorePro	50 000h	782795			
		900mm	30W	4000K	Ferromagnétique ou 230V	1575lm	12W	Master Performance	50 000h	782818		
		1200mm	36W	3000K	Ferromagnétique ou 230V	2000lm	14W	Master Value	60 000h	646851		
					Universel	1850lm	18W	CorePro	50 000h	801666		
4000K	Ferromagnétique ou 230V			2000 lm	2100lm	18W	CorePro	50 000h	469587			
						14W	Master Value	60 000h	646875			
				Universel	2100lm	11,3W	Master Performance	75 000h	592370			
	Ferromagnétique ou 230V			2500lm	11,7W	100 000h			388079			
	6500K			Ferromagnétique ou 230V	2000 lm	2100lm	18W	CorePro	50 000h	801680		
							14W			Master Value	60 000h	646899
6500K	Universel			2000lm	2400lm	18W	CorePro	50 000h	801703			
						15,5W			200005			
				Ferromagnétique ou 230V	2000 lm	18W	CorePro	50 000h	806111			
	1500mm			58W	3000K	Ferromagnétique ou 230V	2900lm	20,5W	Master Value	60 000h	646912	
						Universel	2500lm	23W	CorePro	50 000h	801727	
					4000K	Ferromagnétique ou 230V	2700 lm	3100lm	24W	CorePro	50 000h	469600
							25,9W		278660			
Universel							3100lm	20,5W	Master Value	60 000h	646936	
6500K						Ferromagnétique ou 230V	3100lm	3700lm	18,2W	Master Performance	75 000h	592431
									16,7W			100 000h
		Universel	2700lm			23W	CorePro	50 000h	801741			
6500K		Universel	3500lm		2700 lm	24W	CorePro	50 000h	806159			
									25,9W	278684		
			Ferromagnétique ou 230V		3100lm	20,5W	Master Value	60 000h	646950			
		6500K	Universel		2700lm	3500lm	23W	CorePro	50 000h	801765		
				200043								
	Ferromagnétique ou 230V		2700 lm	24W	CorePro	50 000h	806159					
	3500lm	25,9W	Master Value	60 000h	646950							
	3100lm	20,5W	CorePro	50 000h	801765							
	3500lm	23W	CorePro	50 000h	200067							

# Les tubes T5

Master

PHILIPS

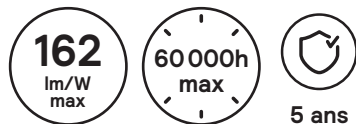

CorePro

PHILIPS



## Choix de votre référence

Dim	Puissance Equ.	Temp couleur	Compatibilité Ballast	Flux	Puissance	Gamme	Durée de vie	Code			
600mm	14W	3000K	Ballast électronique	1000lm	7,1W	CorePro	50 000h	295407			
					7W	Master	60 000h	309661			
		4000K		1050lm	7,1W	CorePro	50 000h	295421			
				1100lm	7W	Master	60 000h	309685			
				1050lm	7,1W	CorePro	50 000h	295445			
	6500K	1100lm	7W	Master	60 000h	309708					
		24W	3000K	Ballast électronique	1500lm	10,5W	Master	60 000h	163072		
				Direct 230V					275218		
		4000K	Ballast électronique	1600lm	163096						
			Direct 230V	1700lm	275317						
6500K	Ballast électronique	1600lm	163119								
	Direct 230V	1700lm	275232								
900mm	21W	3000K	Ballast électronique	1600lm	11,5W				Master	60 000h	163195
			Direct 230V								270626
		4000K	Ballast électronique	1700lm							163218
			Direct 230V								270640
		6500K	Ballast électronique	1700lm		163232					
			Direct 230V			270664					
	39W	3000K	Ballast électronique	2600lm		18,5W	Master	60 000h			163133
			Direct 230V								275256
		4000K	Ballast électronique	2800lm							163157
			Direct 230V								275270
		6500K	Ballast électronique	2800lm							163171
			Direct 230V								275294

## LEDtube T5 EM/230V



Dim	Puissance Equ.	Temp couleur	Compatibilité Ballast	Puissance	Flux	Gamme	Durée de vie	Code	
1200mm	28W	3000K	Ballast électronique	17,1W	2300lm	CorePro	50 000h	295469	
			Direct 230V	16,5W		Master	60 000h	743294 334311	
		4000K	Ballast électronique	17,1W	2500lm	CorePro	50 000h	295483	
			Direct 230V	16,5W		Master	60 000h	743317 334335	
		6500K	Ballast électronique	17,1W	2500lm	CorePro	50 000h	295506	
			Direct 230V	16,5W		Master	60 000h	743331 334359	
	54W	3000K	Ballast électronique	26,7W	3700lm	CorePro	50 000h	295582	
			Direct 230V	26W		Master	60 000h	749514 819210	
		4000K	Ballast électronique	26,7W	3900lm	CorePro	50 000h	295605	
			Direct 230V	26W		Master	60 000h	749538 819234	
		6500K	Ballast électronique	26,7W	3900lm	CorePro	50 000h	295629	
			Direct 230V	26W		Master	60 000h	749552 819258	
	1500mm	35W	3000K	Ballast électronique	20,5W	2800lm	CorePro	50 000h	295520
				Direct 230V	20W		Master	60 000h	743355 334373
			4000K	Ballast électronique	20,5W	3000lm	CorePro	50 000h	295544
				Direct 230V	20W		Master	60 000h	743379 334397
			6500K	Ballast électronique	20,5W	3000lm	CorePro	50 000h	295568
				Direct 230V	20W		Master	60 000h	743393 334410
49W		3000K	Ballast électronique	26,7W	3700lm	CorePro	50 000h	295643	
			Direct 230V	26W		Master	60 000h	749576 819296	
		4000K	Ballast électronique	26,7W	3900lm	CorePro	50 000h	295667	
			Direct 230V	26W		Master	60 000h	749590 819319	
		6500K	Ballast électronique	26,7W	3900lm	CorePro	50 000h	295681	
			Direct 230V	26W		Master	60 000h	749613 819333	
80W		3000K	Ballast électronique	36W	5200lm	Master	60 000h	419056	
		4000K			5600lm			419070	
		6500K			5600lm			419094	

# Bulb

## Master UE

**210**  
lm/W  
max

**50 000h**  
max

IRC 80

**PHILIPS**



## Master Value

**136**  
lm/W  
max

**25 000h**

IRC 90

**PHILIPS**



## CorePro

**107**  
lm/W  
max

**15 000h**

IRC 80

**PHILIPS**



## CorePro LEDbulb E27 All In

**100**  
lm/W  
max

**15 000h**

**PHILIPS**



**PHILIPS**

6500K  
5000K  
4000K  
3000K  
2700K



Culot	Puissance Equ.	Temp couleur	Faisceau	Gradable	Puissance	Flux	Gamme	Matériaux	Durée de vie	Code
E27	60W	2700K 3000K 4000K 5000K 6500K	36°	oui	8W	900 lm	CorePro	Plastique dépoli	15000h	353336

# Bulb

Choix de votre référence **PHILIPS**

Verre Clair



Verre dépoli



Plastique dépoli



Edison



Globe

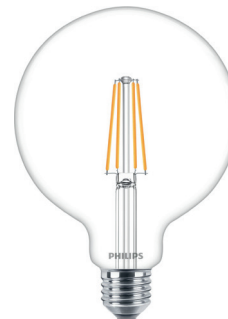

Culot	Puissance Equ.	Temp couleur	Gradable	Puissance	Flux	Gamme	Matériaux	Durée de vie	Code		
B22	40W	3000K	non	5W	470 lm	CorePro	Plastique dépoli	15000h	329720		
	60W			7,5W	806 lm				329744		
	75W			10,5W	1055 lm				329768		
	100W			13W	1521 lm				329782		
E27	40W	2700K	non	4,3W	470 lm	CorePro	Verre Clair	15000h	347168		
			oui	4W		Master	Verre dépoli	25000h	310919		
		3000K	non	5W	470 lm	CorePro	Plastique dépoli	15000h	329560		
			oui	3,4W	470 lm	Master	Verre dépoli		449893		
		4000K	non	4,9W	470 lm	CorePro	Plastique dépoli	15000h	329584		
			oui	3,4W		Master	Verre dépoli		449893		
		E27	60W	2700K	non	8W	806 lm	CorePro	Plastique dépoli	15000h	420670
					oui	7W		Master	Verre Clair		380035
oui	5,9W				Master	Verre dépoli		25000h	311053		
2700K 3000K 4000K 5000K 6500K				oui	8W	900 lm	CorePro	Plastique dépoli	15000h	353336	
3000K	non			7,5W	806 lm	CorePro	Plastique dépoli	50000h	329607		
	oui			4W	840 lm	Master UE	Verre Clair		254121		
	oui			4W	840 lm	Master UE	Verre dépoli		254169		
	oui			4W	840 lm	Master UE	Verre dépoli		248687		
4000K	non			7,5W	806 lm	CorePro	Plastique dépoli	50000h	329621		
	oui			4W	840 lm	Master UE	Verre Clair		188532		
	oui			5,9W	806 lm	Master	Verre dépoli		284289		
E27	75W			2700K	non	10W	1055 lm	CorePro	Plastique dépoli	15000h	420694
		oui	8,5W		Master	Verre Clair		347120			
		oui	7,8W		Master	Verre dépoli		347908			
		3000K	non	10,5W	1055 lm	CorePro	Plastique dépoli	15000h	329645		
			oui	5,2W	1095 lm	Master UE	Verre Clair	50000h	254206		
		4000K	non	10W	1055 lm	CorePro	Plastique dépoli	15000h	329669		
			oui	5,2W		Master UE	Verre Clair	50000h	188693		
			oui	7,8W		Master	Verre dépoli	15000h	449930		
E27	100W	2700K	non	10,5W	1521 lm	CorePro	Verre Clair	15000h	347144		
			oui	11,2W		Master	Verre dépoli		347946		
		3000K	non	13W	1521 lm	CorePro	Plastique dépoli	15000h	329683		
			oui	7,3W	1535 lm	Master UE	Verre Clair	50000h	254282		
		4000K	non	12,5W	1521 lm	CorePro	Plastique dépoli	15000h	329706		
			oui	7,3W	1535 lm	Master UE	Verre Clair	50000h	188853		
oui	7,3W	1535 lm	Master UE	Verre dépoli	50000h	188891					
E27	120W	2700K 4000K	non	13W	2000 lm	CorePro	Verre Clair	15000h	346499		
E27	150W	2700K 4000K	non	17W 17,5W	2452 lm	CorePro	Verre Clair	15000h	347441		
E27	200W	2700K 4000K	non	23W	3452 lm	CorePro	Verre dépoli	15000h	346673		
E27 EDISON	60W	2700K	oui	5,9W	806 lm	Master	Verre Clair	15000h	347960		
E27 GLOBE	60W	2700K	oui	5,9W	806 lm	Master	Verre dépoli	15000h	324817		
							Verre Clair	15000h	347984		

# PLC LED



## Choix de votre référence

Culot	Puissance Equ.	Temp couleur	Faisceau	Puissance	Flux	Gamme	Durée de vie	Code
G24D-1	13W	3000K	120°	5,9W	600lm	CorePro	30 000h	287501
		4000K			660lm			287525
		3000K 4000K 6500K	360°		850lm			035011
G24D-2	18W	3000K	120°	6,9W	700lm	CorePro	30 000h	287549
		4000K			770lm			287563
		3000K 4000K 6500K	360°		980lm			035035
G24D-3	26W	3000K	120°	8,9W	990lm	CorePro	30 000h	287587
		4000K			1100lm			287600
		3000K 4000K 6500K	360°		1300lm			035059
G24q-1	13W	3000K	120°	5,5W	600lm	CorePro	30 000h	290419
		4000K			660lm			290433
G24q-2	18W	3000K	120°	6,5W	700lm	CorePro	30 000h	290457
		4000K			770lm			290471
G24q-3	26W	3000K	120°	9W	990lm	CorePro	30 000h	290495
		4000K			1100lm			290518

# GU10

## CorePro Spot GU10 All

**PHILIPS**

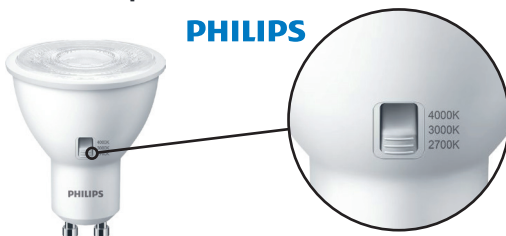

Puissance Equ.	Temp couleur	Faisceau	Gradable	Puissance	Flux	Gamme	Durée de vie	Code
50W	2700K 3000K 4000K	36°	oui	4,8	345lm	CorePro	15000h	369696

# GU10

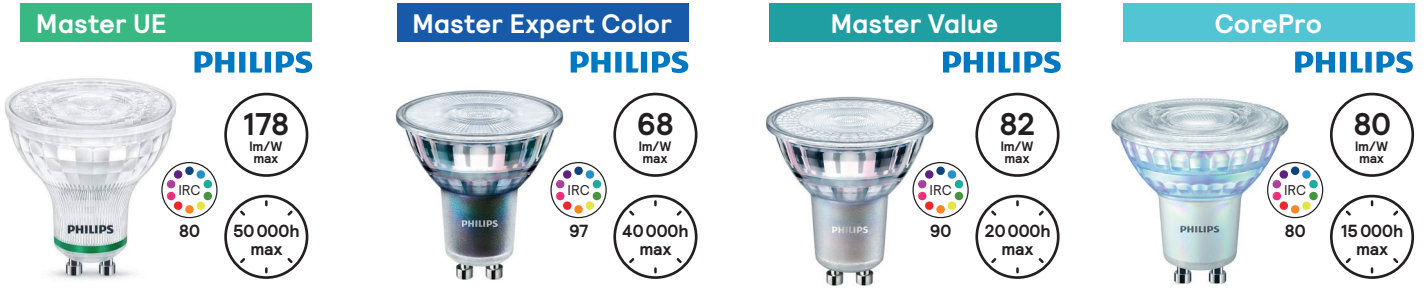

## Choix de votre référence

Puissance Equ.	Temp couleur	Faisceau	Gradable	Puissance	Flux	Gamme	Durée de vie	Code		
35W	2700K	36°	oui	3,7W	270lm	Master Value	25000h	308114		
				2,8W				399129		
				3,9W	265lm	Master ExpertColor	40000h	707555		
	3000K	36°	non	3,5W	265lm	CorePro	15000h	728338		
				2,30lm	721353					
				3,7W	270lm	Master Value	25000h	707753		
	4000K	36°	oui	2,8W	270lm	Master Value	25000h	399280		
				3,9W				280lm	Master ExpertColor	40000h
				3,5W	275lm	CorePro	15000h	728352		
			240lm	730225						
			non	3,7W	285lm	Master Value	25000h	707777		
				2,8W				399303		
3,9W	300lm	Master ExpertColor		40000h	707593					
50W	2700K	25°	oui	5,5W	355lm	Master ExpertColor	40000h	707616		
		36°		4,8W		Master Value	25000h	308138		
35W	2700K	36°	oui	3,7W	355lm	Master Value	25000h	399204		
50W	2700K	36°	oui	5,5W	355lm	Master ExpertColor	40000h	707678		
				4,8W				707913		
				3,7W	355lm	Master Value	25000h	399341		
	2700K 3000K 4000K	36°	oui	4,8W	345lm	CorePro	15000h	369696		
				5,5W	375lm	Master ExpertColor	40000h	707630		
				4,6W	370lm	CorePro	15000h	728376		
	4,7W	345lm	CorePro (Pack de 6)	420632						
	3000K	36°	non	2,1W	375lm	Master UE	50000h	174344		
				4W	345lm	CorePro	15000h	358836		
				4,9W	365lm	Master Value	25000h	707876		
			3,7W	399440						
			oui	5,5W	375lm	Master ExpertColor	40000h	707692		
				4,9W	365lm	Master Value	25000h	707937		
				3,7W				399365		
			4000K	25°	oui	5,5W	400lm	Master ExpertColor	40000h	707654
						non	4,6W	390lm	CorePro	15000h
	2,1W	375lm					Master UE	50000h	174368	
	36°	non		4W	350lm	CorePro	15000h	358850		
4,9W				380lm	Master Value	25000h	707890			
3,7W		399464								
oui		5,5W		400lm	Master ExpertColor	40000h	707715			
60°	oui	4,9W		380lm	Master Value	25000h	707951			
		3,7W					399389			
		3,7W		380lm	Master Value	25000h	038234			
65W	3000K	36°	non	4,9W	460lm	CorePro	15000h	308718		
	4000K			485lm	308619					
80W	3000K	36°	oui	6,2W	575lm	Master Value	25000h	705251		
				5,5W				038272		
	4000K	36°	oui	6,2W	575lm	Master Value	25000h	705237		
				5,5W				038234		

### Centre support professionnel

0 825 800 380 (0,15€/min)

du lundi au vendredi entre 9h et 18h :

- Support technique produit ou application
- Garantie
- Réclamation technique produit

Contactez-nous :

### Par téléphone : 0 825 090 061

(0,15€/min) du lundi au vendredi,

de 8h30 à 12h00 et de 14h00 à 16h00

### Par email :

Pour vos commandes :

[commande.pro@signify.com](mailto:commande.pro@signify.com)

Pour vos offres de prix :

[offre.pro@signify.com](mailto:offre.pro@signify.com)

Pour toute autre demande :

[www.philips.fr/contact-eclairage](http://www.philips.fr/contact-eclairage)

Contactez-nous :

### Par téléphone : 0 825 090 061

(0,15€/min) du lundi au vendredi,

de 8h30 à 12h00 et de 14h00 à 16h00

### Par email :

Pour vos commandes :

[commande.pro@signify.com](mailto:commande.pro@signify.com)

Pour vos offres de prix :

[offre.pro@signify.com](mailto:offre.pro@signify.com)

Pour toute autre demande :

[www.philips.fr/contact-eclairage](http://www.philips.fr/contact-eclairage)

