



MultiOne

by **Signify**

User manual

MultiOne Engineering

Configuration tooling

MultiOne Engineering v3.20



User Manual

1 Introduction

Today's customer demands more flexibility and customization possibilities than "physical configurations" can offer. With configurable devices (drivers or sensors) with built-in controls or separate controllers you can configure the luminaire's behavior. You can control output levels, or even pre-configure dynamic dimming on the client's request; either directly in the factory or during installation on location. All you need is ONE intuitive tool that when plugged into a device can calibrate ALL the different functions required by any lighting solution.

Creating the perfect lighting solution has been made very easy with MultiOne.

With MultiOne, you can configure all features that are supported by a device. A feature typically belongs to one or two product groups (LED Indoor/Outdoor, HID or FLUO), but this does not mean that every device from a product group does support all features.

MultiOne is supported by Windows 7 SP1, 8, 8.1 and 10 operating systems. It works only in combination with the LCN8600 MultiOne interface USB2DALI, with LCN8650 MultiOne interface USB2ZigBee, LCN9610, LCN9620 or LCN9630 MultiOne interface SimpleSet.

2 Table of contents

1	Introduction.....	2
3	System requirements	9
4	Downloading and installing MultiOne and the documentation package	10
5	Attention points.....	11
5.1	General.....	11
5.2	DALI.....	11
5.3	SimpleSet interface	11
6	The MultiOne interfaces.....	12
6.1	DALI.....	12
6.2	ZigBee	13
6.3	SimpleSet	13
7	Starting MultiOne.....	14
7.1	Activating MultiOne	14
7.2	Application mode selector.....	17
8	Selecting the interface.....	18
8.1	Interface Auto detection	18
8.2	Interface Manual selection	18
8.2.1	Art-Net.....	19
9	Working with the LCN8600 MultiOne interface USB2DALI.....	21
9.1	The main application window	21
9.2	Managing the DALI network.....	21
9.2.1	Identifying devices	21
9.2.2	Selecting devices for communication	24
9.2.3	Managing user-defined groups	25
9.2.4	Managing groups.....	26
10	Working with the LCN8650 MultiOne interface USB2ZigBee	30
10.1	The main application window	30
10.2	Connecting to a ZigBee network	30

10.2.1	Identifying devices	30
10.2.2	Selecting devices for communication	31
10.3	Advanced commissioning.....	31
10.3.1	Identifying devices	31
10.3.2	Managing networks.....	31
10.3.3	Managing zones	32
11	Working with the MultiOne SimpleSet interface(s).....	34
11.1	The main application window	34
11.2	Scanning a SimpleSet device.....	34
11.2.1	Identifying devices	34
11.2.2	Auto read.....	35
11.3	Selecting devices for communication	35
11.4	Starting communication.....	35
12	Working with MultiOne.....	36
12.1	Viewing device properties	36
12.2	Communicating with a device.....	36
12.3	Configuring device features.....	37
12.3.1	0-10V / 1-10V (SR bridge).....	41
12.3.2	0-10V / 1-10V (LED driver)	42
12.3.3	ActiLume General	43
12.3.4	ActiLume Mode.....	44
12.3.5	ActiLume Scene.....	46
12.3.6	Active Cooling.....	46
12.3.7	Adjustable Light Output.....	47
12.3.8	Adjustable Output Current.....	48
12.3.9	Adjustable Output Current Multi-Channel.....	48
12.3.10	Adjustable Startup Time	49
12.3.11	AmpDim.....	49
12.3.12	Auxiliary Power Supply Voltage	50
12.3.13	Coded Light On and Off.....	50

12.3.14	Coded Mains	50
12.3.15	Coded Mains Standalone Receiver	52
12.3.16	Constant Light Output.....	52
12.3.17	Constant Light Output Multi-Channel.....	55
12.3.18	Correlated Color Temperature Dual Channel.....	56
12.3.19	Corridor Mode.....	57
12.3.20	DALI 102	58
12.3.21	DALI 202	59
12.3.22	DALI Power Supply.....	60
12.3.23	Daylight override / Daylight switching	60
12.3.24	DC Emergency	61
12.3.25	Device Info	61
12.3.26	DiiA specification DALI Part 253 - Luminaire Maintenance	62
12.3.27	Dimming Interface	62
12.3.28	Driver addressing	64
12.3.29	Driver Temperature Limit.....	64
12.3.30	Driver Temperature Limit for Lock.....	65
12.3.31	Dwell Time	66
12.3.32	Dynadimmer.....	66
12.3.33	End Of Life indication.....	68
12.3.34	FCC.....	69
12.3.35	FccRed	70
12.3.36	FlexTune.....	71
12.3.37	Field Task Tuning.....	72
12.3.38	Field Task Tuning / Occupancy Sensing / Daylight Harvesting	73
12.3.39	Lamp Burn-in	74
12.3.40	Lamp Selection	74
12.3.41	Light Source Operating Hours.....	75
12.3.42	LineSwitch	75
12.3.43	Load Fault Indicator Thresholds.....	77

12.3.44	Logical Signal Input	78
12.3.45	Luminaire (Fixture) Information.....	79
12.3.46	Luminaire Production Test	80
12.3.47	LumiStep.....	81
12.3.48	Min Dim Level.....	82
12.3.49	Motor Control.....	83
12.3.50	Module Temperature Protection	84
12.3.51	NTC on LEDset.....	85
12.3.52	Occupancy Sensing / Daylight Harvesting	86
12.3.53	Occupancy sharing / Group light behavior.....	87
12.3.54	OEM Write Protection.....	87
12.3.55	Push Button Unit LCU2070.....	88
12.3.56	Push Button Unit LCU2071.....	89
12.3.57	Quick Lamp Start	89
12.3.58	Relay Switched Output.....	90
12.3.59	Self Contained Emergency	90
12.3.60	SR Power Supply.....	91
12.3.61	Step Dimming.....	92
12.3.62	Touch and Dim.....	92
12.3.63	Tx Power	93
12.4	Using the features summary.....	94
12.5	Saving and opening a feature configuration file.....	94
12.6	Configuring a single device.....	97
12.7	Configuring multiple DALI devices (simultaneously)	97
12.8	Configuring multiple DALI devices (consecutively)	98
12.8.1	MultiOne.....	98
12.9	Configuring multiple ZigBee devices.....	98
12.10	Offline feature configuration preparation	99
12.11	Sending DALI commands.....	100
12.12	Traceability	102

12.13	Working with DALI command scripts.....	102
12.14	Querying devices	105
12.15	Accessing Diagnostics.....	106
12.15.1	Diagnostics	106
12.15.2	Set Lamp On Time.....	116
12.16	Accessing Energy Meter	117
12.16.1	Energy Meter.....	118
12.16.2	DiiA specification DALI Part 252 - Energy reporting.....	118
12.17	Accessing Installer	119
12.17.1	Coded Light Randomize	119
12.18	Working with the DALI Sniffer.....	120
12.18.1	Sniffing with multiple interfaces	121
12.19	Art-Net export functionality.....	121
12.20	DALI Firmware update	122
12.21	The logging window	125
12.22	Setting preferences.....	125
12.22.1	General preferences.....	126
12.22.2	DALI.....	128
12.22.3	Updates.....	129
12.22.4	Proxy	130
12.23	Manually selecting the USB2DALI interface	130
12.24	Enabling/Disabling the power supply of the USB2DALI interface.....	131
12.25	Supported features	131
12.26	Device-specific technical descriptions.....	134
12.27	Error handling	134
12.27.1	Reporting and correction of errors/warnings when reading from a.... feature configuration file	134
12.27.2	Reporting of errors when reading from a device.....	134
12.27.3	Reporting of errors when entering incorrect values in a feature	134
12.28	Troubleshooting.....	134

13	Keyboard shortcuts.....	136
14	Software Update.....	137
15	Copyright.....	139
16	Disclaimer.....	140
17	Limitations of damages.....	141
18	List of tables	142
19	Index	143

3 System requirements

The minimum system requirements for using MultiOne are:

- PC or laptop with Microsoft Windows 7 SP1, 8, 8.1 or 10
- USB 2.0 ports:
 - o Two free USB 2.0 ports for use with USB2DALI interface
 - o One free USB 2.0 port for use with USB2ZigBee interface
 - o One free USB 2.0 port for use with SimpleSet interface
- Ethernet port:
 - o One free Ethernet port for use with Art-Net protocol
- At least 45 MB of free disk space
- Microsoft .NET Framework 4.6.1 ([download here for offline installation](#))

4 Downloading and installing MultiOne and the documentation package

A zip-file can be downloaded from <https://www.signify.com/multioneconfigurator>. This zip-file contains the following files:

- MultiOne.exe (executable/installer)
- MultiOne Workflow.exe (executable/installer)
- GettingStarted.pdf (document)
- UserManual.pdf (document)
- RELEASE_NOTES.txt (document)

The MultiOne installation file is the installer for the full version of MultiOne. This document applies to this version of the software.

The MultiOne Workflow installation file is the version of MultiOne which is meant to be used in a production environment.

Note! Make sure a User Software Key is present before installing. If you wish to install without a User Software Key, installation is possible, but you cannot work with MultiOne.

To install the software, launch the installer for the desired version and follow the instructions on your screen.

The installation wizard will guide you through the process of installing the software and will ask you where the software needs to be installed. At the end, it will give you the option to immediately start MultiOne.

5 Attention points

5.1 General

Before starting MultiOne, make sure that the correct interface (USB2DALI, USB2ZigBee or SimpleSet) has been connected to your computer.

When upgrading the Windows Operating System, make sure the connection settings are correct when using MultiOne again.

When starting multiple instances of MultiOne for parallel configuring, make sure every instance of MultiOne uses another interface. The unique id of an interface is shown in the Connection Settings window where the interface port is selected. Also, for the currently selected interface the unique id can be found in the About box and in the tooltip of the connection status indicator in the status bar at the bottom-right part of MultiOne.

5.2 DALI

Lighting applications with DALI devices can be seriously affected by the presence/absence of the DALI short address. Make sure the DALI short address is as you expect, after finishing working with MultiOne.

5.3 SimpleSet interface

For SimpleSet there are three interfaces which can be used for communication (see §6.3): the LCN9610, LCN9620 or LCN9630 MultiOne interface SimpleSet.

6 The MultiOne interfaces

6.1 DALI

The LCN8600 MultiOne interface USB2DALI (USB2DALI interface) is the interface between the PC and the DALI devices. It has a mini-USB input connector and two parallel DALI output connectors. The USB2DALI interface status is indicated by three LED's located near the mini-USB connector.

The USB2DALI interface is supplied with a USB cable that can supply the DALI network with up to 220mA. It is advised to only use the supplied cable, in order to assure correct functioning of the USB2DALI interface.

- Safety: Class II, double insulated
- DALI open circuit voltage (when power supply enabled): 15V
-

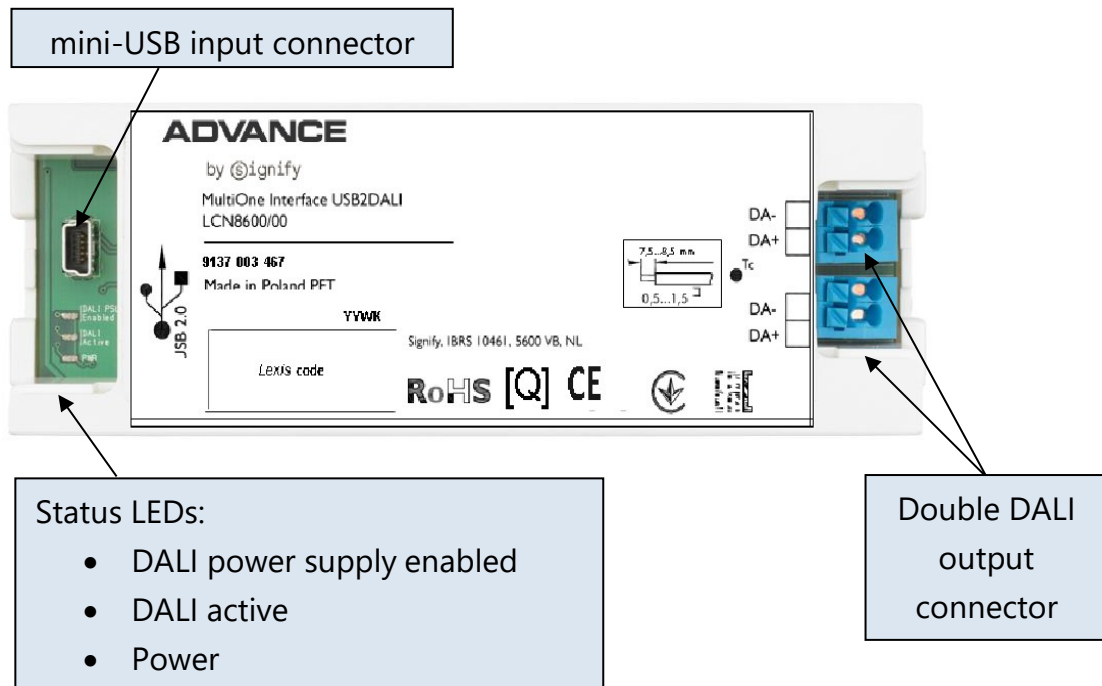

6.2 ZigBee

The LCN8650 MultiOne interface USB2ZigBee (USB2ZigBee interface) is an USB dongle which interfaces between the PC and the ZigBee devices.



6.3 SimpleSet

The LCN9610, LCN9620 and LCN9630 MultiOne interface SimpleSet are USB devices which interface between the PC and the SimpleSet devices:



LCN9610



LCN9620



LCN9630

7 Starting MultiOne

Before starting MultiOne, make sure that the correct interface (USB2DALI, USB2ZigBee or SimpleSet) has been connected to your computer.

7.1 Activating MultiOne

When starting MultiOne for the first time, the first window that appears is the **MultiOne user software key information**. Here you can activate your copy of MultiOne with your own user software key.

Note! MultiOne must be connected to the internet upon first usage in order to activate.

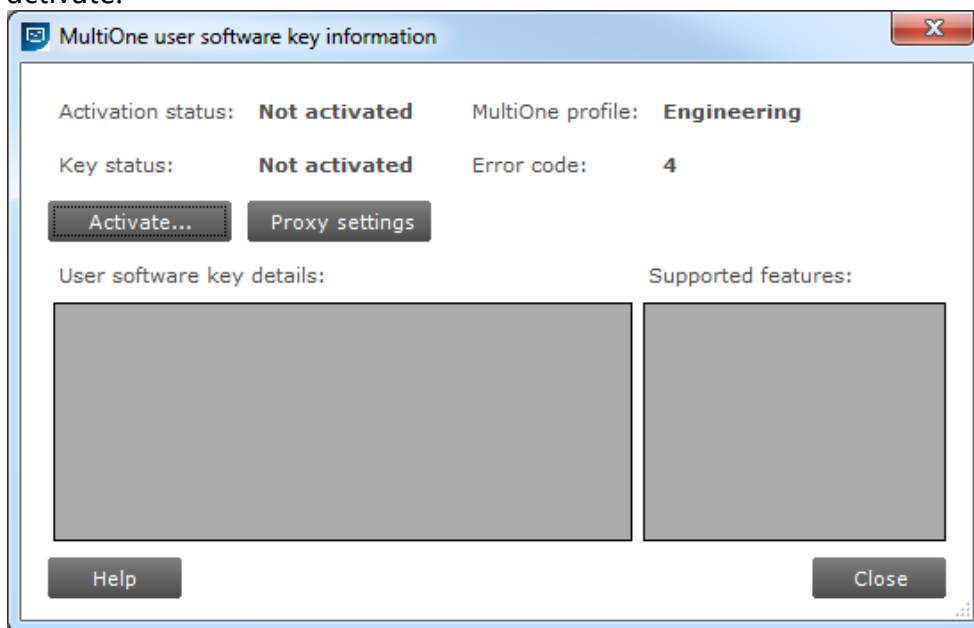

Use the **Activate...** button to continue activation.

Use the **Proxy settings** button to enter the proxy credentials if this is required for your infrastructure. An example of the information that can be entered can be found in chapter [Proxy](#).

Use the **Help** button to show the User Manual.

Select **Activate MultiOne online now** and follow the instructions.

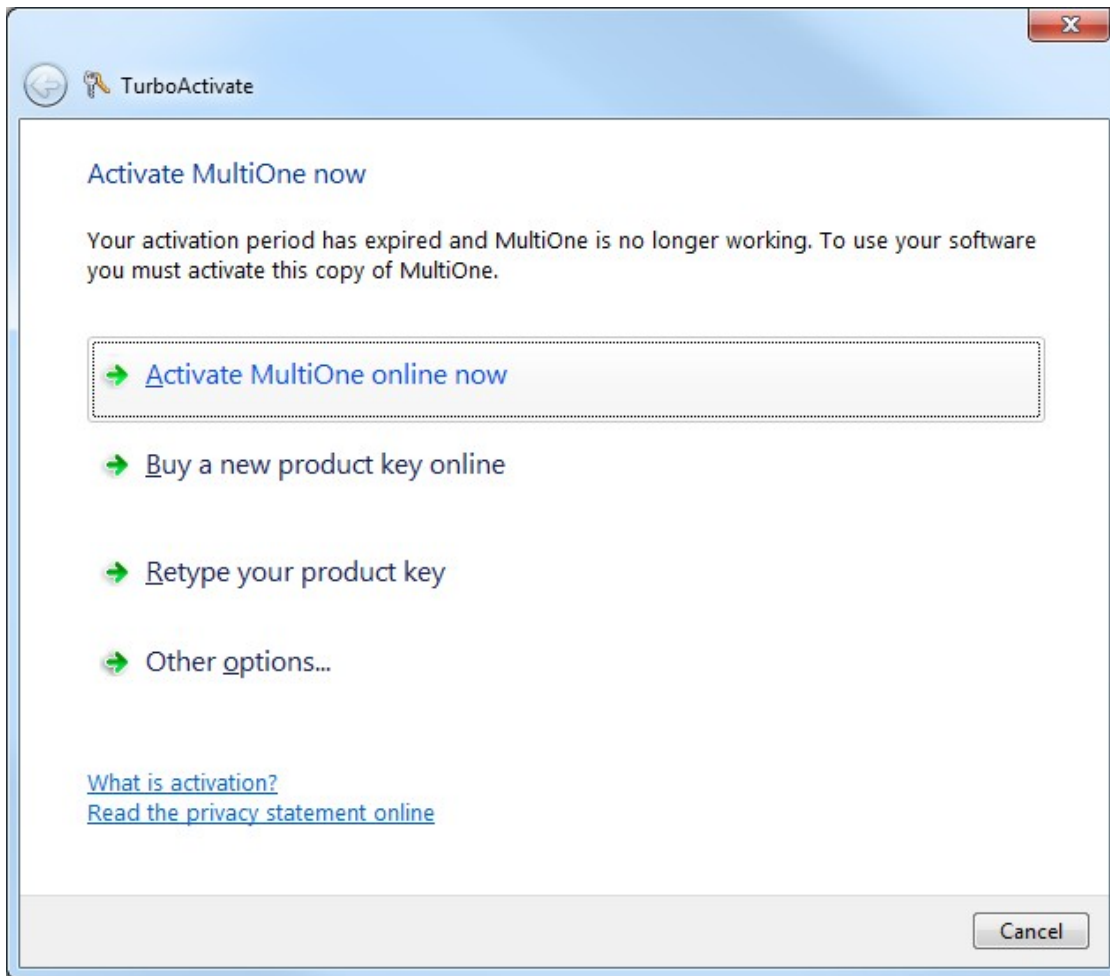

The other items on this window are less relevant. For completeness:

Select **Buy a new product key online** brings you to <https://www.signify.com/multioneconfigurator>. Actually buying keys online is not supported.

Once you have activated MultiOne with a user software key, you can select **Retype your product key** to switch to a different user software key.

The other items shown on the dialog are not supported.

If all goes well the activation is successful and the MultiOne user software key information screen should show the correct details and supported features corresponding to the user software key.

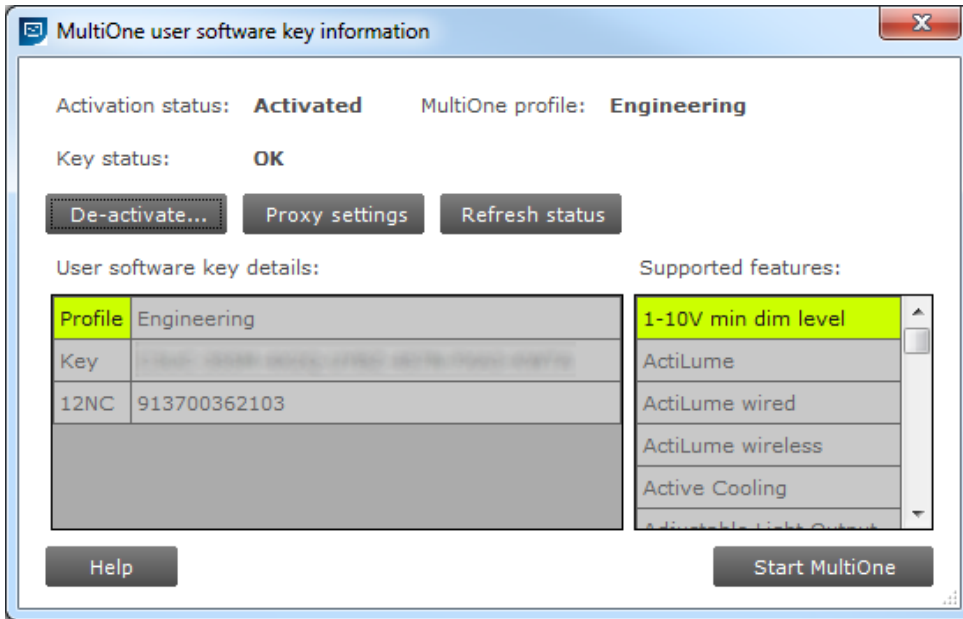

MultiOne is now ready for use!

Use the **Refresh status** button to refresh the license key status.

Note! Not all functionality described in this document applies to all MultiOne user software keys. For instance, some device features might not be available, or they might only be partially configurable.

7.2 Application mode selector

Once the activation process is done and when starting MultiOne, the first window that appears is the **Application Mode Selector**. Here, you can choose an application mode, based on the tasks you would like to perform. The application window also has links to the documentation.

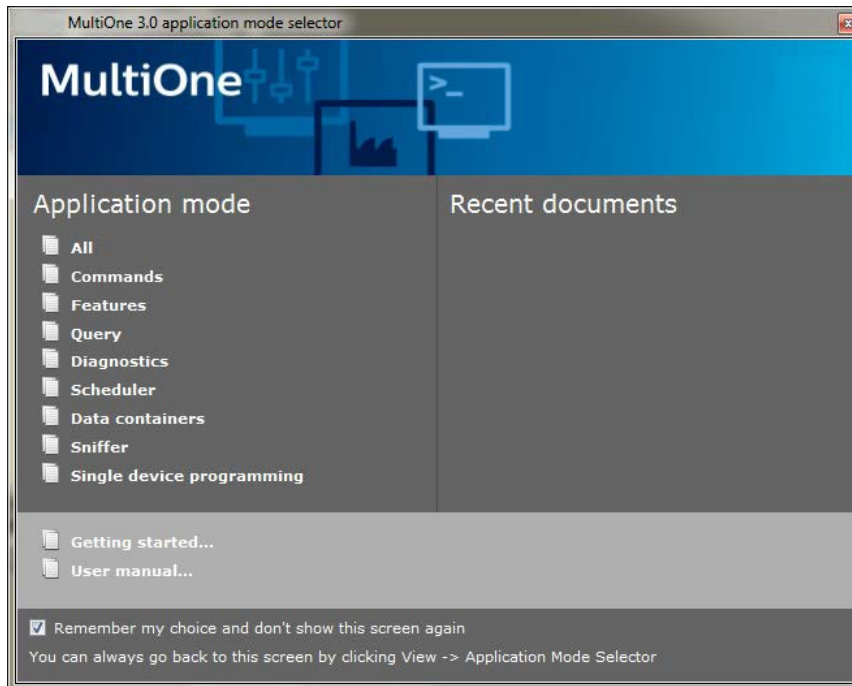

One of the modes is **Single device programming**. This mode simplifies some parts of the device configuration workflow when only one device has been connected. Single device programming is discussed in detail in chapter 0.

If you know that you will mostly perform the same tasks in the future, you can select **Remember my choice** and then click the appropriate application mode. MultiOne will record your choice and The **Application Mode Selector** will not appear again the next time MultiOne is started.

You can always go back to the **Application Mode Selector** by selecting **View → Application Mode Selector** from the main application window.

8 Selecting the interface

After the **Application Mode Selector** you must select the interface (USB2DALI, USB2ZigBee, Ethernet or SimpleSet) to work with.

8.1 Interface Auto detection

Interface can be automatically detected in case of DALI and SimpleSet.

On first start MultiOne will detect whether DALI or SimpleSet interfaces are connected to your PC or laptop.

- When only one interface is connected this one will be automatically chosen.
- Otherwise the Connection Settings window will appear.

Whenever MultiOne is started again and a previously selected interface is not connected anymore the following selection or action will take place:

- When only one interface is connected (independent of the type of interface) this one will be automatically chosen.
- When two interfaces are connected and one of them is of the same type as the previously selected interface this interface is automatically selected.
- Otherwise the Connection Settings window will appear.

Connecting multiple similar SimpleSet interfaces is currently only supported when using a LCN9610, LCN9620 or LCN9630 interface.

Notice! Whenever MultiOne is started again, if the previously selected interface is not either Dali or SimpleSet the auto detection will not work and MultiOne will start with the previously selected interface.

8.2 Interface Manual selection

First select the protocol: **DALI, ZigBee, Art-Net** or **SimpleSet**, when needed also indicate the selected interface and port or reader (in case of SimpleSet).

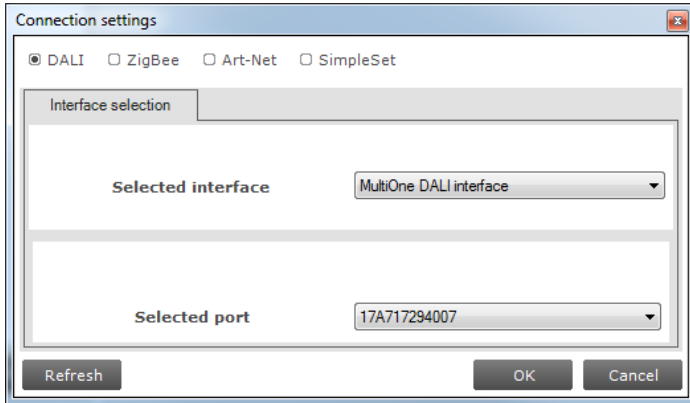

This protocol can always be changed later, by going to the **Tools** → **Connection settings**.

Notice! For DALI and SimpleSet the unique id of the interface is shown at the port/reader selection. This, to be able to identify which interface is used by which MultiOne instance (when configuring devices in parallel using multiple instances of MultiOne).

When a selected interface contains an outdated firmware version, MultiOne will show a message that it is unable to connect to the selected interface:

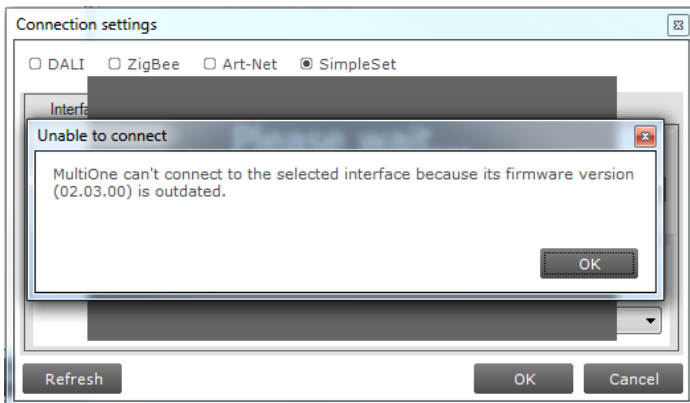

8.2.1 Art-Net

For the Art-Net protocol the delay time between sending frames is shown in the dialog. This delay time is set to 28ms and cannot be changed.

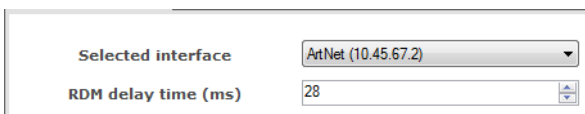

Note! Please make sure that the selected interface corresponds to the connected Art-Net network and has the correct IP address (for example use the 10.45.67.2 interface to connect with a Luminex network).

Note! Please make sure that Windows Firewall is not blocking the Art-Net network, this will cause troubles during scan.

9 Working with the LCN8600 MultiOne interface USB2DALI

Before using MultiOne with the USB2DALI interface make sure that all devices that need to be commissioned are connected to the mains and the DALI network. Finally the DALI network must be connected to one of the DALI connectors of the USB2DALI interface.

9.1 The main application window

If in the Application Mode Selector screen **All** is selected as application mode, the program will start as follows:

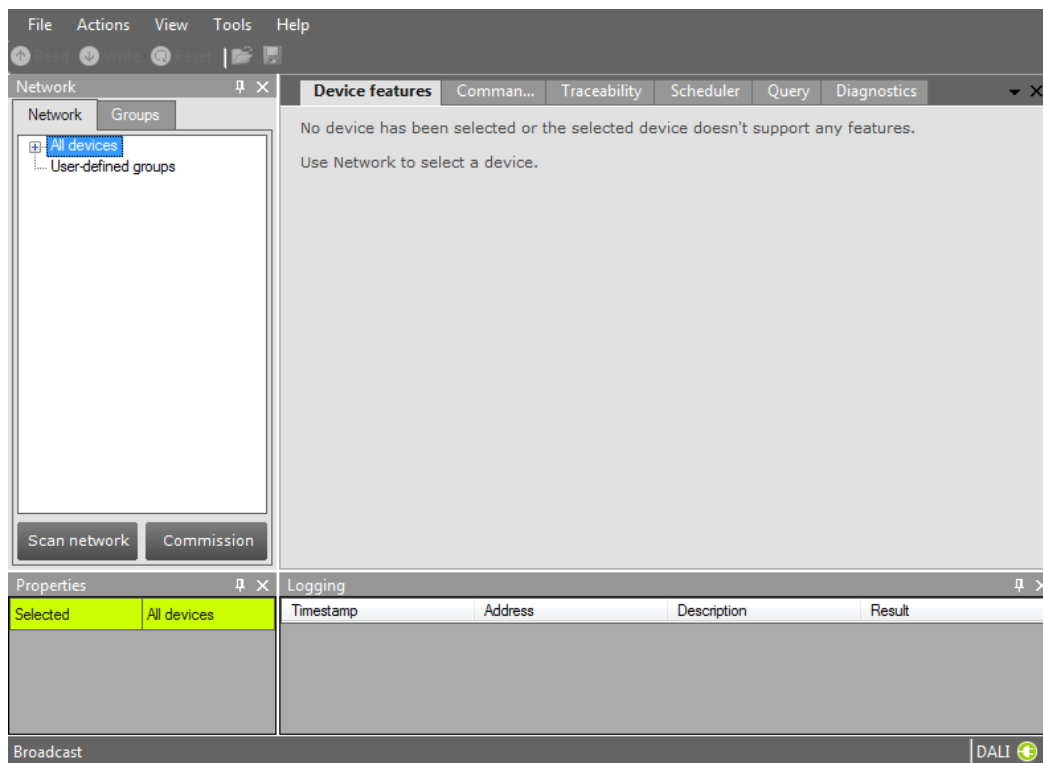

A more thorough explanation on how to communicate with devices can be found in chapters 12.2, 12.3, 12.11 and 12.12 of this manual.

9.2 Managing the DALI network

The **Network** panel is used to manage the connected DALI network. A number of tasks can be performed in the **Network**, each of which is detailed below.

9.2.1 Identifying devices

When starting MultiOne, the DALI devices connected to the USB2DALI interface are not automatically identified. There are two methods for identifying the devices with corresponding buttons in the **Network** on the left-hand side of the application window: **Scan network** and **Commission**.

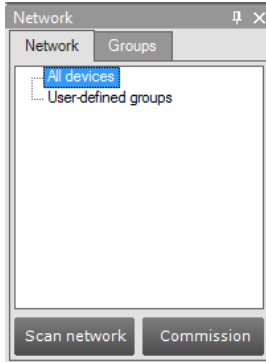

Note! A **Scan network** or **Commission** execution will place all found devices into manufacturer specific operating mode. Take care of this in case you need to use a connected driver in the DALI standard operating mode!

9.2.1.1 Scan network

There are two ways to scan a network: by short address or by random address. You can choose which method to use by going to **Tools->Preferences->DALI scanning**.

The key differences between scanning by short address and scanning by random address are the following:

- Scanning by short address will not change the random addresses of the connected devices. You should use this method if random addresses should not be affected. Additional user input might be required to find all connected devices (see below).
- Scanning by random address will change the random addresses of all connected devices. Any devices that do not have a short address yet will be assigned one automatically. Any devices that share the same short address will be automatically assigned (new) unique short addresses. This method is most likely to find all connected devices without user intervention.

Scan by short address. This method queries all short addresses without changing anything in the configurations of the connected devices. If all connected devices have a unique short address, this method will be able to find all devices. If, however, some devices share the same short address, or if there are devices without a short address (uncommissioned devices), additional decisions need to be made.

The following situations can occur while scanning a network by short address:

- There are uncommissioned devices. You will see the following dialog:

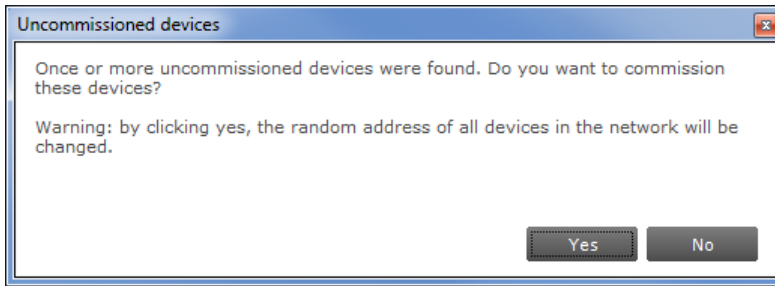

By clicking **Yes**, the uncommissioned devices will be commissioned. As a side effect, the random addresses of all connected devices will be changed.

By clicking **No**, no additional actions will be done and the **Network** will not display all devices.

- There are devices with the same short address. You will see the following dialog:

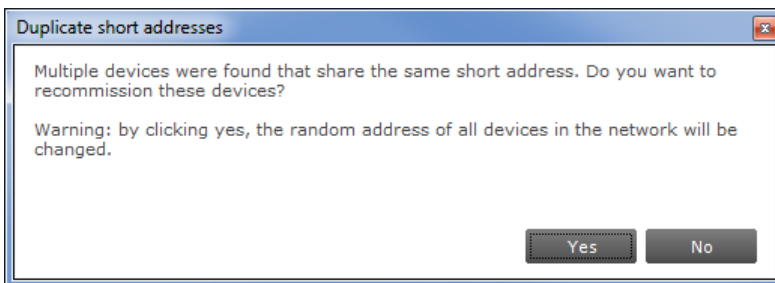

By clicking **Yes**, the devices that have the same short address will be recommissioned. As a side effect, the random addresses of all connected devices will be changed.

By clicking **No**, no additional actions will be done and the **Network** will not display all devices. Errors are likely to occur, indicated by a warning icon next to the name of the device(s).

- There are uncommissioned devices AND devices with the same short address. You will see the following dialog:

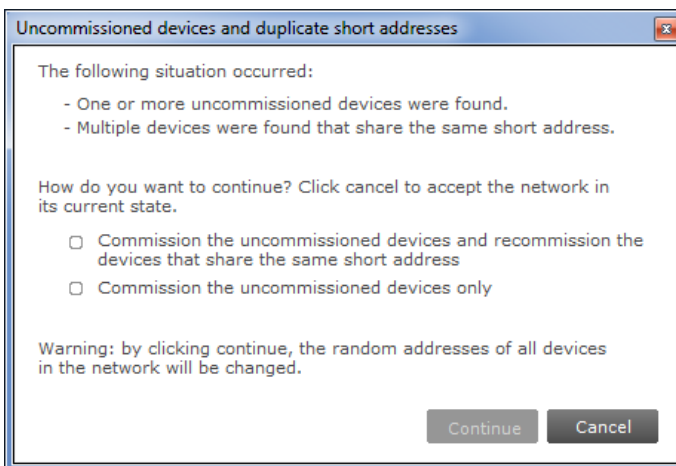

By choosing the first option, all uncommissioned devices will be commissioned, and all devices with the same short address will be recommissioned. By choosing the second option, only the uncommissioned devices will be recommissioned. By clicking **Cancel**, no additional actions will be done and the **Network** will not display all devices. Errors are likely to occur, indicated by a warning icon next to the name of the device(s).

Scan by random address. This method re-initializes the random addresses of all connected devices. If there are any uncommissioned devices, or devices that have the same short address, these devices will automatically be (re)commissioned.

9.2.1.2 Commissioning

All devices are given a new unique short address, starting at 0. Be aware that existing short addresses are erased and new short addresses are re-assigned to all connected devices. This procedure ensures that all devices have a short address and that there are no duplicate short addresses.

After commissioning or scanning the network, the list of identified devices is shown in the **Network**.

9.2.2 Selecting devices for communication

After having commissioned or scanned the network, the **Network** shows all devices present in the DALI network.

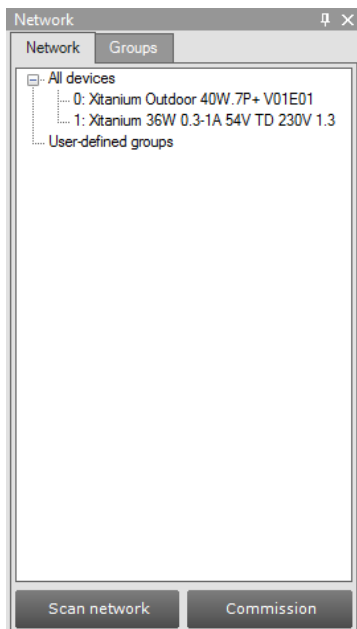

By clicking a device you will make that particular device the active one, meaning that all commands will be sent to this device only, and will be ignored by all other devices.

Besides selecting a single device for communication, it is also possible to communicate with groups of devices. The options are:

- All devices in the network. Select **All devices**. All commands will now be sent as broadcast commands. Note that unidentified but connected DALI devices will also respond to commands.
- All user-defined groups. Select **User-defined groups**. All commands will now be sent to devices that belong to a user-defined group. User defined groups are explained in the section 9.2.3.
- A specific user-defined group. Expand **User-defined groups** and select the desired user-defined group. All commands will now be sent to devices that belong to this specific user-defined group.

9.2.3 Managing user-defined groups

Using the **Network**, devices can temporarily be grouped into user-defined groups. The purpose of user-defined groups is that they facilitate easy clustering so that a number of devices can be addressed simultaneously.

The user-defined groups are lost when MultiOne is closed.

A new user-defined group can be created by right-clicking **User-defined groups** and selecting **Add new group**.

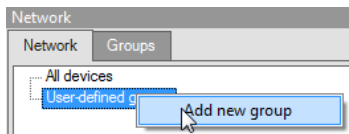

Alternatively choose **Actions** → **Add user-defined group**. A new group is created with a default name. To add a device to a user-defined group, right-click the device, select **Add to custom group** and select one of the available user-defined groups. Alternatively, the device can be dragged onto the desired user-defined group to add it to that group.

To immediately add a device to a new user-defined group, right-click a device and select **Add to user-defined group** and select **Add new group**.

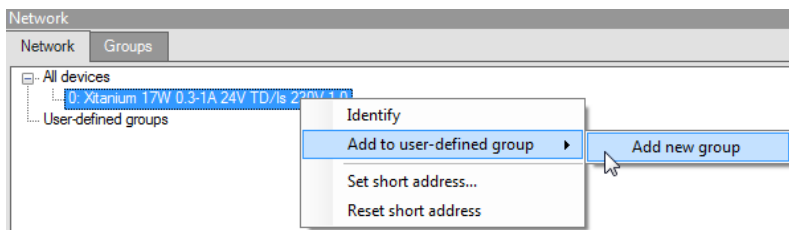

The user-defined group will be created and the selected device will be added to the newly created user-defined group.

To rename a user-defined group, right-click the group and select **Rename**. This will set the user-defined group to edit mode so that the new name can be entered.

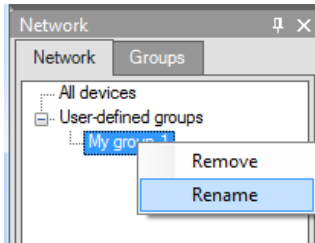

To remove a device from a user-defined group, right-click the device in the group and select **Remove**.

To remove an entire user-defined group (including its devices), right-click the group and select **Remove**.

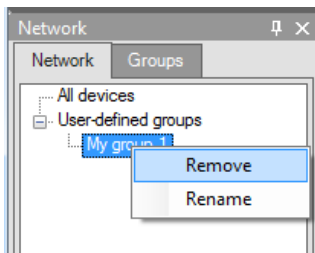

Note! The number of devices in a user-defined group is limited to 64.

9.2.4 Managing groups

Once all the devices in the DALI network are commissioned, i.e. have a unique short address, it is possible to work with DALI groups.

Select the **Groups** tab and click **Scan groups**. After having scanned the network for groups, the **Groups** tab shows all the DALI groups and the found devices for every group.

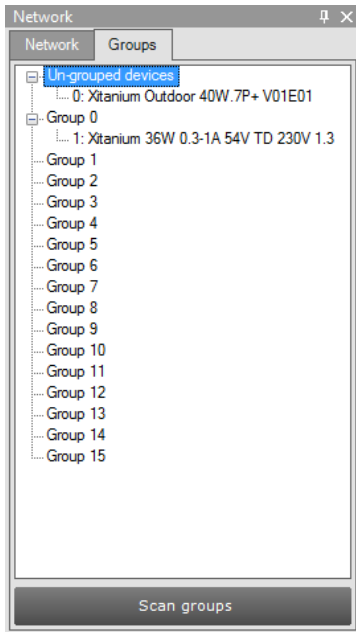

DALI groups are much more comprehensive than user-defined groups. The important difference is that with DALI grouping information is stored in the devices themselves. Therefore, DALI grouping is more permanent than user-defined grouping.

By clicking on a device you will make that particular device the active one, meaning that all actions will be performed on this device only, and will be ignored by all other devices.

The options are:

- With a right-click on an un-grouped device you can:
 - **Identify** the device
 - **Add to**, add the device to one group
 - **Configure...**, add device to multiple groups

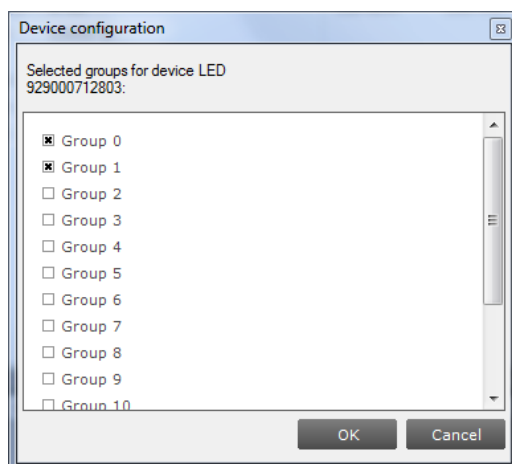

- With a right-click on a device in a group you can:
 - **Identify** the device
 - **Add to**, add the device to one other group
 - **Configure...**, add/remove device to/from multiple groups
 - **Remove**, remove device from current group

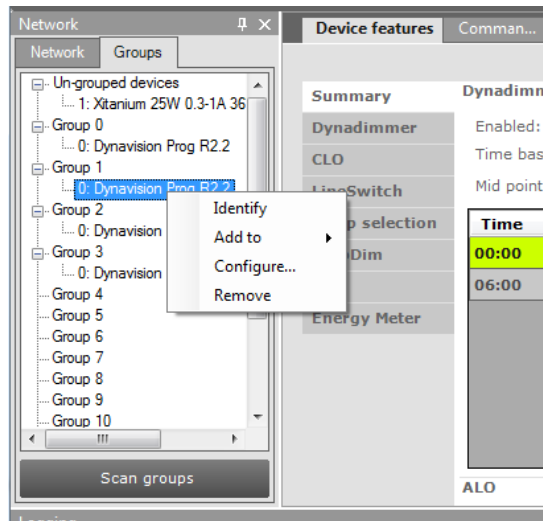

Besides selecting a single device for communication, it is also possible to communicate with a group of devices.

The options are:

- With a right-click on a group you can:
 - **Identify** the devices in the group
 - **Configure...**, add/remove multiple devices to/from the group
 - **Clear group**, remove the devices from the group

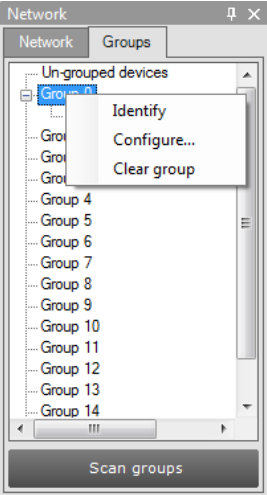

Note! The number of devices in a DALI group is limited to 64.

10 Working with the LCN8650 MultiOne interface USB2ZigBee

10.1 The main application window

If in the Application Mode Selector screen **All** is selected as application mode, the program will start as follows:

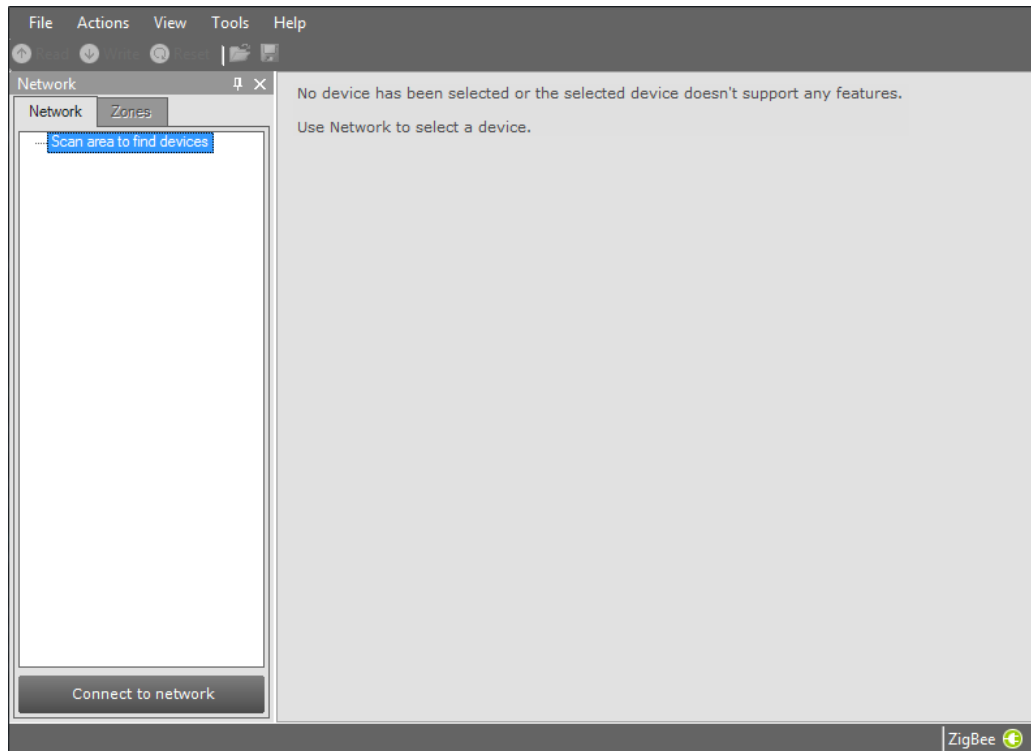

10.2 Connecting to a ZigBee network

The **Network** panel is used to manage a connected ZigBee network. A number of tasks can be performed in the **Network** panel, each of which is detailed below.

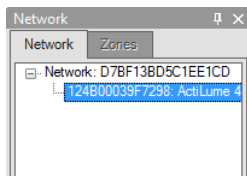

10.2.1 Identifying devices

The ZigBee devices and networks in the area of the USB2ZigBee interface are not automatically known.

To find devices and networks in the area click **Connect to network**: MultiOne scans for an open network in the area and connects to the network. After connecting has finished, the network and the found devices are shown in the **Network** panel.

10.2.2 Selecting devices for communication

After having connected to the network, the **Network** panel shows all devices and the network to which MultiOne is connected. By clicking on a device or network you will make that particular device or network the active one, meaning that all actions will be performed on this device or network only, and will be ignored by all other devices or networks.

With a right click on a device you can:

- **Identify** the device

10.3 Advanced commissioning

To commission a ZigBee network, right click the **Network** panel and choose **Enable advanced commissioning**.

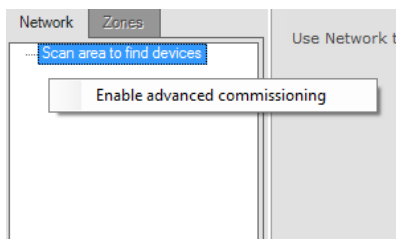

The **Network** panel switches to a different view making it possible to manage ZigBee networks.

10.3.1 Identifying devices

Click **Scan area** to scan for all the devices and network in the area of the USB2ZigBee interface. After scan has finished the devices and networks in range of the interface are shown in the **Network** panel.

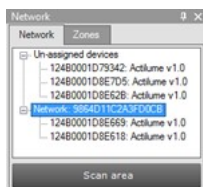

10.3.2 Managing networks

The options are:

- With a right-click on an unassigned device you can:

- **Add to**, move the device to an existing network or move the device to a new network
- With a right-click on a device in a network you can:
 - **Add to**, move the device to an existing network or move the device to a new network
 - **Reset**, from network, the device will become unassigned. If the network becomes empty, the network will be removed
- With a right-click on a network you can:
 - **Query network**, to find all devices in the network, including the devices that are out of range of the USB2ZigBee interface
 - **Open network**, to add more devices

10.3.3 Managing zones

Once you have scanned the area and found devices and networks in range, it is possible to scan a specific network for zones. Select the **Zones** tab, select the **Network** and click **Scan zones**. After having scanned the network, the **Zones** tab shows the found devices and zones within the specified network.

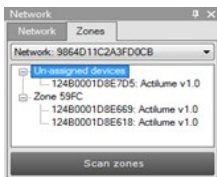

By clicking on a device or zone you will make that particular device or zone the active one, meaning that all actions will be performed on this device or zone only, and will be ignored by all other devices.

- With a right-click on an unassigned device you can:
 - **Identify** the device
 - **Add to**, move the device to an existing or new zone
- With a right-click on a device in a zone you can:
 - **Identify** the device
 - **Add to**, move the device to an another or new zone
 - **Configure...**, move the device to another zone

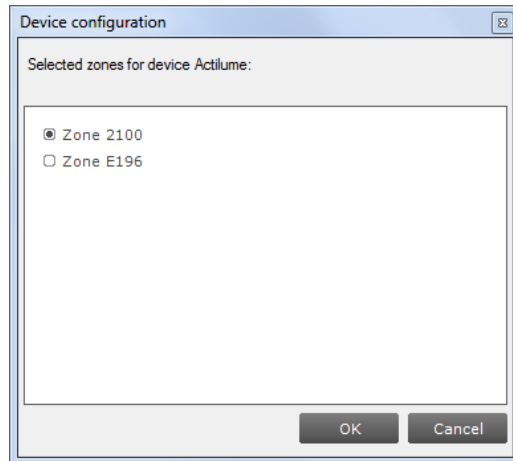

- **Remove**, the device will become unassigned. If the zone becomes empty, the zone will be removed
- With a right-click on a zone you can:
 - **Identify** the zone
 - **Configure...**, add/remove multiple devices to/from the zone. If other zones become empty, they will be removed

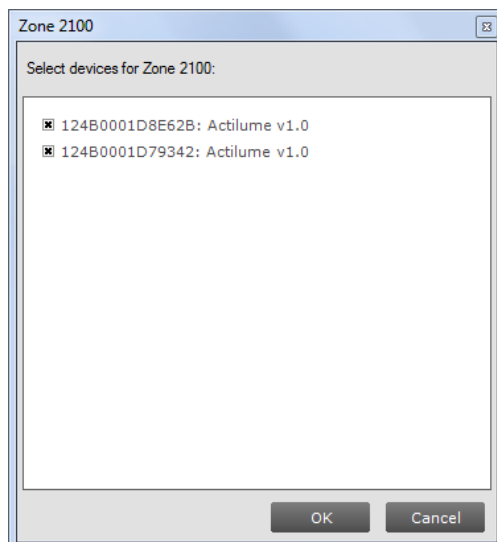

- **Remove zone**, the zone will be removed and the devices will become unassigned

11 Working with the MultiOne SimpleSet interface(s)

11.1 The main application window

If in the Application Mode Selector screen **All** is selected as application mode, the program will start as follows:

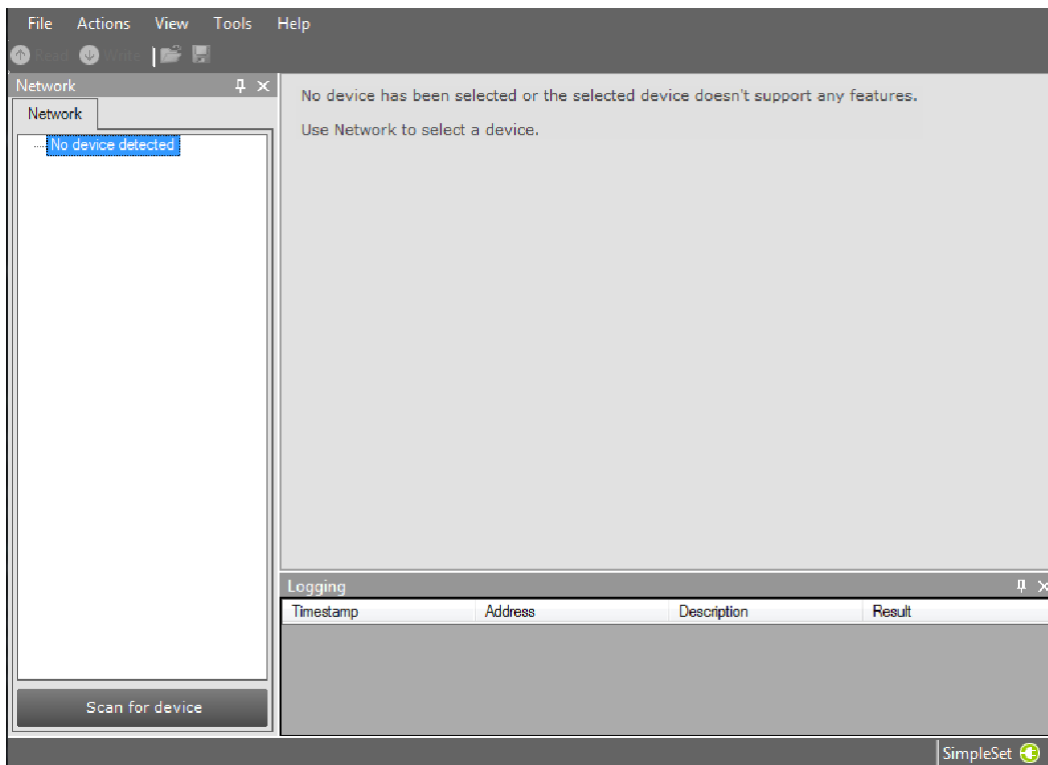

11.2 Scanning a SimpleSet device

The **Network** panel is used to manage the scanned SimpleSet devices. A number of tasks can be performed in the **Network** panel, each of which is detailed below.

11.2.1 Identifying devices

The SimpleSet device near the SimpleSet interface is not automatically known by MultiOne. To get the device click **Scan for device**: a pop-up will appear indicating the device must touch the interface.



Touch and hold the device close to the SimpleSet interface until the scan has completed. The scanned device will be shown in the **Network** panel.

11.2.2 Auto read

After a device gets selected all features are shown on the **Features** tab and auto read gets activated. Auto read automatically start reading the configuration of all features. Progress is shown as described in chapter 12.2

11.3 Selecting devices for communication

After having scanned the SimpleSet device, the **Network** panel shows the device. By clicking on a device you will make that particular device the active one, meaning that all actions will be performed on this device only, and will be ignored by all other devices.

11.4 Starting communication

In order to communicate with a SimpleSet device, the device has to touch the SimpleSet interface. Before starting the communication MultiOne will show a pop-up when the device is not near the SimpleSet interface. This pop-up waits until the device and the SimpleSet interface touch, or disappears after 20 seconds. After touching the action will be executed. Touch and hold the device close to the SimpleSet interface until all communication has finished.

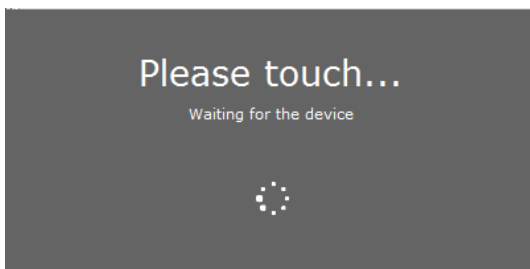

12 Working with MultiOne

12.1 Viewing device properties

Whenever a device is selected in **Network**, the **Properties** display a number of details for the selected device.

Properties	
Selected	Xitanium 40W 1.1A 54V DALI SR INT
Version	0.1
12NC	929000724613
Device type	LED
Firmware revision	1082
Device identifier	E00258D265175078

12.2 Communicating with a device

Initiating communication with a device is done by first selecting the device (left-click the device in **Network**) and then clicking **Read**, **Write** or **Reset** on the toolbar.

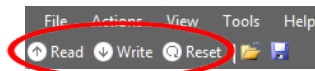

When the **Commands** tab or the **Scheduler** tab is active, these buttons are unavailable. When the **Query** tab is active, all queries are executed when clicking **Read**. When the **Diagnostics** tab is active, all diagnostics information is read (if available in the selected device) when clicking **Read**. The **Write** action is only available on the **Diagnostics** tab when the selected device has 1 or more features. When the Energy Meter is active, all data regarding **Energy Meter** is read (if available in the selected device) when clicking **Read**. When the **Device features** tab is active, the **Read** and **Write** actions are available. The **Reset** action is only available on the **Device features** tab when the selected device has 1 or more features that are resettable. The **Reset** action will set a feature to its factory defaults.

Reading, writing and resetting will always take a few seconds. Operation progress is shown on the status bar of the main application window. On the **Device features** and **Diagnostics** tab, per-feature progress is shown on each of the feature selection tabs. When all information has been successfully read or written, a green tick mark will appear and the text **Status: OK** is shown. If anything goes wrong, a red icon and the text **Status: failed** is shown. When on the **Device features** tab, point your mouse to each status icon to see a more detailed description of the communication result.

Apart from using **Read** and **Write** on the toolbar, you can directly send DALI commands. This can be done on the **Commands** tab and the **Scheduler** tab.

In the **Preferences** window it is possible to enable extra verification when writing (see chapter 12.22).

12.3 Configuring device features

You can configure all features that are supported by a specific device. For any device selected in the **Network**, the **Device features** tab displays the set of device features that corresponds to this device. Upon selecting another device, the **Device features** tab will be updated as well. This mechanism ensures that only the features supported by the selected device can be configured.

The **Device features** tab has a panel with a column of tabs on the left-hand side. Each feature has its own tab. For most devices a **Summary** tab is available as well.

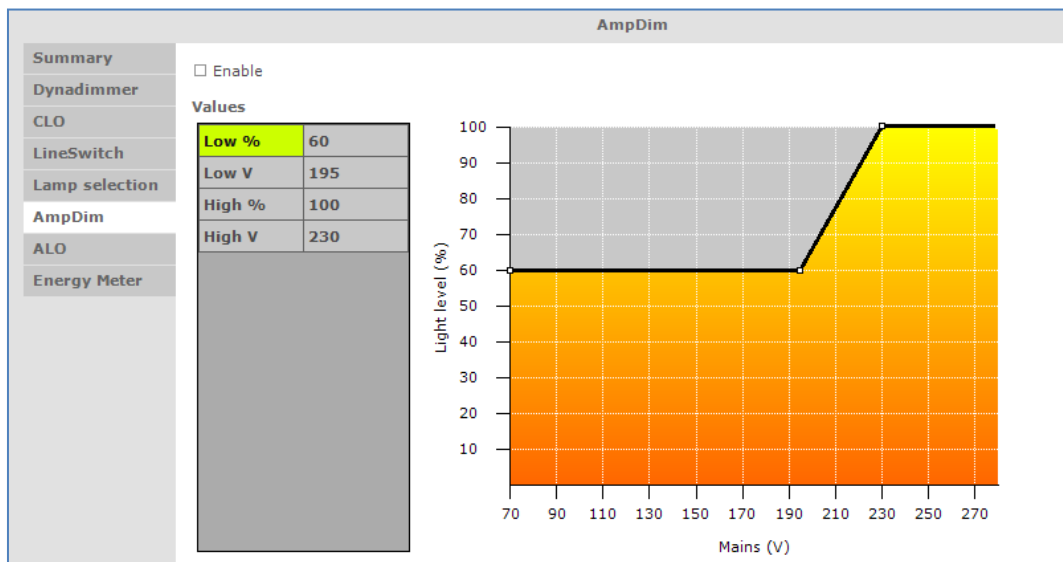

To make sure that the feature information in the **Device features** tab corresponds to the selected device, click **Read** on the toolbar.

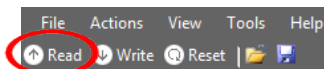

Note that some features might be OEM Readout-protected. OEM Readout-protected features are indicated by a padlock icon in the **Read feature configuration** window.

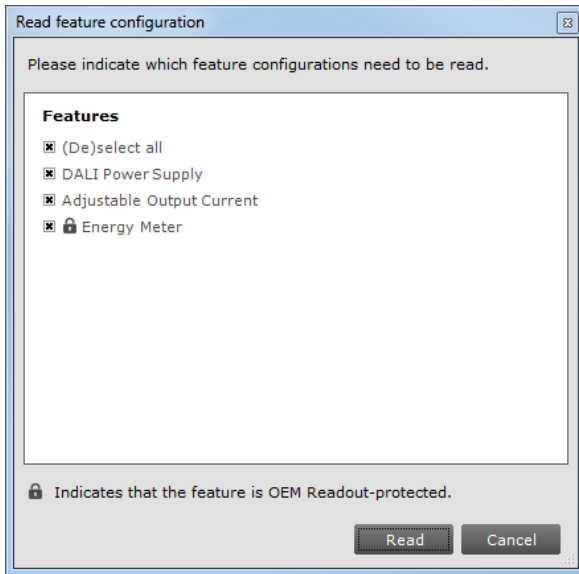

If an OEM Readout-protected feature is read, a dialog will appear asking for an access level and a password.



After providing a correct access level and password, and clicking **OK**, the OEM Readout-protected features will be read. By clicking **Cancel** none of the selected features will be read. If an incorrect access level and/or password were provided, the OEM Readout-protected features will receive a status icon indicating failure (see below).

To make sure that the feature information is stored in the selected device, click **Write** on the toolbar. If you want to reset certain features to its default settings, click **Reset** on the toolbar. Be aware that you need to click the **Read** button afterwards to reload the reset values.

Note also that some features might be OEM Write-protected. OEM Write-protected features are also indicated by a padlock icon in the **Write feature configuration** window.

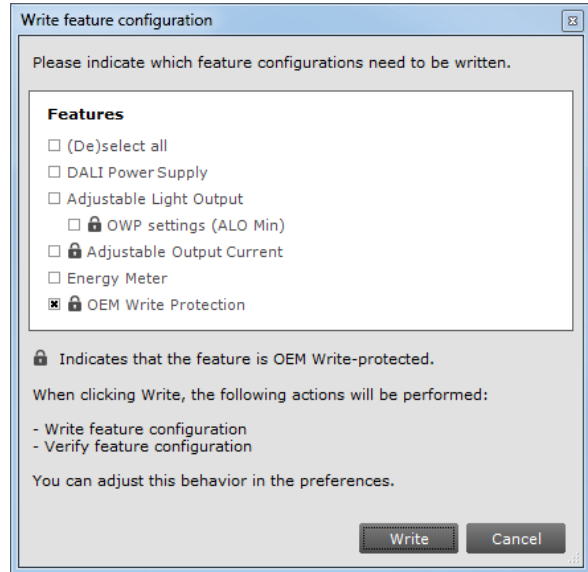
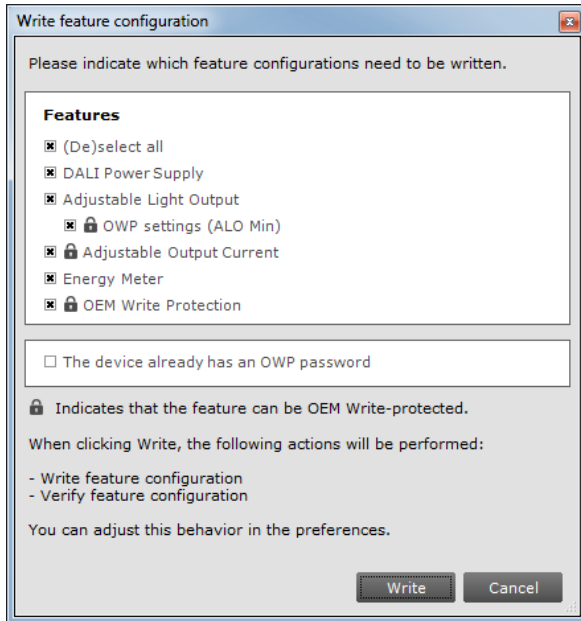

Also note that you must select a check box to indicate that the device already has an OWP password configured. MultiOne does not know this, because the configuration of a device is not always read before a Write action takes place. When the check box is selected and the **Write** button is clicked, a dialog will appear asking for a password. When the OWP configuration was already read, MultiOne knows the current OWP configuration and the check box will not be shown. In that way, MultiOne will show the password dialog only in case if OWP is enabled in the device and a write protected feature is selected.

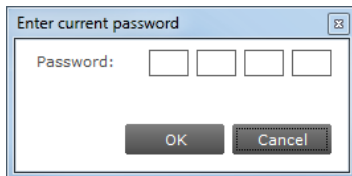

After providing a correct password and clicking **OK**, the OEM Write-protected features will be written. By clicking **Cancel** none of the selected features will be written. If an incorrect password was provided, the OEM Write-protected features will receive a status icon indicating failure (see below).

For **Read**, **Write** and **Reset** actions, status icons will be shown when a feature is being read or written. There are four different colors used for the icons: red, orange, green and grey.

Red means that the read or write action failed. The green icon indicates that reading or writing was successful and that all the data was sent to the driver. This does not mean that all data is actually received (see Write and Verify in chapter 12.18.1). The grey icon is used to display that the read or write action is pending for the specific feature. An orange icon indicates that the last write action for the feature was not

successful and that the feature might not be configured correctly; the orange indicator is only applicable for SimpleSet devices.



In the following sections you will find an overview of all supported device features in alphabetical order. Features typically belong to one or two product groups (LED, HID or FLUO), but this does not mean that every device belonging to a certain product group will automatically support all of its features listed here. For an overview of supported device features see [Supported features](#).

12.3.1 0-10V / 1-10V (SR bridge)

Product group

CONTROL

Curve selection: User specified ▼

User specified curve

Dim level [%]	0-10V / 1-10V
1	1.0
7	1.5
13	1.9
19	2.3
25	2.8
31	3.2
37	3.6
42	4.0
47	4.3
52	4.7
57	5.0
62	5.4
67	5.7
72	6.1
77	6.4
83	6.9
89	7.3
95	7.7
100	8.0

Description

The 0-10V interface requires special configuration to match the 0-10V (or 1-10V) dimming curves of the connected drivers. The SR Bridge needs to correctly and accurately translate the DALI arc power commands to the correct 0-10V dimming voltages for the connected drivers such that the appropriate LED driver output current is achieved. This feature is used to configure the dimming curve by either selecting a predefined fixed curve or specifying a curve manually.

Usage

Use the drop down box to select the 0-10V (or 1-10V) curve that should be used for the SR Bridge. There are four fixed curves (1-10V curved, 0-10V linear, 1-9V linear and 0-10V logarithmic) selectable and there is a possibility to select the **User specified** option.

Selecting the 'User specified' ZTV curve makes the **User specified curve** properties visible which can be used to construct a specific 0-10V (or 1-10V) curve. Both the **Dim level** and **0-10V / 1-10V** values can be changed to create a specific 0-10V (or 1-10V) curve.

Note! 0-10V linear curve also includes the European 1-8V linear curve.

12.2 0-10V / 1-10V (LED driver)

Product group

LED

The screenshot shows a configuration panel for LED driver dimming. It includes a slider and text input for 'Minimum dim level' set to 0%, a dropdown for 'Curve selection' set to '1-10V curved', a checkbox for 'Enable dim to off' which is unchecked, and two dropdown menus for 'Fade on time' (set to 0 s) and 'Fade off time' (set to 2 s).

Description

Use this feature to set the minimum dim level when using 1-10V.

Usage

- Use the slider or the text field to select a value. The value represents the light level.
- Use the drop down box to select the wanted curve selection (0-10V linear, 1-9V linear, 1-10V curved or 0-10V logarithmic). The curve selection is device dependent. **Note!** 0-10V linear curve also includes the European 1-8V linear curve.
- Use the Enable dim to off checkbox to enable or disable the dim to off functionality.
- Use the first drop down box to select the wanted fade on time value. This value represents the time to turn on and start dimming up to target dim level.
- Use the second drop down box to select the wanted fade off time value. This value represents the time to start dimming down until the light is off.

12.3 ActiLume General

Product group/family

CONTROL/ActiLume DALI

Configuration:	Parallel link
Mode:	1
IR channel:	A
Region:	EU
Occupancy sharing:	Mode based
<input checked="" type="checkbox"/> Local daylight sensing	
<input checked="" type="checkbox"/> Local presence sensing	
Presence sensor sensitivity:	High
Light sensor reference point:	600 lx
Night mode	
Hold time:	5 minutes
Background level:	20%
Prolong time:	15 minutes
BMS	
<input type="checkbox"/> Send HVAC/sunblind messages to BMS	
<input type="checkbox"/> DALI occupancy reporting	

Description

Use this feature to configure general ActiLume settings.

Usage

Use the various drop down boxes, check boxes and text fields to make a configuration.

Please refer to the ActiLume DALI gen2 Application Guide for further details.

Product group/family

CONTROL/ActiLume Wireless

Mode:	<input type="text" value="1"/>
IR channel:	<input type="text" value="H"/>
Region:	EU
<input type="checkbox"/> 100 hour burn-in	
Light sensor reference point:	150 lx
Reference point correction factor:	<input type="text" value="88"/> %
Occupancy mode override:	<input type="text" value="Path of egress"/>

Description

Use this feature to configure general ActiLume settings.

Usage

Use the various drop down boxes, check boxes and text fields to make a configuration.

Please refer to the ActiLume Wireless Application Guide for further details.

12..4 ActiLume Mode

Product group/family

CONTROL/ActiLume DALI

Hold time:	<input type="text" value="15"/>	half min														
Prolong time:	<input type="text" value="0"/>	min <input type="checkbox"/> Infinite														
Smart time:	<input type="text" value="10"/>	min														
Grace time:	<input type="text" value="10"/>	s <input checked="" type="checkbox"/> Fade during grace period														
Light status on power up:	<input type="text" value="Lights off"/>															
Retention time:	<input type="text" value="15"/>	min														
Background level:	<input type="text" value="10"/>	%														
Dwell time:	<input type="text" value="0"/>	s														
Light sensor reference point:	<input type="text" value="210"/>	lx														
Occupancy mode:	<input type="text" value="Auto on / auto off"/>	Group 1	<input type="text" value="Auto on / auto off"/>	Group 2	<input type="text" value="Auto on / auto off"/>	Group 3	<input type="text" value="Auto on / auto off"/>	Group 4	<input type="text" value="Auto on / auto off"/>	Group 5						
Daylight dependent override:	<input checked="" type="checkbox"/>	<input type="checkbox"/>	<input type="checkbox"/>	<input type="checkbox"/>	<input type="checkbox"/>	<input type="checkbox"/>	<input type="checkbox"/>	<input type="checkbox"/>	<input type="checkbox"/>	<input type="checkbox"/>						
Daylight dependent switching:	<input checked="" type="checkbox"/>	<input type="checkbox"/>	<input type="checkbox"/>	<input type="checkbox"/>	<input type="checkbox"/>	<input type="checkbox"/>	<input type="checkbox"/>	<input type="checkbox"/>	<input type="checkbox"/>	<input type="checkbox"/>						
Daylight dependent regulation:	<input checked="" type="checkbox"/>	<input checked="" type="checkbox"/>	<input checked="" type="checkbox"/>	<input type="checkbox"/>	<input type="checkbox"/>	<input type="checkbox"/>	<input type="checkbox"/>	<input type="checkbox"/>	<input type="checkbox"/>	<input type="checkbox"/>						
Daylight regulation offset:		<input type="text" value="30"/> %	<input type="text" value="50"/> %	<input type="text" value="0"/> %	<input type="text" value="0"/> %	<input type="text" value="0"/> %	<input type="text" value="0"/> %	<input type="text" value="0"/> %	<input type="text" value="0"/> %	<input type="text" value="0"/> %						
Switch on level prior to DDR:	<input type="text" value="20"/> %	<input type="text" value="20"/> %	<input type="text" value="100"/> %	<input type="text" value="100"/> %	<input type="text" value="100"/> %	<input type="text" value="100"/> %	<input type="text" value="100"/> %	<input type="text" value="100"/> %	<input type="text" value="100"/> %	<input type="text" value="100"/> %						
Mode based linking																
Reaction to mode:	1 <input type="text" value="Ignore"/>	5 <input type="text" value="Ignore"/>	9 <input type="text" value="Ignore"/>	13 <input type="text" value="Ignore"/>	2 <input type="text" value="Ignore"/>	6 <input type="text" value="Ignore"/>	10 <input type="text" value="Ignore"/>	14 <input type="text" value="Ignore"/>	3 <input type="text" value="Ignore"/>	7 <input type="text" value="Ignore"/>	11 <input type="text" value="Ignore"/>	15 <input type="text" value="Ignore"/>	4 <input type="text" value="Ignore"/>	8 <input type="text" value="Ignore"/>	12 <input type="text" value="Ignore"/>	16 <input type="text" value="Ignore"/>
Group based linking																
Base group:	<input type="text" value="Local occupancy"/>															
Secondary group:	<input type="text" value="Local occupancy"/>															

Description

Use this feature to configure ActiLume settings that apply to the system's modes. For ActiLume DALI gen2, up to 16 modes are shown, each of which has its own feature tab on the left-hand side. Use the ActiLume Mode feature to configure settings for each individual mode.

Usage

Use the various drop down boxes, check boxes and text fields to make a configuration. Click the **Reset to factory defaults** button to reset the current mode to the factory defaults.

Please refer to the ActiLume DALI gen2 Application Guide for further details.

Product group/family

CONTROL/ActiLume Wireless

Hold time:	<input type="text" value="30"/>	half min	
Prolong time:	<input type="text" value="0"/>	min	<input type="checkbox"/> Infinite
Light status on power up:	<input type="text" value="Lights off"/>		
Background level:	<input type="text" value="10"/>	%	
Occupancy mode:	<input type="text" value="Auto on / auto off"/>		
Light sensor reference point:	<input type="text" value="210"/>	lx	

Description

Use this feature to configure ActiLume settings for that apply to the system's modes. For ActiLume Wireless, up to 32 modes are shown, each of which has its own feature tab on the left-hand side. Use the ActiLume Mode feature to configure settings for each individual mode.

Usage

Use the various drop down boxes, check boxes and text fields to make a configuration.

Please refer to the ActiLume Wireless Application Guide for further details.

12.5 ActiLume Scene

Product group/family

CONTROL/ActiLume DALI

	Group 1	Group 2	Group 3	Group 4	Group 5
Dim behavior:	Manual dim level ▼	Manual dim level ▼	Manual dim level ▼	Manual dim level ▼	Manual dim level ▼
Dim level:	50 %	50 %	50 %	50 %	50 %

Description

Use this feature to configure ActiLume settings that apply to the system’s scenes. For ActiLume DALI gen2, 5 scenes are shown, each of which has its own feature tab on the left-hand side. Use the ActiLume Scene feature to configure settings for each individual scene.

Usage

Use the various check boxes and text fields to make a configuration.

Please refer to the ActiLume DALI gen2 Application Guide for further details.

12.6 Active Cooling

Product group

LED

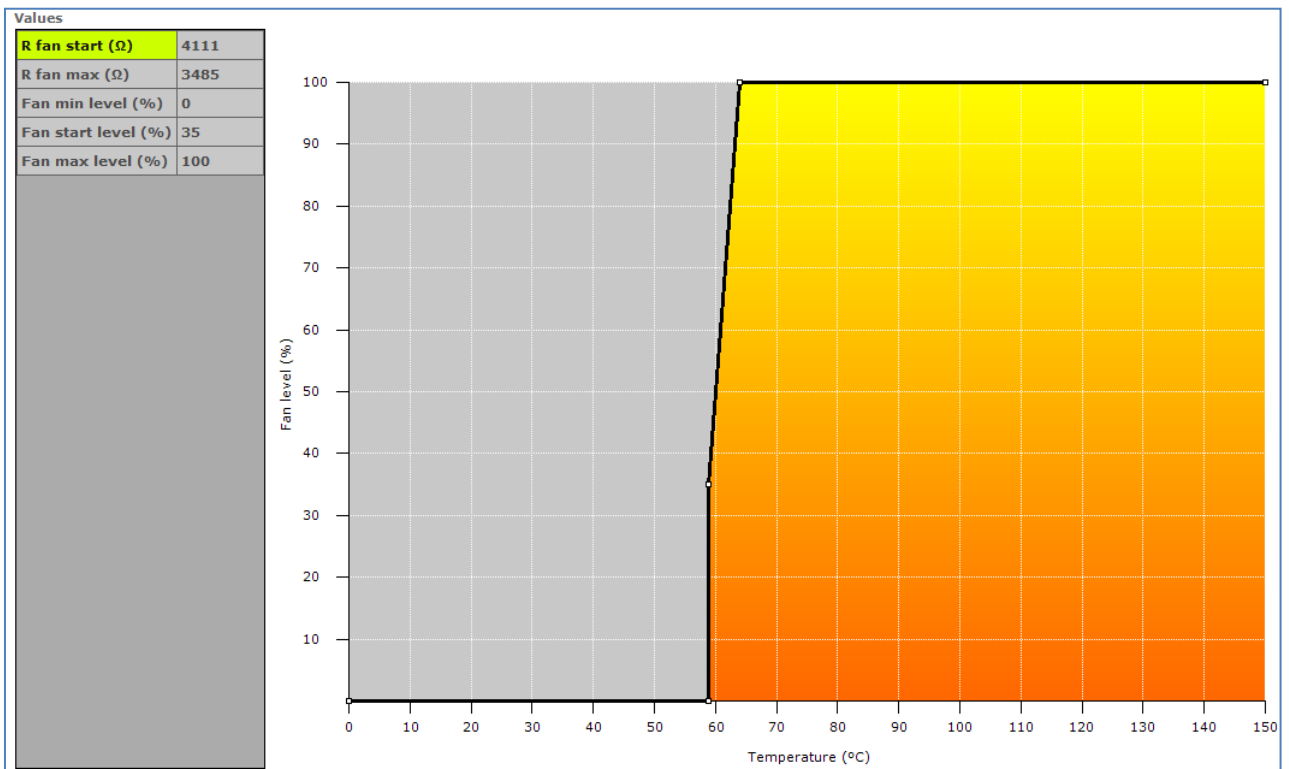

Description

Use this feature to control the fan of the LED module and minimize audible noise from the active cooling unit. The driver increases the fan output level (and so the speed of the fan) when temperature of the LED module becomes too high. When the fan output level increases the temperature of the LED module should be reduced.

The customer can specify the temperature limits to make sure the fan output level is kept as low as possible and will only increase when needed so the audible noise is reduced.

Usage

Drag the points or the lines in the resulting graph to adjust the configuration. Alternatively, use the table to enter values directly.

Note! For a detailed technical description of the characteristics of the device model, like constraints and limitations, please refer to [Device-specific technical description](#).

12..7 Adjustable Light Output

Product group

HID, LED

<input checked="" type="checkbox"/> Enable	
ALO:	<input type="range" value="90"/> 90 %
ALO min:	<input type="range" value="50"/> 50 %

Description

Use the Adjustable Light Output (ALO) feature to regulate the light output to a desired optimum value. You can create a "virtual lamp" with output different than what the standard wattages offer.

Usage

Select the **Enable** check box to use this feature. Use the slider or the text field to select an **ALO** value. The value represents the light level. The **ALO min** value (only available for LED devices, not available for all devices) can be used to set the lowest possible ALO value.

12..8 Adjustable Output Current

Product group

LED

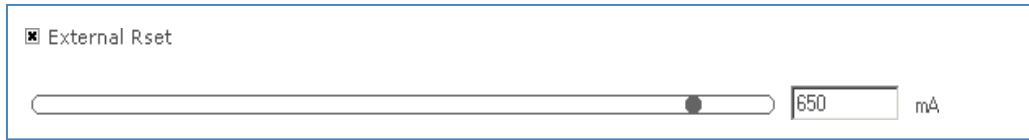

Description

Use this Adjustable Output Current (AOC) feature to adjust the output current to a desired optimum value. You can create a “virtual lamp” with output different than what the standard wattages offer.

Usage

The current can be set in two ways:

- Select the **External Rset** check box: Adjustment of the output current is not configured using MultiOne, but the value of an external resistor adjusts the output current

OR

- Use the slider or the text field to select a value. The value represents the nominal output current

12..9 Adjustable Output Current Multi-Channel

Product group

LED

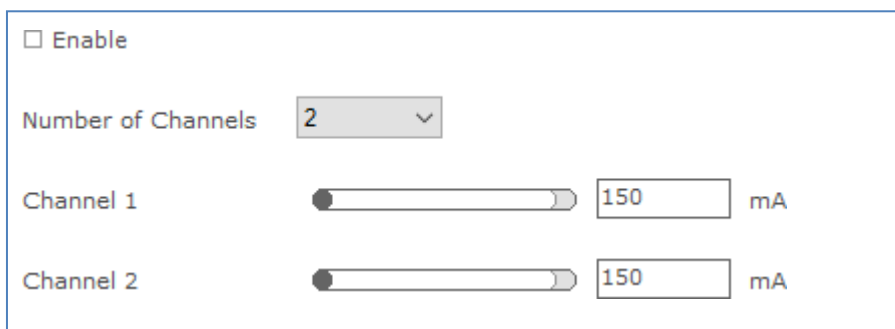

Description

Use the Adjustable Output Current Multi-Channel (AOCMC) feature to adjust the output current to a desired optimum value for each active channel. You can create a “virtual lamp” with output different than what the standard wattages offer.

Usage

Select the **Enable** check box to enable this feature.

Select the **Number of Channels** box to define the number of channels that will be available to adjust the output current. Use the slider or the text field to select a value for each active channel. The value represents the nominal LED output current.

Note! There is a range limit in the values that corresponds with the maximum and minimum values of the total nominal LED current that is used in MultiOne.

12..10 Adjustable Startup Time

Product group

LED



Description

At power on, the fast fade-up of light can be unpleasant in certain applications. To avoid such a situation, the device fade-up time at startup can be adjusted.

Usage

Use the slider or the text field to select a value. The value represents the start fade-up time in milliseconds.

12..11 AmpDim

Product group

HID, LED

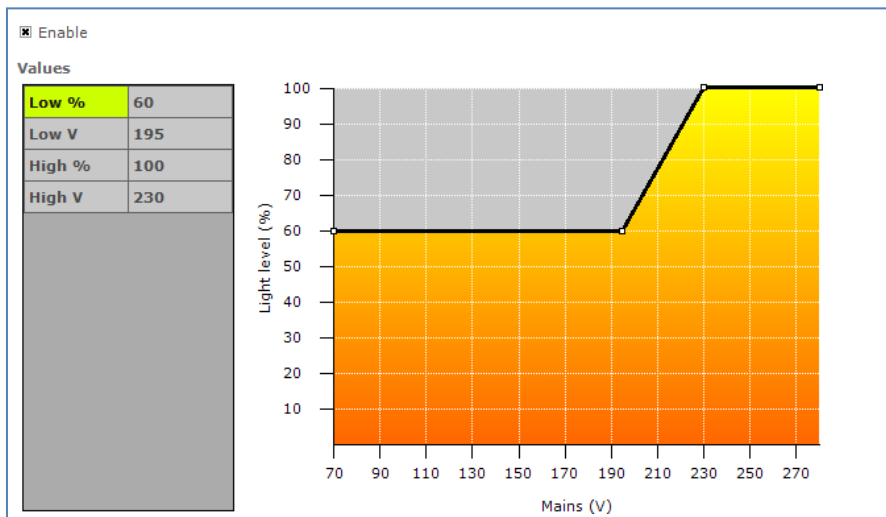

Description

Use this feature to adjust the light output of a lamp by adjusting the mains voltage of the device.

Usage

Select the **Enable*** check box to use this feature (note that LED devices do not have this check box). Drag the points or the lines in the graph to create the desired configuration. Alternatively, use the table to directly enter values.

Note! For a detailed technical description of the characteristics of the device model, like constraints and limitations, please refer to [Device-specific technical description](#).

* **Note!** If the device supports interface selection, then this feature can only be enabled through the interface selection and the enable will not be shown here.

12..12 Auxiliary Power Supply Voltage**Product group**

LED

Output voltage:	24V
-----------------	-----

Description

Use this feature to configure the Auxiliary Power Supply feature in the device.

Usage

Select the **Output voltage** box to define the desired output voltage for the auxiliary supply.

12..13 Coded Light On and Off**Product group**

LED

<input checked="" type="checkbox"/> Enable
--

Description

Use this feature to enable/disable the Coded Light feature in the device.

Usage

Select the **Enable** check box to use this feature.

12..14 Coded Mains**Product group**

LED

Enabled

Override

Fade time: 5,7 s

Fast fade time: 675 ms

Fallback detection time: 5 min

Power on level: 100 %

Scenes

Scene 0 / Fallback: % Keep last defined dim-level

Scene 1: <input type="text" value="0"/> %	Scene 5: <input type="text" value="50"/> %	Scene 9: <input type="text" value="85"/> %
Scene 2: <input type="text" value="1"/> %	Scene 6: <input type="text" value="60"/> %	Scene 10: <input type="text" value="90"/> %
Scene 3: <input type="text" value="10"/> %	Scene 7: <input type="text" value="75"/> %	Scene 11: <input type="text" value="95"/> %
Scene 4: <input type="text" value="35"/> %	Scene 8: <input type="text" value="80"/> %	Scene 12: <input type="text" value="100"/> %

Description

Use this feature to configure the coded mains settings that are used when a coded mains command is received from a transmitter regarding the requested dimming scene for the driver.

Usage

Select the **Enable*** check box to use this feature and enable the coded mains interface on the driver. This feature has the following parameters:

- **Override***: If the check box is selected, that means the dim level can be overridden by other dimming interfaces.
- **Fade time**: Used to indicate how long it takes to perform a fade when switching scenes. The corresponding timings can be found in the driver specifications, and the corresponding time for the selected **Fade time** is also displayed next to the selection. In case **Fade time** is 0, the **Fast fade time** setting is used.
- **Fast fade time**: Used to indicate how long it takes to perform a fade when switching scenes. The corresponding timings can be found in the driver specifications, and the corresponding time for the selected **Fast fade time** is also displayed next to the selection. In case both **Fade time** and **Fast fade time** are 0, it means that there is no fade and the transition between scenes takes place immediately.
- **Fallback detection time**: Indicates the time after a driver power cycle that is used to wait for a valid coded mains command. In case no valid command is received within this time frame, the driver will switch to the fallback scene (Scene 0).
- **Power on level**: The light level applied when the driver is powered and before the first valid coded mains command is received.
- **Scenes**: Configurable dimming levels for a driver. A driver contains 13 scenes which can be configured individually between 0 and 100%. Scene 0 is the

fallback scene which can also be configured as 'keep the last defined dim-level'.

* **Note!** If the device supports interface selection, then this option can only be configured through the interface selection and the option will not be shown here.

12..15 Coded Mains Standalone Receiver

Product group

CONTROL

Control Output: Autodetect driver type
 DALI output
 1-10V output

 When 1-10V output is configured the control output cannot be set to another value. The device is no longer able to be discovered by MultiOne.

Description

Use this feature to configure the control output for the coded mains standalone receiver.

Usage

Select one of the options to set the desired control output.

12..16 Constant Light Output

Product group

HID, LED

12.3.16.1 HID version

The HID version of Constant Light Output (CLO) has two check boxes. Select the **Enable** check box to use the device's built-in Constant Light Output profile. Select the **Reset** check box to reset this feature, including resetting the lamp operating hours parameters. This is useful when replacing the HID lamp.

12.3.16.2 LED version

The Constant Light Output feature for LED devices will show the following window:

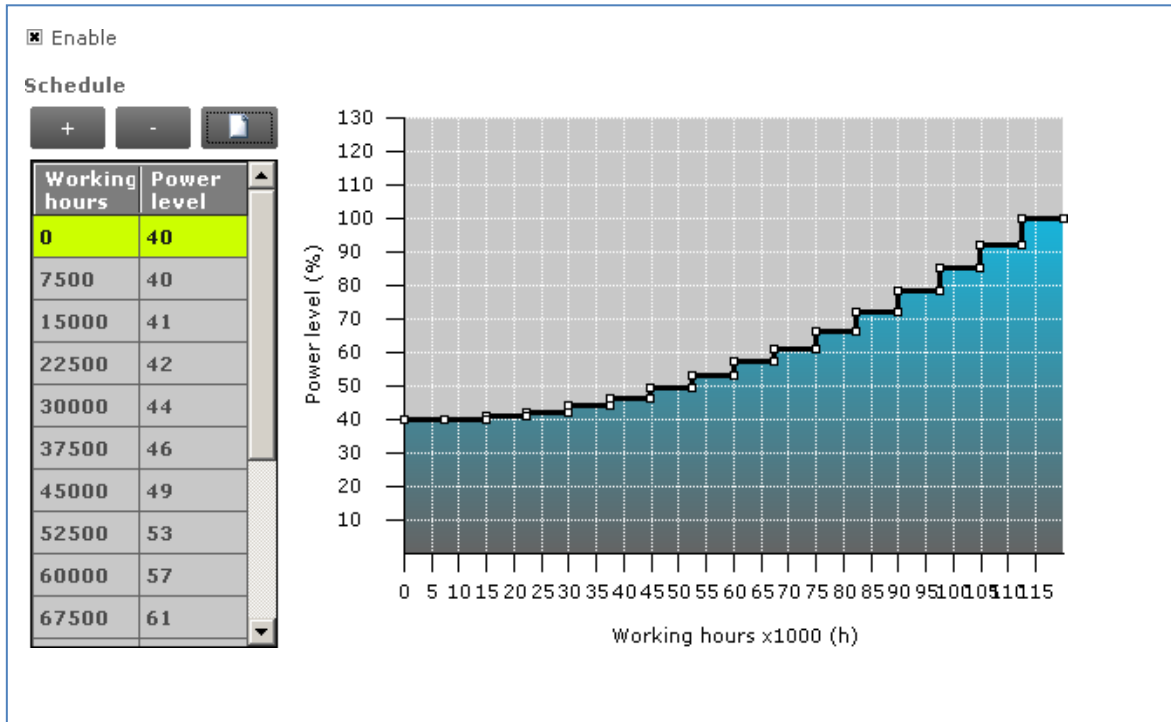

When a newer version of CLO is present in the device, the following window will be displayed:

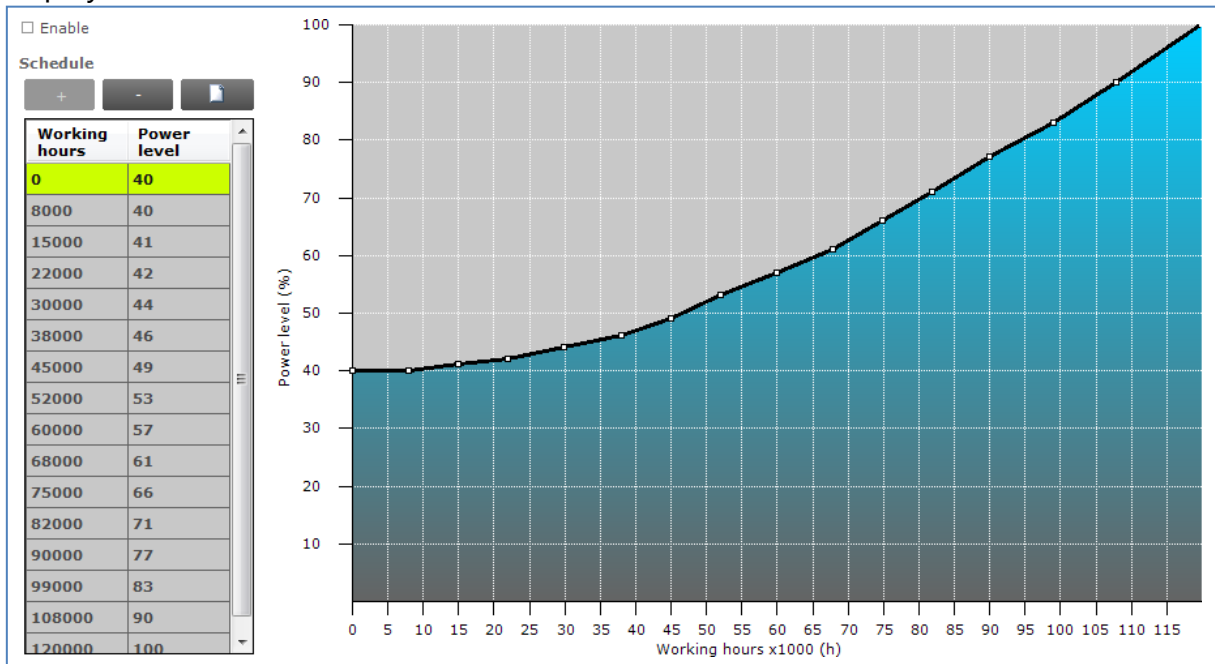

Description

The lumen output of a LED module usually decreases over its lifetime. To compensate, a schedule can be created that gradually increases the lamp's power level over time.

Usage

Select the **Enable** check box to use this feature. Click the **New** button to create a default schedule or click the **Plus** button to individually add scenes.

When creating a new schedule, in the dialog window that pops up you can either select an empty schedule, a default schedule or a custom schedule.

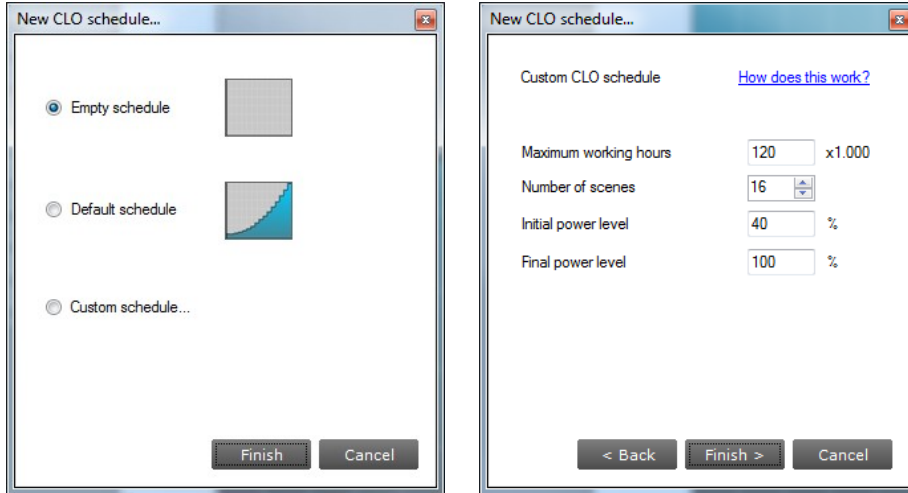

When selecting a custom schedule, you have to enter a number of parameters that will define the CLO schedule. These are:

- **Maximum working hours:** the largest number of working hours for which the CLO schedule is defined. This corresponds to the maximum value of the horizontal axis in the resulting CLO graph.
- **Number of scenes:** the number of scenes (bars in the graph, or in the newer version the points in the graph) into which the total number of burning hours is divided
- **Initial power level:** the power level that is the starting point at 0 burning hours
- **Final power level:** the power level at the end of the defined lifetime (the value given for maximum number of burning hours)

After clicking **Finish** a CLO schedule will be created using linear interpolation of the provided values.

Drag the points or the lines in the resulting graph to adjust the configuration. Alternatively, use the table to enter values directly. Single or multiple table rows can be removed by clicking the **Minus** button.

Note! The reliable use of Constant Light Output requires extensive LED specification assessment of life time behavior of LEDs.

12.3.16.3 LED version (simplified)

The simplified Constant Light Output feature will show the following window:

Enable

Maximum working hours: 64000 h

Initial power level: 80 %

Description

The lumen output of a LED module usually decreases over its lifetime. To compensate, a schedule can be created that gradually increases the lamp’s power level over time. By configuring the **Maximum working hours** and the **Initial power level** a linear schedule is defined which consists of 16 scenes. The first scene starts at 0h and at the specified initial power level. The last scene starts at the specified working hours and at 100% power level.

Usage

Select the **Enable** check box to use this feature. Use the **Maximum working hours** slider to configure the moment in time where the LED module will use the final power level.

Use the **Initial power level** slider to configure at which power level the LED module will initially start.

Note! The reliable use of Constant Light Output requires extensive LED specification assessment of life time behavior of LEDs.

12..17 Constant Light Output Multi-Channel

Product group

LED

Enable

Number of Channels

Channel 1

▶ Working hours	0	1000	2000	3000	4000	5000	6000
Power level	100	100	100	100	100	100	100

Description

Use the Constant Light Output Multi-Channel (CLOMC) feature to adjust the light output for each active channel.

Usage

Select the **Enable** check box to enable this feature.

Select the **Number of Channels** box to define the number of channels that will be available to adjust the light output. Modify the values in the table to achieve the desired schedule.

12..18 Correlated Color Temperature Dual Channel

Product group

LED

Min CCT value: K

Max CCT value: K

CCT value: K

Warm efficacy:

Cold efficacy:

Total number of CCT curve entries:

CCT curve value [K]	Warm [%]	Cold [%]
2700	100	0
2800	70	30
2900	30	70
3000	0	100
3100	100	0
3200	100	0
3300	100	0
3400	100	0
3500	100	0
5000	100	0

Description

Use the **Correlated Color Temperature Dual Channel** (CCTDC) to configure the light color of the Luminaire's LED module.

Usage

Use the **Min CCT value** slider to select the minimum permitted of **CCT value** of the luminaire's LED module. This value is represented in Kelvin.

Use the **Max CCT value** slider to select the maximum permitted of **CCT value** of the luminaire's LED module. This value is represented in Kelvin.

Use the **CCT value** slider to select the **CCT value** based in **Min CCT** value and **Max CCT** value set. This value is represented in Kelvin.

Use the **Warm efficacy** slider to select a value. This is the number of LEDs that radiate warm light in the LED module.

Use the **Cold efficacy** slider to select a value. This is the number of LEDs that radiate cold light in the LED module.

Select the **Total number of CCT curve entries** to construct the CCT curve that will be available to adjust the LED color. The entries should be in the ascending order of the color temperature.

Each CCT curve entry will represent color temperature with warm percentage and cold percentage.

12..19 Corridor Mode

Product group

FLUO, LED

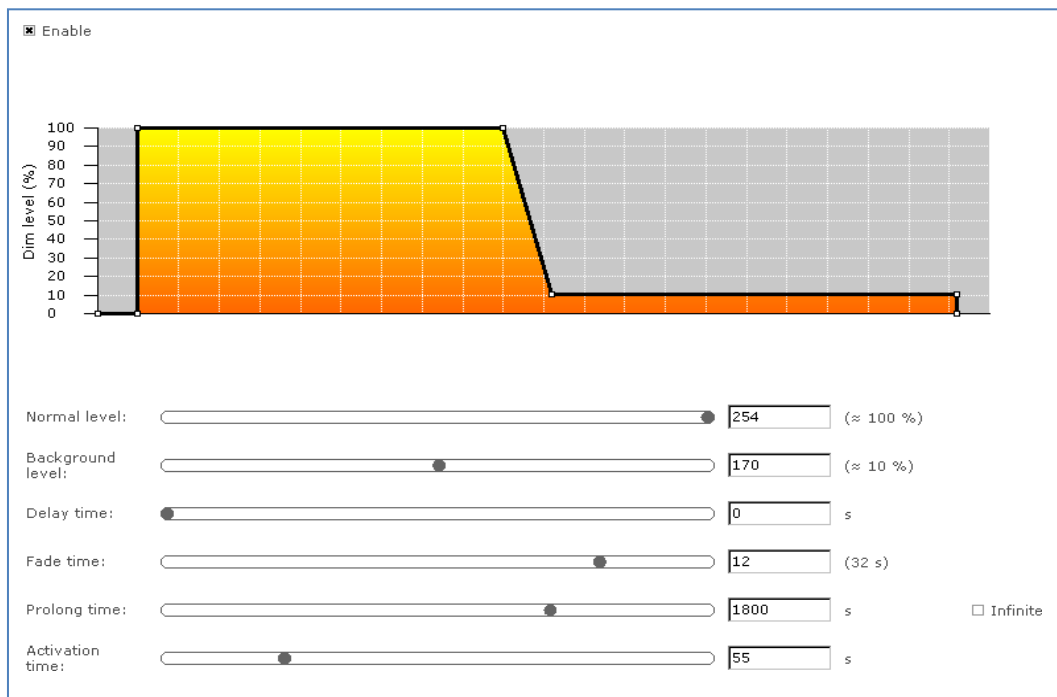

Description

Corridor Mode feature depends on Touch and Dim feature. The Corridor Mode feature adjusts the light to a defined level when a presence sensor detects a person. Corridor Mode can only be activated when the device is in Touch and Dim mode.

Usage

Select the **Enable** check box to use this feature. It is not possible to activate the driver via Touch and Dim, when this check box is not selected.

This feature has the following parameters:

- **Normal level:** Light level to be set when presence sensor detects activity

- **Background level:** Low light level to be set when no presence is detected after the fade time
- **Delay time:** The time from the moment the sensor has switched off and the moment the device will start to fade to background level
- **Fade time:** The time used to fade from normal level to background level
- **Prolong time:** When reaching background level, the time after which the device will be switched off
- **Activation time:** The time during which a mains signal must be detected, before the device will switch to Corridor Mode

Alternatively to using the sliders, some lines and points in the graph can be dragged to adjust the configuration.

12..20 DALI 102

Product group

LED

Power on level:	<input type="range" value="254"/>	254	(≈100 %)	<input type="checkbox"/> Do nothing			
System failure level:	<input type="range" value="255"/>	255	(≈100 %)	<input checked="" type="checkbox"/> Do nothing			
Min level:	<input type="range" value="84"/>	84	(≈1 %)				
Max level:	<input type="range" value="129"/>	129	(≈3 %)				
Fade rate:	<input type="text" value="7"/>						
Fade time:	<input type="text" value="1"/>						
Extended fade time based:	<input type="text" value="1"/>						
Extended fade time multiplier:	<input type="text" value="1"/>						
Operating mode:	<input type="text" value="128"/>			*Operating mode can either be 0 or between 128 and 255			
Short address:	<input type="text" value="62"/>			*Short address can either be 255 or between 0 and 63			
Scenes							
Scene 0:	<input type="text" value="255"/>	Scene 4:	<input type="text" value="255"/>	Scene 8:	<input type="text" value="255"/>	Scene 12:	<input type="text" value="255"/>
Scene 1:	<input type="text" value="255"/>	Scene 5:	<input type="text" value="255"/>	Scene 9:	<input type="text" value="255"/>	Scene 13:	<input type="text" value="255"/>
Scene 2:	<input type="text" value="255"/>	Scene 6:	<input type="text" value="255"/>	Scene 10:	<input type="text" value="255"/>	Scene 14:	<input type="text" value="255"/>
Scene 3:	<input type="text" value="255"/>	Scene 7:	<input type="text" value="255"/>	Scene 11:	<input type="text" value="255"/>	Scene 15:	<input type="text" value="255"/>
Groups							
<input type="checkbox"/> Group 0	<input type="checkbox"/> Group 4	<input type="checkbox"/> Group 8	<input type="checkbox"/> Group 12				
<input type="checkbox"/> Group 1	<input type="checkbox"/> Group 5	<input type="checkbox"/> Group 9	<input type="checkbox"/> Group 13				
<input type="checkbox"/> Group 2	<input type="checkbox"/> Group 6	<input checked="" type="checkbox"/> Group 10	<input type="checkbox"/> Group 14				
<input type="checkbox"/> Group 3	<input type="checkbox"/> Group 7	<input type="checkbox"/> Group 11	<input type="checkbox"/> Group 15				

Description

Use the DALI 102 feature to configure DALI settings via **Device features** tab instead of **Commands tab**.

Usage

This feature has the following parameters:

- **Power on level:** Light level applied when driver is powered and DALI supply is connected, when **do nothing** is selected, the driver will not act upon power on.
- **System failure level:** Light level applied when driver is powered and no DALI supply is connected, when **do nothing** is selected, the driver will not act upon system failure
- **Min level:** Minimum light level of the driver, this cannot be set lower than the physical minimum level of the driver and cannot be set higher than the **Max level**
- **Max level:** Maximum light level of the driver, this cannot be set lower than the **Min level**
- **Fade rate:** Number of fade steps
- **Fade time:** This is used to indicate how long it takes to perform fade
- **Extended fade time base:** Used to calculate extended fade time
- **Extended fade time multiplier:** Used to calculate extended fade time
- **Operating mode:** Operating mode of the driver
- **Short address:** Short address of the driver
- **Scenes:** A configurable preset level for the driver, a driver contains 16 scenes for which can be configured individually
- **Groups:** Defines in which groups the driver is located

12..21 DALI 202

Product group

LED

Emergency level:	<input type="range" value="254"/>	<input type="text" value="254"/>	(≈100 %)	<input type="checkbox"/> Do nothing
Prolong time:	<input type="range" value="0"/>	<input type="text" value="0"/>	min	
Function test interval:	<input type="range" value="7"/>	<input type="text" value="7"/>	days	
Duration test interval:	<input type="range" value="52"/>	<input type="text" value="52"/>	weeks	
Test execution timeout:	<input type="range" value="7"/>	<input type="text" value="7"/>	days	
Lamp emergency time:	0 hours			
Lamp total operation time:	0 hours			

Description

Use the DALI 202 feature to configure DALI settings via **Device features** tab instead of **Commands tab**.

Usage

This feature has the following parameters:

- **Emergency level:** Arc power level during emergency, when **do nothing** is selected, the driver will not act upon emergency level
- **Prolong time:** Duration of extended emergency mode
- **Function test interval:** Interval between function tests
- **Duration test interval:** Interval between duration tests
- **Test execution timeout:** Timeout for a pending function or duration test
- **Lamp emergency time:** Accumulated lamp on time while powered by battery
- **Lamp total operation time:** Accumulated lamp on time

12..22 DALI Power Supply

Product group

LED

 Enable

Description

Use the DALI Power Supply (DALI PSU) feature to enable the device so it will deliver the power supply for DALI communication by itself.

Usage

Select the **Enable** check box to use this feature.

12..23 Daylight override / Daylight switching

Product group

CONTROL

 Enable daylight dependent override
 Enable daylight dependent switching

Description

Use the DLO/DLS feature to configure the daylight dependent settings for the device.

Usage

This feature has the following parameters:

- **Enable daylight dependent override:** When the **Enable daylight dependent override** check box is selected, the lights remain off in case occupancy is detected.
- **Enable daylight dependent switching:** Select the **Enable daylight dependent switching** check box to switch the light off in case sufficient daylight is available.

12..24 DC Emergency

Product group

FLUO, LED

Enable

Allow dimming

Emergency level:

(≈ 70 %)

Description

This feature is used together with a DC central battery system. The device will dim to a specific level, as soon as a DC voltage is detected at the mains input instead of an AC voltage on the mains input of the device. The dimming of the lamps can either be enabled or disabled during this DC Emergency operation.

Usage

Select the **Enable** check box to use this feature. Use the slider or the text field to select a value. The value represents the arc power level when in DC Emergency mode (the label on the right gives the approximate light level percentage). Select the **Allow dimming** check box to allow dimming when in DC Emergency mode.

12..25 Device Info

Product group

LED

Device model:

Device label:

Date/Order code:

LED reference bin code:

LED colour code:

LED bin code:

Description

Use the Device Info feature to get or set the device information which may be luminaire specific.

Usage

Select the Device Info feature tab to read or write the device information.

12.26 DiiA specification DALI Part 253 - Luminaire Maintenance

Product group

CONTROL

Rated median useful life of luminaire:	<input type="range"/>	<input type="text" value="233000"/>	h
Internal control gear reference temperature:	<input type="range"/>	<input type="text" value="0"/>	°C
Rated median useful light source starts:	<input type="range"/>	<input type="text" value="594700"/>	

Description

This feature provides an interface for storing information to enable predictive maintenance of a device.

Usage

This feature has the following parameters:

- **Rated median useful life of luminaire:** Use the slider or the text field to select a value. The specified value represents the rated median useful life time of the luminaire in hours.
- **Internal control gear reference temperature:** Use the slider or the text field to select a value. The specified value represents the internal control gear reference temperature in degrees Celsius.
- **Rated median useful light source starts:** Use the slider or the text field to select a value. The specified value represents the rated median useful light source starts of the luminaire.

12.27 Dimming Interface

Product group

LED

Interface	<input type="text" value="DALI"/>	Dimming curve
		<input checked="" type="radio"/> Logarithmic
		<input type="radio"/> Linear

Description

Use the Dimming Interface feature to select the dimming interface for the device. The actual options are depending on the device model:

- **1-10 V**
- **DALI**
- **Dynadimmer**
- **No dimming**
- **AmpDim**
- **LineSwitch**
- **Coded Mains**

When **DALI** has been selected, an additional setting appears with which the dimming behavior can be set. Options are **Logarithmic** and **Linear** dimming curves.

Usage

Use Dimming Interface to select the desired dimming interface.

Product group

FLUO, LED

A screenshot of a user interface element. It consists of a rectangular box with a light gray background. On the left side, the word "Interface" is written in a small, dark font. To the right of "Interface" is a dropdown menu. The dropdown menu is currently open, showing the text "Automatic selection" in a light gray font. A small downward-pointing arrow is visible on the right side of the dropdown menu.

Description

Use the Dimming Interface feature to select the dimming interface for the device.

Usage

The available dimming interfaces are stored in the device and therefore need to be read out. When the interfaces are found it will be possible to select **Automatic selection** (enable all interfaces), **No dimming** (disable all interfaces) or a **single** interface.

Product group

LED

A screenshot of a user interface element. It consists of a rectangular box with a light gray background. On the left side, the word "Interface" is written in a small, dark font. To the right of "Interface" is a dropdown menu. The dropdown menu is currently open, showing the text "Dynadimmer" in a light gray font. To the right of the dropdown menu, the text "Can be overridden by" is written in a small, dark font. Below this text, there are two checkboxes. The first checkbox is checked and is followed by the text "1-10V". The second checkbox is unchecked and is followed by the text "LineSwitch".

Description

Use the Dimming Interface feature to enable dimming interfaces for the device.

Usage

The available dimming interfaces are stored in the device and therefore need to be read out. When the interfaces are found it will be possible to select and enable the main interface. Some interfaces have the possibility to be overridden by another

interface. If that's the case the **Can be overridden by** part will show the other possible interfaces that can be enabled together with the main dimming interface.

Note! All selected interfaces (both the main interface and the selected **Can be overridden by** interfaces) will have their **Enable** value set to true if present. Else the value is set to false.

Note! The **Override** for the **main interface** is automatically set to true if any **Can be overridden by** interface is selected. Else the value is set to false. The **Override** value for all other interfaces (if present) are set to false even if the main interface does not support any **Can be overridden by** interfaces.

12..28 Driver addressing

Product group

LED

DMX address:	<input type="text" value="1"/>
<input checked="" type="checkbox"/> Enable	
Group size:	<input type="text" value="2"/>
Group address:	<input type="text" value="1"/>
DMX Personality:	<input type="text" value="Personality 1"/>

Description

Use the Driver addressing feature to determine the DMX settings for the device.

Usage

- **DMX address:** DMX address
- **Enable:** When the check box is cleared the grouping feature within one DMX address is not used.
- **Group size:** Number of devices that operate within one group, all responding to the same DMX address.
- **Group address:** Device number within the group of devices that respond to the same address.
- **DMX Personality:** RDM Personality.

12..29 Driver Temperature Limit

Product group

LED

Enable
 Start dim: 25 °C
 Stop dim: 75 °C
 Shut Down: 95 °C Disabled
 Dim level: 5 %

Description

Use the Driver Temperature Limit feature to determine the temperature protection settings for the device.

Usage

Select the **Enable** check box to use this feature. Use the sliders to changes the values for this feature.

- **Enable:** Select the **Enable** check box to use this feature.
- **Start dim:** Set the temperature at which dimming start.
- **Stop dim:** Set the temperature at which the dimming stops.
- **Shut down:** Set the temperature at which the dim level will be set to zero. When selecting the N/A checkbox, the shutdown temperature is not applied
- **Dim level:** Set the dim level for the Stop dim temperature.

12..30 Driver Temperature Limit for Lock

Product group

LED

Driver Temperature Limit Lock

Enable

Note: The settings of the Driver Temperature Limit must be configured in the DTL tab.

Warning: This setting enables a lock function on the DTL. When the shutdown temperature is reached the driver will lock in the standby state and cannot be turned on again by the end user. Reset of the lock state can only be performed with MultiOne

Driver Temperature Limit Lock

Driver Temperature Limit Unlock

Dtl Lock Status: Unlocked

Unlock DTL

Note: When the driver lock state is Locked, the driver is locked in standby mode because Driver Temperature Limit (DTL) was exceeded. The driver can be unlocked in this screen.

Warning: The condition that triggered the protection of the driver (e.g. high temperature) should also be removed.

Driver Temperature Limit Unlock

Description

The driver supports this feature, must be locked in shut-down state after the thermal limit of the product has been reached.

Usage

Next to the regular DTL screen there is a separate tab for the lock feature. Select the **Enable** check box to use this feature.

- **Enable:** Select **Enable** to Enable/disable lock driver feature.
- **DTL Lock Driver:** Feature to lock the driver when lamp is shut down due to too high temperature.
- **DTL Unlock Driver:** Feature to unlock the driver by maintenance service if it was locked.

12..31 Dwell Time

Product group

CONTROL

Activated

Enabled

Description

Use the Dwell Time feature to postpone present detection for a certain time.

Usage

This feature has the following parameters:

- **Activated:** Select the **Activated** check box to activate the feature.
- **Enabled:** Select the **Enabled** check box to turn Dwell Time on.

12..32 Dynadimmer

Product group

HID, LED

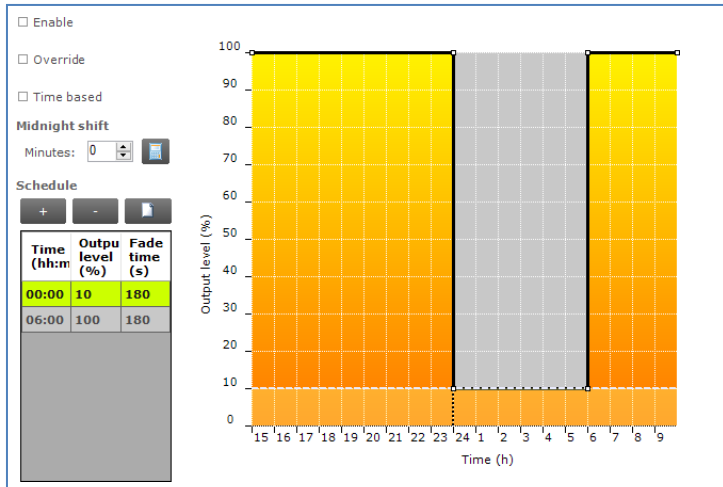

Description

Use Dynadimmer to create a dynamic dimming schedule over a period of time.

Usage

Select the **Enable*** check box to use this feature. This feature has a number of options, depending on the device model:

- **Time based:** switch between absolute and relative time schedules. When the **Time based** check box is cleared, the Dynadimmer schedule will use its automatically learned midnight point as a reference for timekeeping. When the **Time based** check box is selected, the reference point is the moment when the mains are switched on. Selecting the **Time based** check box changes the graph and removes its dotted midnight line. Note that not all devices support Time based Dynadimmer.
- **Midnight shift:** the midnight point depends on the geographical location. Enter the midnight shift in minutes or use the midnight shift calculation window to automatically adjust the midnight point by the specified offset. Use the calculation button to either manually provide latitude and longitude coordinates or to choose a predefined location. The midnight shift option is unavailable when the **Time based** check box has been selected.

The midnight shift calculation dialog window looks as follows:

Calculate midnight shift

From coordinates

Latitude deg min s N S

Longitude deg min s E W

Time zone Daylight saving

Calculated midnight shift (min): 0

OK Cancel

- **Latitude:** the latitude of the location in degrees, minutes and seconds. The value that represents the degrees cannot be negative.
- **N-S:** the direction for latitude of the location. The user can either select North or South value.
- **Longitude:** the longitude of the location in degrees, minutes and seconds. The value that represents the degrees cannot be negative.
- **E-W:** the direction for longitude of the location. The user can either select East or West value.
- **Time zone:** the time zone of the location. For GMT+1 enter 1, for GMT-1 enter -1, and so on.
- **Daylight saving:** indication whether daylight saving should be dealt with or not.

Click **OK** to save result of your calculation as the new midnight shift. Note that clicking **OK** is not directly saving your data to the driver. To save midnight shift to a driver you will have to write the whole feature.

Click the **New** button to create a default schedule or click the **Plus** button to add scenes individually. Drag the points or the lines in the graph to create the desired configuration. Alternatively, use the table to enter values directly. Remove single or multiple table rows by clicking the **Minus** button.

Note! The device will follow the dimming schedule. When the output level in the dimming schedule is below the physical min level of the selected lamp, the physical min level will be used. However, some devices are also capable to switch off during the dimming schedule, if a scene was configured at 0 %. The physical min level of the selected lamp is indicated by the gray-dotted line in the graph.

Note! This feature can contain the **override** check box in some cases. If the check box is selected, that means the dim level can be overridden by other dimming interfaces.

* **Note!** If the device supports interface selection then this feature can only be enabled through the interface selection and the enable will not be shown here.

12.3.31.1 *Physical min level*

In order to see the correct physical min level of a lamp after Lamp Selection do not forget to switch the driver off for a few seconds. After switching it on again the selected lamp is activated. To see the physical min level of the selected lamp in the graph, click **Read** on the toolbar.

12.3.31.2 *Location or custom location*

For some device models, only the midnight point offset is stored in the device and **NOT** the (custom) location. In those cases the location information and the custom location is only used to calculate the midnight point offset. After reading out the device, MultiOne tries to match the midnight point offset with a location. In case the midnight point offset does not match to a location or the midnight point offset matches multiple locations, MultiOne will show "No location".

For a technical description of the characteristics of the device model, like constraints and limitations, please refer to [Device-specific technical description](#).

12.33 **End Of Life indication**

Product group

LED



The image shows a user interface for the 'End Of Life indication' feature. It includes a checked checkbox labeled 'Enable'. Below the checkbox is a horizontal slider with a dark circular knob on the left side. To the right of the slider is a text input field containing the number '0', followed by a small 'h' representing hours.

Description

Use this feature to warn the user at the end of the guaranteed lifespan of the LED module. Once the end of guaranteed life is reached, the device will flash the lamp for 5 seconds and then continue normal operation. LED flashing will happen every time at startup once the device's working hours have exceeded the number of hours specified as End Of Life. This feature uses the same burning hours counter as the Light Source Operating Hours and Constant Light Output features.

Usage

Select the **Enable** check box to use this feature. Use the slider or the text field to select a value. The value represents the guaranteed lifetime in hours.

12.34 FCC

Product group

CONTROL

Enable

Test id: 2: Unmodulated test

ZigBee channel: Channel 25

Attenuation: 177

Light level: 110 (≈ 2 %)

Description

Use this feature to enter the settings for the FCC test, and to enable the FCC test.

Usage

Select the **Enable** check box to use this feature. The feature has the following parameters:

- **Test id:** use the drop down box to select the test.
- **ZigBee channel:** use the drop down box to select the ZigBee channel for the test.
- **Attenuation:** use the slider or the text field to select a value. The value represents the attenuation for the test.
- **Light level:** use the slider or the text field to select a value. The value represents the light level for the test.

12..35 FccRed

Product group

Control

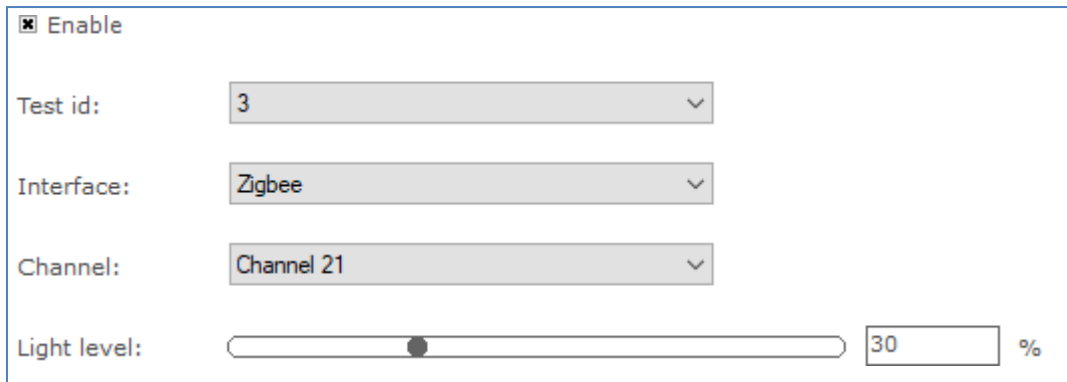

Enable

Test id: 3

Interface: Zigbee

Channel: Channel 21

Light level: 30 %

Description

Use this feature to put the device in a specific mode (with a constant carrier on the wireless interface) in order to be able to perform the necessary measurements for RED and FCC approbation.

Usage

Select the **Enable** check box to use this feature. The feature has the following parameters:

- **Test id:** use the drop down box to select the test.
- **Interface:** use the drop down to select the desired interface.
- **Channel:** use the drop down to select the channel on which the test will be executed. Depending on the selected interface a number of different channels are available.
- **Light level:** use the slider or the text field to select a value. The value represents the light level for the test.

12.36 FlexTune

Product group

LED

The screenshot displays the 'LED string configuration' interface. It is divided into three main sections:

- LED string configuration:** Includes a 'Configuration by' dropdown set to 'X,Y'. Below are input fields for 'Cool LED' (X: 0.31, Y: 0.327, Tc: 6671 K) and 'Warm LED' (X: 0.457, Y: 0.408, Tc: 2712 K). There are also fields for 'Rated lumen' (2200 Lm @ 308 mA) and 'Rated current' (2040 Lm @ 308 mA).
- Light level configuration:** Features a 'Light output over Tc range' dropdown set to 'Constant'. It shows sliders and input fields for 'Cool LED' (AOC: 4636 Lm @ 649 mA) and 'Warm LED' (AOC: 4636 Lm @ 700 mA).
- Additional color configuration:** Contains sliders and input fields for 'Power on Tc' (5294 K), 'System failure Tc' (3500 K), 'Tc coolest' (6182 K), 'Tc warmest' (5193 K), and 'Tc offset (+/-)' (0 K).

Description

The FlexTune feature allows the user to alter the white balance.

Usage

LED string configuration

The user can configure the white balance for both the cool and warm LED using two different configuration methods:

- **X, Y**, the user enters the coordinates for both the X and Y.
- **Tc**, the user enters the Kelvin value for both the cool and warm LED. When using Tc then the X and Y values are estimated which may cause lower Tc accuracy.

The **Rated Lumen** and **Rated Current** are entered in the textbox which is used to calculate the efficacy for the cool and warm LED.

Light level configuration

Depending on the supported options the user can select two modes to configure the AOC for the cool and warm LED.

- **Constant**, allows only the cool LED to be configured.
- **Flexible**, allows for both the cool and warm LED to be configured.

The AOC values for the cool and warm LED can be configured using either the slider or entering a value into the textbox. The min and max values for the AOC fields are calculated from the values entered in the **LED string configuration** section.

Additional color configuration

The additional color configuration allows to set extra parameters for the FlexTune feature.

- **Power on Tc**, sets the color for Tc when powered on.
- **Tc coolest**, the coolest Tc value that can be reached by DALI commands.
- **Tc warmest**, the warmest Tc value that can be reached by DALI commands.
- **Tc offset**, allows a positive or negative Tc offset in Kelvin. This may be used to offset for color shifts caused by secondary optics, light guides or external influences.

12..37 Field Task Tuning

Product group

CONTROL



Description

Use this feature in combination with the **EasySense** so the light output can be limited according to the selected value.

Usage

The field task tuning level is intended as maximum light level (clip level) of the luminaire. The light output shall not be scaled against the field task tuning level. If this level is below 100%, not the whole DALI range will be used. This is acceptable, since when a lot of daylight is present also a small part of the range is used.

12..38 Field Task Tuning / Occupancy Sensing / Daylight Harvesting

Product group

CONTROL

Occupancy

Daylight based control

LED indicator

Occupancy mode:

Field task level: %

Eco ON level: %

Background light level: %

Hold time: min

Prolong time: min Infinite

Grace fading: s

Description

This is a combined feature of **Field Task Tuning** and **Occupancy Sensing/ Daylight Harvesting**, use this feature to ensure the correct functioning of the **EasySense**.

Usage

The **Field task level**, **Background light level** and **ECO ON level** are related to each other. The **Background light level** is the light level at which the lights will glow when no occupancy is detected, and it should be lower or equal to the **Eco ON level**. The **Eco ON level** should be lower or equal to the **Field task level** and it can be overruled with a switch. The **Field task level** is intended as maximum light level (clip level) of the luminaire.

For the usage of all the other parameters, please refer to **Occupancy Sensing/ Daylight Harvesting** feature.

12..39 Lamp Burn-in

Product group

FLUO

Enable

Burn-in level : Use default

250 (≈ 90 %)

Burn-in time: Use default

6000 min

Description

Lamp Burn-in prevents dimming below a predefined level in the first hours of a lamp's life. This is to ensure that the lamp will be properly "burned in" before dimming.

Usage

Select the **Enable** check box to use this feature. This feature has of two parameters:

- **Burn-in level:** use the slider or the text field to select a value. The value represents the maximum arc power level for dimming (the label on the right gives the approximate light level in percent). Alternatively, select the **Use default** check box to use the default value.
- **Burn-in time:** use the slider or the text field to select a value. The value represents the time in minutes during which the burn-in level is active. Alternatively, select the **Use default** check box to use the default value.

12..40 Lamp Selection

Product group

HID, FLUO

Selection

Description

Use the Lamp Selection feature to select the lamp type that is connected to the device. Options depend on the device model.

Usage

Use **Selection** to select the lamp type. Note that this feature has to be read first in order for the options to become available. To read the feature configuration, click **Read** on the toolbar.

Note! After selecting a different lamp, it is necessary to switch the driver off for a few seconds. After switching is on again the selected lamp is activated.

12..41 Light Source Operating Hours

Product group

LED

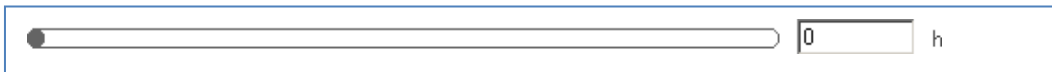

Description

Use this feature to manually set or reset the number of operating hours for the LED module. This is useful when replacing the LED module, thereby resetting features like Constant Light Output and End Of Life indication.

Usage

Use the slider or the text field to select a value. The value represents the number of operating hours.

12..42 LineSwitch

Product group

HID, LED

High V level:	<input type="range" value="50"/>	<input type="text" value="50"/> %
Low V level:	<input type="range" value="100"/>	<input type="text" value="100"/> %
Fade up time:	<input type="range" value="0"/>	<input type="text" value="0"/> s
Switch off delay time:	<input type="range" value="0"/>	<input type="text" value="0"/> s
Fade down time:	<input type="range" value="0"/>	<input type="text" value="0"/> s
Enable level 2:	<input type="checkbox"/>	
Delay for level 2:	<input type="range" value="0"/>	<input type="text" value="0"/> min
Level 2:	<input type="range" value="0"/>	<input type="text" value="0"/> %

Note 1: Low V = Open and High V = Line on LineSwitch terminal.

Note 2: When LineSwitch is enabled to override DynaDimmer, the level with the highest percentage is the active (override) level, this could be either High V or Low V level. The level with the lower percentage is ignored by the active DynaDimmer.

Description

This feature provides an interface for easy dimming via pilot-line or external sensor (presence) of a group of lamps. Dimming to desired level can be controlled by

applying a 230V between the DALI inputs. The fade times can also be set using the fade on-, fade off and switch off delay time.

Usage

Select the **Enable*** check box to use this feature. This feature has the following parameters:

- **High V level:** Use the slider or the text field to select a value. The value represents the light level to be set when high voltage is detected on the mains.
- **Low V level:** Use the slider or the text field to select a value. The value represents light level to be set when low voltage is detected on the mains.
- **Fade up time:** Use the slider or the text field to select a value. The value represents the fade on time to be used.
- **Switch off delay time:** Use the slider or the text field to select a value. The value represents the switch off delay time to be used.
- **Fade down time:** Use the slider or the text field to select a value. The value represents the fade off time to be used.

In case the device supports Level 2 settings, these will be visible on the UI. Select the **Enabled Level 2**** check box to use the second dim level function. This option has the following parameters:

- **Delay for Level 2:** Use the slider or the text field to select a value. The value represents the delay time to be used in activation of the second dim level.
- **Level 2:** Use the slider or the text field to select a value. The value represents the light level to be set when the second dim level is active.

When the [Switch Off delay time] is programmed in combination with the second level, the dim level during the switch off delay is the active level (depending on the polarity this is [High V level] or [Low V level]). The [Delay for Level 2] will start after the [Switch Off delay time] has expired.

* **Note!** If the device supports interface selection then this feature can only be enabled through the interface selection and the enable will not be shown here.

** **Note!** When the LineSwitch function is disabled, the enabled second level function is implicitly also not effective. The second level uses the same fade up and fade down times as the High V and Low V levels.

12.43 Load Fault Indicator Thresholds

Product group

CONTROL

Lamp failure power level:

W

Minimum Driver Dim Level:

%

Note: The "Lamp failure power level" is the output power at which the SR Bridge will report a lamp failure. It is recommended to choose a power level of 90% of the total load.

Description

To allow the SR Bridge to set the DALI lamp failure detection properly, the SR Bridge must be configurable to set a power limit that corresponds to the lamp failure level. This involves setting the correct maximum power of all downstream drivers combined and the minimum detection dimlevel for which the SR Bridge will not update the lamp failure status.

Usage

This feature has the following parameters:

- **Lamp failure power level:** Use the slider or the text field to select a value. This value corresponds to the maximum power of all downstream drivers combined.
- **Minimum Driver Dim Level:** Use the slider or text field to select a value. This value corresponds to the minimum detection dimlevel for which the SR Bridge will not update the lamp failure status.

12..44 Logical Signal Input

Product group

LED

Enabled

Mode: Occupancy sensor

Active dim level:
90.55
%

Inactive dim level:
50
%

Polarity:

Active when LSI input is Low

Active when LSI input is High

Fade on time:
10
s

Hold off delay:
16220
s

Fade off time:
40
s

Switch off delay:
40000
s

Enable output off

Description

Use this feature to configure an additional input signal that can be used to connect sensors (e.g. occupancy or photo sensors) to a driver without the need for a sophisticated OLC.

Usage

Select the **Enable** check box to use this feature. This feature has the following parameters:

- **Mode:** Use the drop down box to select the sensor connected to the logical signal input.
- **Active dim level:** Use the slider or the text field to select a value. The specified value represents the active dim level in percent. The active dim level is the dim level which will be used when the input voltage level is equal to the selected polarity, i.e. the input signal is active.
- **Inactive dim level:** Use the slider or the text field to select a value. The specified value represents the inactive dim level in percent. The inactive dim level is the dim level which will be used when the input voltage level is opposite to the selected polarity, i.e. the input signal is inactive.
- **Polarity:** Use the radio buttons to select the polarity of the input voltage on which LSI should be active.
- **Fade on time:** Use the slider or the text field to select a value. The specified value represents the fade on time in seconds. The fade on

time is the time used to softly fade from the inactive dim level to the active dim level from the moment the LSI state becomes active.

- **Hold off delay:** Use the slider or the text field to select a value. The specified value represents the hold off delay in seconds. The hold off delay is the applied delay when LSI switches from active to inactive before the fade off starts.
- **Fade off time:** Use the slider or the text field to select a value. The specified value represents the fade off time in seconds. The fade off time is the time used to softly fade from the active dim level to the inactive dim level from the moment the LSI state becomes inactive and the hold off delay has passed.
- **Switch off delay:** Use the slider or the text field to select a value. The specified value represents the switch off delay in seconds. The switch off delay is the applied delay when the fade off time is expired and Enable output off is enabled.
- **Enable output off:** Use the check box to enable or disable switching the output.

The schematic below gives a visual representation of the usage of the different parameters.

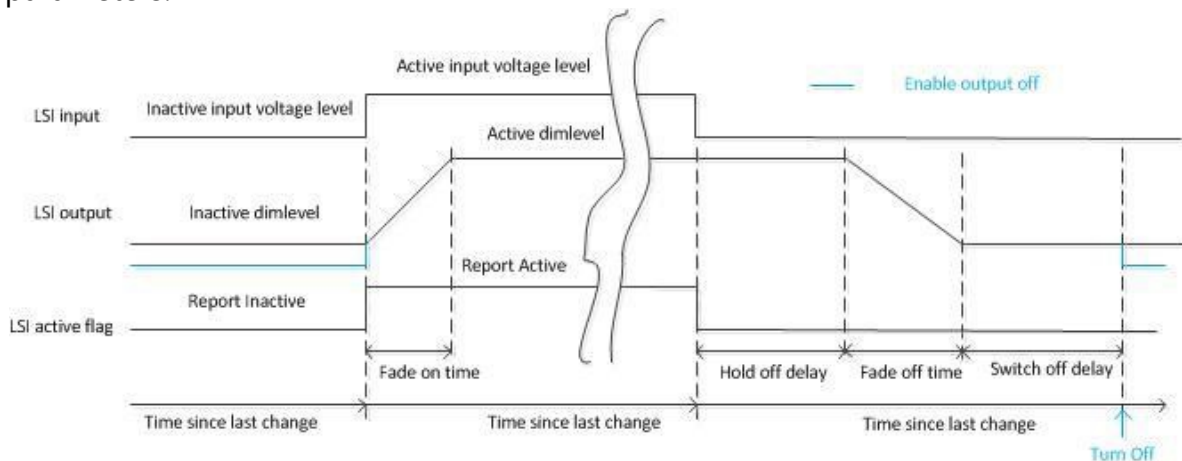

12..45 Luminaire (Fixture) Information

Product group

LED

Content format ID:	Unformatted content	<input type="checkbox"/> Use device UID
GTIN (EAN13):	9999999999999	
Identification number:	18446744073709551615	
Additional info (101):	Some extra information	

Description

Luminaire (Fixture) Information contains three mandatory fields: the **Content format ID** to select the content format, the **GTIN** and the **Identification number** of the luminaire which are used as traceability information for OEMs.

Depending on the selected **Content format ID**, additional fields are available for storing more detailed information. For example, when selecting 'Unformatted content' as **Content format ID**, the **Additional info** field can be used for additional control gear information.

Usage

- **Content format ID:** Select the format in which to store the information. Additional fields to fill are shown on the UI (or in some cases only their maximum allowed length change) when changing the **Content format ID**.
- **GTIN:** Use the textbox to change the value. The **GTIN** always contains 13 digits: if the value given by the user is less than 13 digits, leading 0s will be added till the number reach 13 digits.
- **Identification number:** Use the textbox to change the value. The **Identification number** can have up till 15 digits, however, the value given by the user shall not exceed the value shown above in the picture.
- Select **Use device UID** checkbox to enable copy identification number at power-on. If the checkbox is enabled, the field **Identification number** is not editable.

Additional fields are available for storing more detailed information.

Note! If the field **Use device UID** is changed, the user will need restart the device.

12..46 Luminaire Production Test

Product group

CONTROL

Test id (0-31):	0	▼
Select the test id. Please read the referring document of the product, which includes the description and content of the test id.		
Execution state:	0: Idle	▼
Test result:	0: Not started	

Description

This feature provides an interface to execute specific tests and validate the result.

Usage

- **Test id (0-31):** Use the drop down box to select the test id to be executed.
- **Execution state:** Use the drop down box to select the execution state.

- **Idle:** No test to execute.
- **Start:** Execute test at power up or when new test is selected
- **Test result:** Result of the test.
 - **Not started:** No test executed.
 - **Passed:** Test executed successfully, test not started at power up.
 - **Failed:** Test failed and will be started again at next power up.
 - **Unknown test id:** Test not implemented, not started at next power up.

12..47 LumiStep

Product group

LED

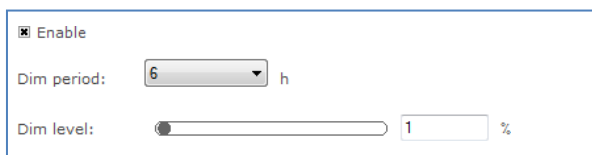

Description

This feature provides a simplified version of Dynadimmer.

Usage

Select the **Enable*** check box to use this feature. This feature has the following parameters:

- **Dim period:** Use the drop down box to select the wanted dim period. This is the time period the dim level will be used.
- **Dim level:** Use the slider or the text field to select a value. The value represents the dim level in percent. The dim level will be used during the dim period.

* **Note!** If the device supports interface selection then this feature can only be enabled through the interface selection and the enable will not be shown here.

12..48 Min Dim Level

Product group

LED



The image shows a user interface for setting the minimum dim level of an LED device. It consists of a blue-bordered box containing the following elements: a checked checkbox labeled "Enable", a horizontal slider with a dark grey knob positioned at the far left, and a text input field containing the number "1" followed by a percentage sign "%".

Description

This feature provides an interface for setting the min dim level of a device.

Usage

Select the **Enable** check box to use this feature. Use the slider or the text field to select a value. The value represents the min dim level in percentage.

12..49 Motor Control

Product group

CONTROL

Enable Tilt

Minimum tilt range °

Maximum tilt range °

Tilt full range steps steps

Minimum tilt speed °/s

Maximum tilt speed °/s

Current tilt speed °/s

Enable Pan

Minimum pan range °

Maximum pan range °

Pan full range steps steps

Minimum pan speed °/s

Maximum pan speed °/s

Current pan speed °/s

Enable Zoom

Minimum zoom range °

Maximum zoom range °

Zoom full range steps steps

Minimum zoom speed °/s

Maximum zoom speed °/s

Current zoom speed °/s

Description

This feature provides an interface for setting the motor control for tilt, pan and zoom functions of a device.

Usage

For each functions it is possible to configure the following parameters:

- Select the **Enable Tilt/Pan/Zoom** check box to use tilt/pan/zoom functionality.
- **Minimum tilt/pan/zoom range:** Use the slider or the text fields to select a value. The specified value represents the minimum range for tilt/pan/zoom function in degrees.
- **Maximum tilt/pan/zoom range:** Use the slider or the text fields to select a value. The specified value represents the maximum range for tilt/pan/zoom function in degrees.

- **Tilt/Pan/Zoom full range steps:** Use the slider or the text fields to select a value. The specified value represents the full range steps for tilt/pan/zoom function in number of steps.
- **Minimum tilt/pan/zoom speed:** Use the drop down box to select the minimum speed for tilt/pan/zoom function.
- **Maximum tilt/pan/zoom speed:** Use the drop down box to select the maximum speed for tilt/pan/zoom function.
- **Current tilt/pan/zoom speed:** Use the drop down box to select the current speed for tilt/pan/zoom function.

12..50 Module Temperature Protection

Product group

LED

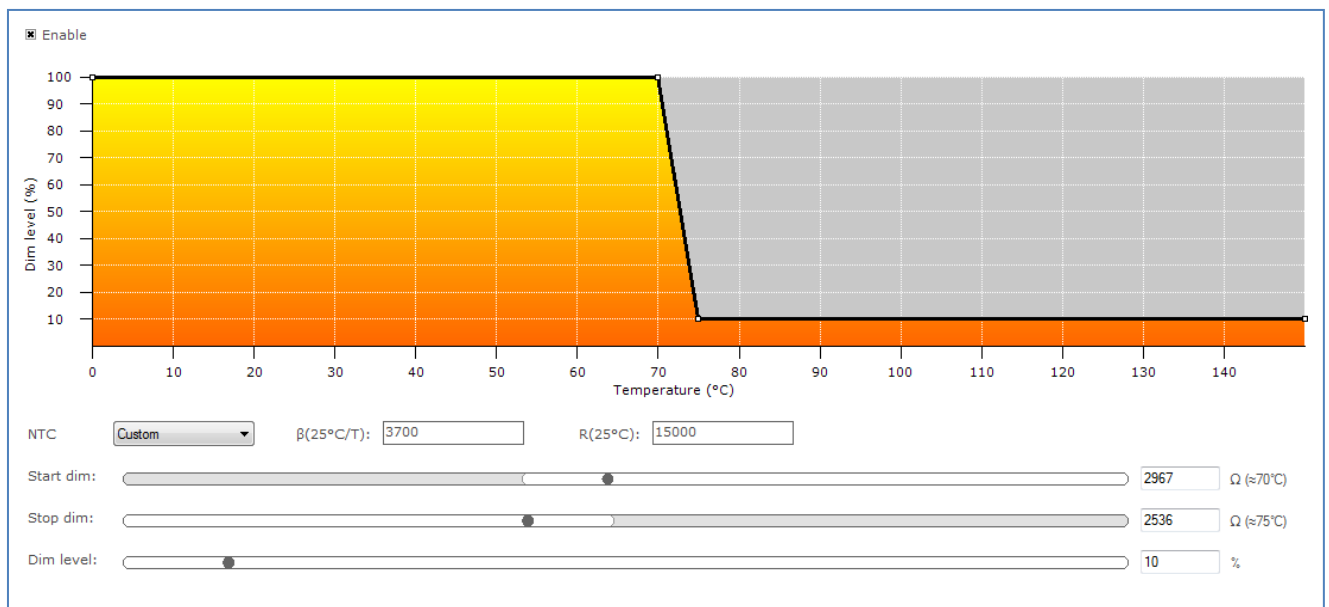

Description

Use this feature to regulate lamp power when the LED module gets too hot. At a certain temperature the lamp starts to dim in order to control temperature. At a critical temperature level the lamp will switch off completely.

Usage

Select the **Enable** check box to use this feature. Drag the points or the lines in the resulting graph to adjust the configuration. Alternatively, use the sliders to change values directly. Based on the device model, the feature is shown in either temperature (degrees Celsius) or resistance values (in Ohm).

Note! For a detailed technical description of the characteristics of the device model, like constraints and limitations, please refer to [Device-specific technical description](#).

12.51 NTC on LEDset

Product group

LED

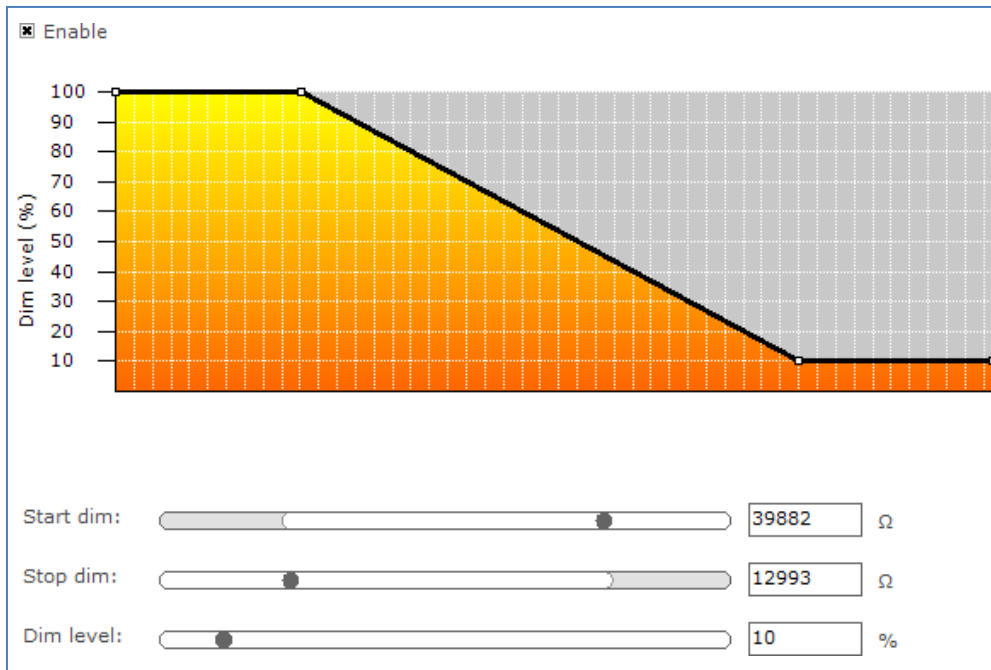

Description

Use this feature to regulate lamp power when the LED module gets too hot. At a certain temperature the lamp starts to dim in order to control temperature. Configure the resistance values to determine the dimming behavior.

Usage

Select the **Enable** check box to use this feature. Drag the points or the lines in the resulting graph to adjust the configuration. Alternatively, use the sliders to change values directly.

Note! For a detailed technical description of the characteristics of the device model, like constraints and limitations, please refer to [Device-specific technical description](#).

12.52 Occupancy Sensing / Daylight Harvesting

Product group

CONTROL

Hold time:	<input type="range"/>	<input type="text" value="15"/>	min
Prolong time:	<input type="range"/>	<input type="text" value="0"/>	min <input type="checkbox"/> Infinite
Background light level:	<input type="range"/>	<input type="text" value="20"/>	%
Grace fading:	<input type="range"/>	<input type="text" value="0"/>	s
<input checked="" type="checkbox"/> Occupancy			
<input checked="" type="checkbox"/> Daylight based control			
<input checked="" type="checkbox"/> LED indicator			
Occupancy mode:	<input type="text" value="auto on/off"/>		
Eco ON level:	<input type="range"/>	<input type="text" value="5"/>	%

Description

Use this feature in combination with the **EasySense** to setup an occupancy sensing and/or a daylight harvesting mode. The occupancy sensing mode configures how light is being controlled, based on occupancy information. The daylight harvesting mode configures how light is being controlled, based on the amount of light in an indoor space (contribution of natural light entering the indoor space).

Usage

The **Hold time** is the time whereby occupancy is no longer detected but the lights are still on and being regulated. The **Prolong time** is the time at which the background level is maintained at a fixed level. **Background light level** is the light level at which the lights will glow when no occupancy is detected and **Grace fading** is the time during which the lights are being dimmed down from the current light level to the background level.

The **Occupancy** check box enables/disables the occupancy sensing mode. The **Daylight based control** check box enables/disables the daylight harvesting mode. When the **LED indicator** is enabled, the 2 LED indicators on the sensor will become active. The yellow LED indicates whether the sensor is functional. The red LED indicates whether occupancy is detected when the hold time is not expired yet.

The **Occupancy mode** defines how the lights of the system will behave.

The **Eco ON level** is used relative to the **Field task tuning level**. Only difference is that the Eco ON level can be overruled with a switch. This can result in additional energy savings.

12.53 Occupancy sharing / Group light behavior

Product group

CONTROL

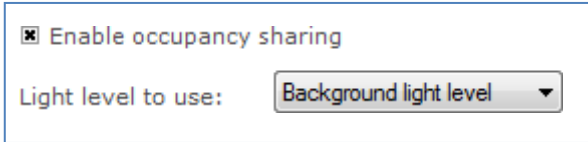

Enable occupancy sharing

Light level to use: Background light level ▼

Description

Use the OS/GLB feature to configure advanced grouping settings for the device.

Usage

This feature has the following parameters:

- **Enable occupancy sharing:** When the **Enable occupancy sharing** check box is selected, the group occupancy sharing is enabled.
- **Light level to use:** Select the **Background light level** or **Task light level** to indicate the desired light behavior when group is occupied and group occupancy sharing is enabled.

12.54 OEM Write Protection

Product group

LED

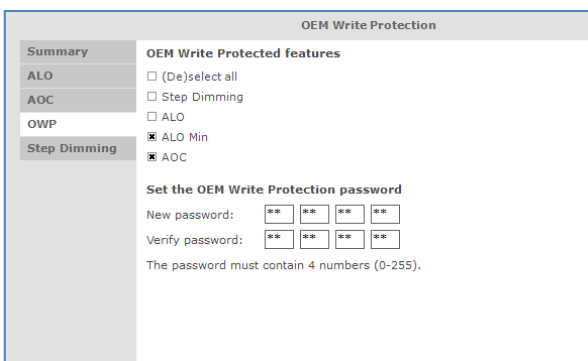

OEM Write Protection

Summary	OEM Write Protected features
ALO	<input type="checkbox"/> (De)select all
AOC	<input type="checkbox"/> Step Dimming
OWP	<input type="checkbox"/> ALO
Step Dimming	<input checked="" type="checkbox"/> ALO Min
	<input checked="" type="checkbox"/> AOC

Set the OEM Write Protection password

New password:

Verify password:

The password must contain 4 numbers (0-255).

Description

OEM Write Protection (OWP) defines a password that will be set in the driver so the data of OEM Write-protected features can only be written to the driver by providing the configured password.

Usage

When one or more of the **OEM Write Protected features** check boxes are selected, a password needs to be entered. This password must contain 4 numbers between 0 and 255. Passwords containing 0-0-0-0 and 255-255-255-255 are not allowed. The password needs to be verified before it can be stored in the driver. Once a password

is configured into the device, it is necessary to provide the current password when writing other features that are OEM Write-protected. These features are indicated by a padlock icon  in the **Write** screen.

When the OWP feature is read, only the values of the feature check boxes are shown on-screen, so it is not possible to retrieve the currently configured password.

12..55 Push Button Unit LCU2070

Product group

CONTROL/ActiLume DALI

Red:	<input type="text" value="All groups"/>
Purple:	<input type="text" value="Group 1"/>
Green:	<input type="text" value="Group 3"/>
Yellow:	<input type="text" value="Group 5"/>

Description

The push button unit can be used to trigger one or all groups when a button is pressed. In total there are four different buttons that can be configured.

Usage

Use the drop down boxes to select the group(s) that should be triggered when the corresponding button is pressed.

12..56 Push Button Unit LCU2071

Product group

CONTROL/ActiLume DALI

Red:	<input type="text" value="Scene 1"/>
Purple:	<input type="text" value="Scene 6"/>
Green:	<input type="text" value="Scene 11"/>
Yellow:	<input type="text" value="Scene 16"/>

Description

The push button unit can be used to trigger a scene when a button is pressed. In total there are four different buttons that can be configured.

Usage

Use the drop down boxes to select the scene that should be triggered when the corresponding button is pressed.

12..57 Quick Lamp Start

Product group

FLUO

<input checked="" type="checkbox"/> Enable
--

Description

When the **Enable** check box is selected, the lamp can be switched on immediately without the necessity for preheating the lamp. The preheat sequence (typically between 0.6 seconds and 1.0 seconds) will thus be skipped. This is possible because heating of the electrodes is not turned off.

Usage

Select the **Enable** check box to use this feature.

12..58 Relay Switched Output

Product group

CONTROL

Internal relay behavior

Always stays closed

Switches with SR input commands

Description

Use this feature to enable or disable the relay of the SR Bridge. This relay allows SR Bridge to switch off the connected DALI drivers either via the relay (disconnect input mains) or by giving a DALI OFF command.

Usage

Select one of the options to set the desired internal relay behavior.

12..59 Self Contained Emergency

Product group

LED

Output power: 100 %

Region selection:

Duration test acceptance time: 180 Minutes

SelfTest mode:

Function test interval: Days

Duration test interval: Weeks

Battery type:

Battery capacity: Enable manual selection

Description

Use the Self Contained Emergency (SCEM) feature to adjust the battery of rechargeable cells to create light in case of mains power outage.

Usage

- **Output power:** use the slider or the text field to select a value. The value represents the percentage of output power. The default is 100%.
- **Region selection:** use the drop down box to select the region specific mode. The default is Europe.
- **Duration test acceptance time:** use the slider or the text field to select a value. The value represents the emergency time. If the region selection is set to Australia mode, the emergency duration is fixed at 90 minutes.
- **SelfTest mode:** use the drop down box to select the standard mode (DALI or Fixed). The default is fixed.
- **Function test interval:** use the textbox to set the value. The value represents the number of days. If the selftest mode is set to fixed, the function test interval is set to 28.
- **Duration test interval:** use the textbox to set the value. The value represents the number of weeks. If the selftest mode is set to fixed, the duration test interval is set to 24.
- **Battery type:** use the drop down box to select the battery type value.
- **Battery capacity:** use the drop down box to select the battery capacity size. The value represents the capacity of battery cell count. This value only can be changed once the Enable manual selection is checked.

12..60 SR Power Supply

Product group

LED

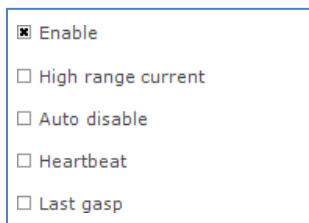

Enable
 High range current
 Auto disable
 Heartbeat
 Last gasp

Description

Use the SR Power Supply (SR PSU) feature to enable the device so it will deliver the power supply for DALI communication by itself.

Usage

Select the **Enable** check box to use this feature.

Select the **High range current** check box to enable the high range current functionality.

Select the **Auto disable** check box to enable the auto disable functionality.

Select the **Heartbeat** check box to enable the heartbeat functionality.

Select the **Last gasp** check box to enable the last gasp functionality.

12..61 Step Dimming

Product group

LED

Enable
 Mode: Bi-level Tri-level
 Bi active dim level: %

Enable
 Mode: Bi-level Tri-level
 Tri line 1 dim level: %
 Tri line 2 dim level: %

Description

Step dimming is the basic dimming requirement for energy efficiency.

Usage

Select the **Enable** check box to use this feature.

Select Bi-level radio button to edit Bi active dim level.

Select Tri-level radio button to edit Tri line dim levels.

12..62 Touch and Dim

Product group

FLUO, LED

Use last known level
 Power on level: (≈ 1 %)
 Ignore toggle limits

Description

This feature defines the startup behavior of a touch and dim controlled device after a power failure during dimming.

Usage

When the **Use last known level** check box is selected, the device will start up at the last known dim level that was used during dimming.

If this is not checked the power on level can be configured between 0 and 100% of the light.

When the **Ignore toggle limits** check box is selected, the normal toggle limits are ignored and dimming starts directly.

If this is not checked the normal toggle limits are used.

12..63 Tx Power

Product group

CONTROL

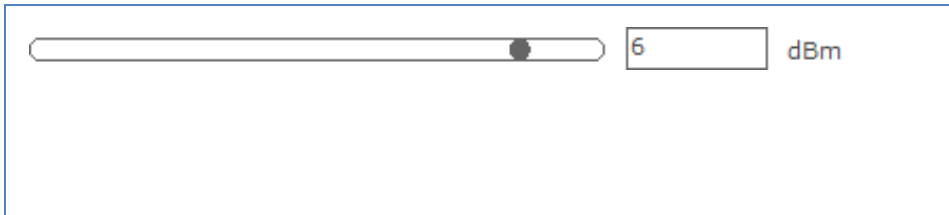

Description

Use this feature to modify the Tx power output level in order to tune/optimize the wireless performance of the luminaire.

Usage

Use the slider or the text field to select a value.

12.4 Using the features summary

For most devices an additional tab is shown on the **Device features** tab, called **Summary**. The **Summary** tab gives a compact overview of the settings that have been entered for all the features of this device. As the features are different per product group, the summary is also different. The features cannot be changed on the **Summary** tab.

Lamp selection		
Selected: HID CDO 250W		
Dynadimmer		AmpDim
Enabled:	Yes	Enabled: No
TimeBased:	No	
Mid point shift:	0 min	
Time	Level	Fade
00:00	1	180
06:00	100	180
Low percentage	60	
Low voltage	195	
High percentage	100	
High voltage	230	
ALO	CLO	LineSwitch
Enabled: No	Enabled: No	Enabled: No
Output: 100 %		High voltage level: 100 %
		Low voltage level: 50 %
Disabled features		
<ul style="list-style-type: none"> - CLO - LineSwitch - AmpDim - ALO 		

12.5 Saving and opening a feature configuration file

To save and open a feature configuration file, the **Device features** tab must be active.

Feature configurations can be saved to a file for later use. To do so, first select the **Device features** tab to make feature configurations for the selected device. Then, click the disk icon on the toolbar or select **File** → **Save as**.



A dialog window pops up that lists the features of the device:

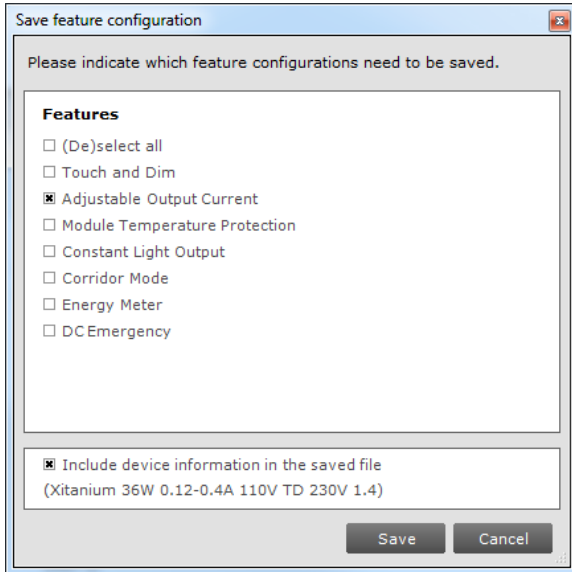

Select any number of features and click **Save**. The save file dialog window appears. Choose a location and a file name and click **Save**. The selected features will now be written to the file.

It is also possible to save the device information alongside the features. This data can later be used in MultiOne Workflow to ensure the configuration can only be configured in the saved device model.

As mentioned before, some features can be OEM Write-protected. These features will be marked with a padlock icon in the dialog.

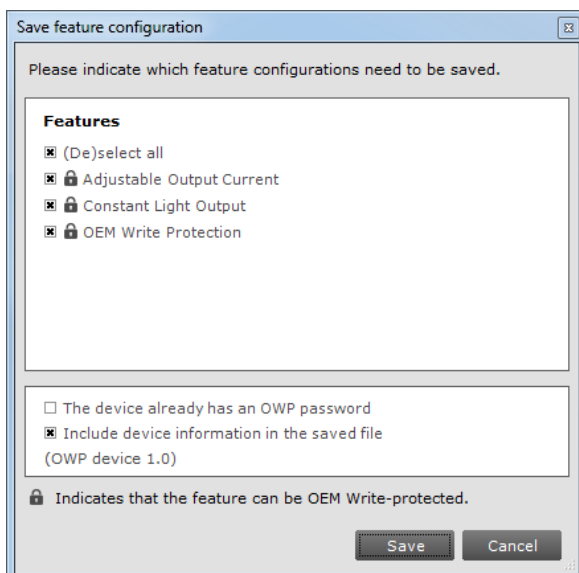

In this case it is possible to save the current password alongside the features, so MultiOne Workflow can use this password to be able to write the data of the features that are OEM Write-protected to the driver.

When using SimpleSet, MultiOne compares the provided password with the password in the device before writing the new data. When there is a mismatch, an error message will be shown.

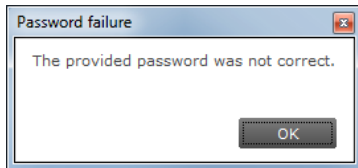

When using DALI, it is also possible to save DALI settings along with the feature configuration. This can be done by checking the **Include DALI settings in a separate file**.

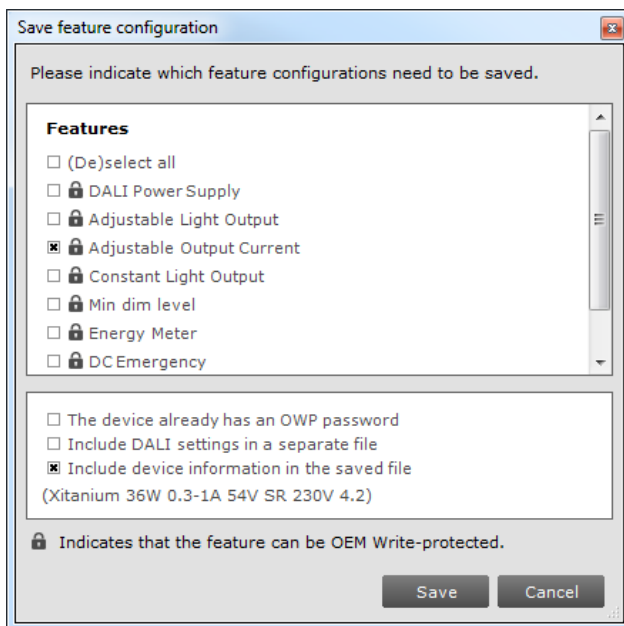

Note that this feature can be enabled or disabled from [Preferences](#).

To open a feature configuration file, click the folder icon on the toolbar or select **File** → **Open**. The open file dialog window appears. Select a file and click **Open**.

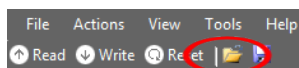

The contents of the **Device features** tab are updated to show the information that was read from the file.

Only feature configurations are stored in the file. This means that a file made for a certain device can be read into the **Device features** tab for a different device. MultiOne attempts to read as many feature configurations as possible.

Example: a feature configuration file exists that was made for device D1, which has features AOC, CLO and MTP. A different device, D2, has features AOC and Touch and Dim. When opening the feature configuration file for device D1 while device D2 is selected, only the configuration for feature AOC will be read, since features CLO and MTP are not supported by device D2.

Feature configuration files can be distributed to other users of MultiOne. This user then opens the file and configures the connected device.

12.6 Configuring a single device

There are situations in which only one device will be configured at the time. In this case it is not necessary to have the full functionality of the **Network**, including **Scan** and **Commission** buttons. To optimize the workflow for single device configuration, select **Single device programming** in the **Application Mode Selector**.

When **Single device programming** has been selected, MultiOne will automatically scan the DALI network and select the connected device for communication. In this mode, the **Network** panel is collapsed by default. If multiple devices have been found, MultiOne will show a message and switch to regular configuring mode.

12.7 Configuring multiple DALI devices (simultaneously)

There are situations in which multiple devices need to be configured at the same time. The procedure to simultaneously configure multiple devices of the SAME TYPE AND VERSION is as follows:

1. Connect maximum 64 devices of the SAME TYPE AND VERSION, in parallel to the DALI connectors of the USB2DALI interface
2. Connect the USB2DALI interface to the USB port (both black and red USB plugs (USB-A)).
3. Connect the devices to the mains.
4. Start MultiOne
5. Choose **Tools** → **Preferences**
6. Clear the **Write & verify** check box and click **OK**
7. Click the **Commission** button on the **Network** panel to start commissioning.
8. Choose **Actions** → **Add virtual device**.
9. Select the device of the same type and version as the ones connected on the **Network** panel.
10. Select the **Device features** tab
11. Change any of the features.
12. Click **Write** on the toolbar.

Note! There will not be an individual confirmation for every device. So if any of them failed to be configured, it is not known which one.

Note! Remember that applications can be affected by the availability of the short address.

12.8 Configuring multiple DALI devices (consecutively)

There are situations in which multiple devices need to be configured one after another. The procedure to consecutively configure multiple devices of the SAME TYPE AND VERSION should follow the next steps.

12.8.1 MultiOne

1. Connect one device
2. Connect the USB2DALI interface to the USB port (both black and red USB plugs (USB-A))
3. Connect the device to the mains
4. Start MultiOne
5. If needed, select **All** in the **Application mode selector**
6. Click **Scan network** in the **Network** panel to start scanning
7. Select **File**→**Open** to open the required feature configuration file
8. Right click the device in the **Network** panel and select **Reset short address**
9. Select the **Device features** tab
10. Click **Write** on the toolbar
11. Replace device
12. Click **Write** on the toolbar
13. Replace device
14. Etc.

Note! Remember that applications can be affected by the removal of the short address.

12.9 Configuring multiple ZigBee devices

There are situations in which multiple devices need to be configured one after another. The procedure to configure multiple devices of the SAME TYPE AND VERSION is described below.

1. Join multiple devices in a ZigBee network
2. Connect the USB2ZigBee interface to the USB port
3. Start MultiOne
4. If needed, select **All** in the **Application mode selector**

5. Click **Connect to network** in the **Network** panel to start scanning
6. Right click in the **Network** panel and select **Add virtual device...**
7. Select the device you want to configure and click **OK**
8. Configure the virtual device as desired
9. Select the virtual device in the **Network** panel and click **Write to current network...** in the **Actions** menu
10. (De)select the features you want to write in the pop-up that appears and click **Write**

Note! When devices of different types and/or versions are joined in the same network, only the features that correspond to the features of the virtual device will be configured. All other features will be ignored.

12.10 Offline feature configuration preparation

When a device or network is not present, it is still possible to prepare a feature configuration. This might be useful when you would like to prepare a feature configuration file that can be read at a later time, and written to the device when it is connected. To make a configuration you need to add one or more virtual devices.

To add a virtual device, right-click **All devices** in the **Network** and choose **Add virtual device**.

Alternatively choose **Actions** → **Add virtual device**.

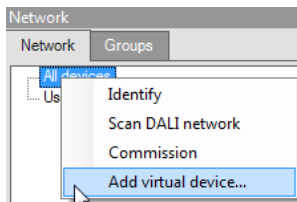

A dialog window pops up that lists all devices supported by MultiOne.

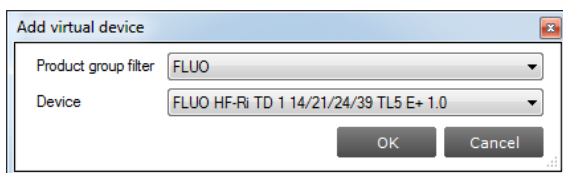

Make a selection and click **OK**. An item called **Virtual devices** appears in the **Network**. Expand it by clicking the **+** sign to see the list of virtual devices. Note that virtual devices do not have a short address and MultiOne will show **Broadcast** on the location of the short address. Virtual devices can only be addressed using broadcast commands.

Select a virtual device and select the **Device features** tab. The device features are shown as if the device was physically connected. Configure the features as desired, and then save the feature configuration to a file. You have now made a feature configuration file without being connected a device.

12.11 Sending DALI commands

To manually send DALI commands select the **Commands** tab.

The **Commands** tab contains the following tabs:

- 102 tab
- 202 tab

The **102** tab has the following specific pane:

- Light control

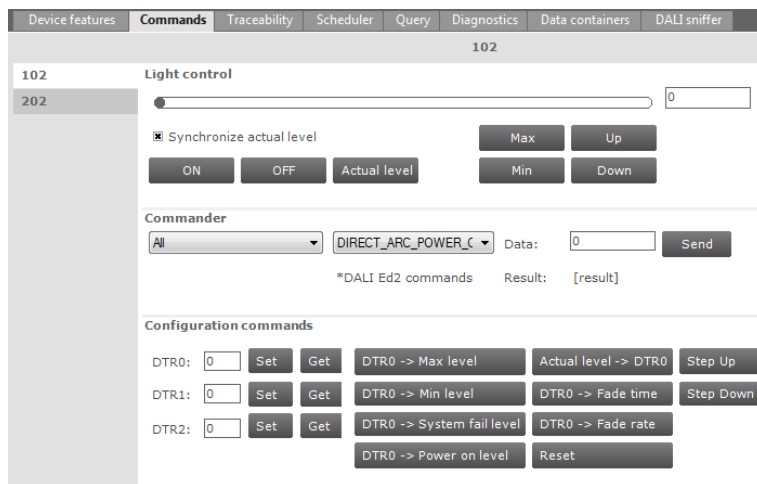

Light control

This pane offers a number of buttons to immediately influence the behavior of the device. These controls are useful when quick feedback in terms of light is desired. Selecting the **Synchronize actual level** check box will reflect the actual light level in the slider after each command.

The **202** tab has the following specific pane:

- Control Device

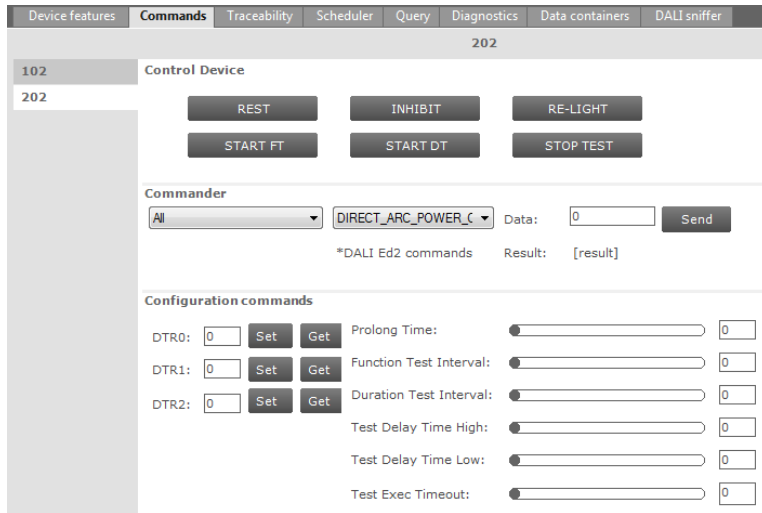

Control Device

This pane gives direct access to emergency controls that immediately influence the behavior of the emergency device. These controls allow users to get quick feedback in terms of the behavior of an emergency device in different situations.

Both tabs contain the following panes:

- Commander
- Configuration commands

Commander

To send a DALI command as a broadcast command, first select **All devices** in the **Network**, then select the DALI command in the **Commander** pane and finally click the **Send** button. To send a DALI command to a specific address or group, select the corresponding device or group in the **Network**.

Note! DALI Ed2 commands are marked by an asterisk (*).

Configuration commands

Both tabs contain this pane. However, the content of this pane is different for each tab. To manually set or get the so-called DTR (Data Transfer Register) values of the device, use the buttons in the left part of this pane.

To use the actual DTR value of the device with a number of DALI commands, go to 102 tab to use the buttons in the right part of this pane. Besides a number of DALI commands using the DTR value, other DALI102 commands such as **Reset**, **Step Up** and **Step Down** are directly available.

To configure values like **Prolong Time**, **Function Test Interval**, **Duration Test Interval**, **Test Delay Time High**, **Test Delay Time Low** and **Test Execution Timeout**

that are needed while using emergency commands, go to 202 tab to use the sliders or text fields in the right part of this pane to modify their values. The allowed range for those values is between 0 and 255.

12.12 Traceability

The Traceability tab summarizes how many times the configuration of the device was changed, when the last configuration change happened using unknown software and a pane showing details of the first, second and last configuration change (if present).

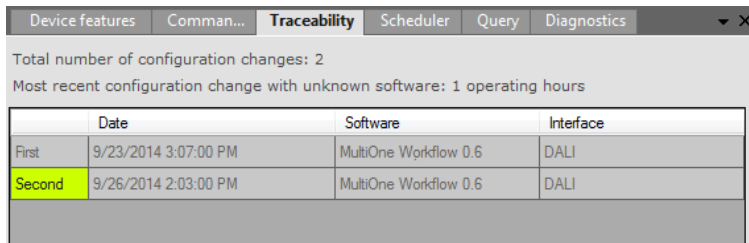

	Date	Software	Interface
First	9/23/2014 3:07:00 PM	MultiOne Workflow 0.6	DALI
Second	9/26/2014 2:03:00 PM	MultiOne Workflow 0.6	DALI

Every entry in the list shows the date of the configuration change, which software version was used and which type of interface was used at the time of the configuration change.

12.13 Working with DALI command scripts

To run a series of DALI commands, a script can be created in the **Scheduler** tab. This script can be executed any number of times. Furthermore it is possible to save the script to a file for easy reuse.

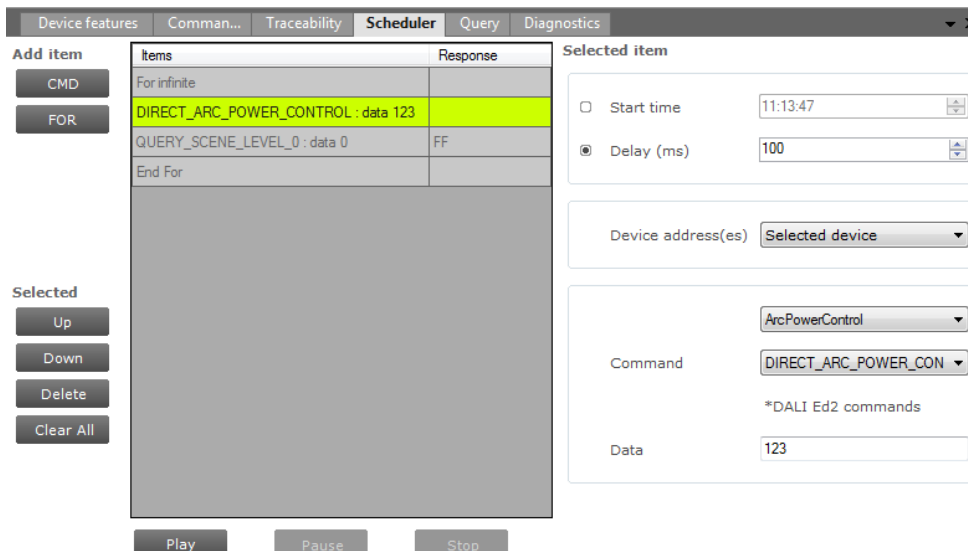

Add item	Items	Response
CMD	For infinite	
FOR	DIRECT_ARC_POWER_CONTROL : data 123	
	QUERY_SCENE_LEVEL_0 : data 0	FF
	End For	

Selected item

Start time: 11:13:47
 Delay (ms): 100

Device address(es): Selected device

Command: ArcPowerControl
DIRECT_ARC_POWER_CON

Data: 123

The **Scheduler** tab has the following panes:

- Add item

- A **CMD** button to insert DALI commands
- A **FOR** button to insert a loop, consisting of a FOR and an END FOR
- Selected, containing buttons to work with (**Up**, **Down**, **Delete**, **Clear All**) the currently selected item in the schedule
- Items, representing the schedule
- Selected item, the settings of the currently selected item
- Schedule playback buttons (**Play**, **Pause**, **Stop**)

To add a command to the schedule, click the **CMD** button. The command is added to the schedule and it is automatically highlighted. On the **Selected item** pane, choose the desired DALI command and settings. By selecting the **Start time** check box and providing a time, this command will be sent at an exact moment in time.

Alternatively, commands can be sent relative to each other. Select the **Delay** check box and provide a value in milliseconds to do so. At **Device address** you can select to which device to send this command. You can choose between the currently selected device, a broadcast or one of the 64 available short addresses (0-63). Then, select which DALI command will be sent by using the two drop down boxes; the first selects the command group and the second selects the actual command. If a command parameter is required, enter it into the **Data** field.

Note! DALI Ed2 commands are marked by an asterix(*).

By repeatedly clicking the **CMD** button, a series of DALI commands can be created. Each command has its own settings.

A schedule can also contain loops. A loop has a FOR-item, one or more commands, and finally an END FOR-item to mark the end of the loop. Click the **FOR** button to create a loop. By default, the loop will run infinitely (that is, until schedule playback is manually stopped or paused by clicking **Stop** or **Pause**). To change the number of times the loop will be executed, select the FOR-item and enter a value for **Maximum count** on the **Selected item** pane.

To rearrange the schedule, select a command and use the **Up** and **Down** buttons to move this up or down respectively. Delete a command by clicking the **Delete** button. To clear all the commands use **Clear All** button.

To start, pause, or stop a schedule playback, use the **Play**, **Pause** and **Stop** buttons. If the command is a query, the return data of the executed command will be displayed.

To save a schedule to file for later use, click the disk icon on the toolbar. Alternatively, select **File** → **Save** or **File** → **Save As**. Choose a location, a filename and click **Save**. The schedule has now been saved.

To open a previously stored schedule, click the folder icon on the toolbar.

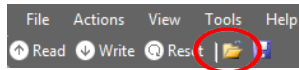

Alternatively, select **File** → **Open**. Choose a schedule file and click **Open**. The **Scheduler** tab now shows the schedule from the file.

12.14 Querying devices

To automatically execute a number of standard DALI query commands select the **Query** tab.

Device features					
Comman...					
Traceability					
Scheduler					
Query					
Diagnostics					
<input type="checkbox"/> Enable DALI Ed 2					
DALI Ed 1					
Status	194	Max level	254	Scene level 0	255
Control gear present	255	Min level	126	Scene level 1	255
Lamp failure	255	Power on level	254	Scene level 2	255
Lamp power on	0	System failure	254	Scene level 3	255
Limit error	0	Fade time/rate	7	Scene level 4	255
Reset state	0	Groups 0 - 7	0	Scene level 5	255
Version number	1	Groups 8 - 15	0	Scene level 6	255
Extended version	0	Random address H	125	Scene level 7	255
Content DTR 0	3	Random address M	17	Scene level 8	255
Content DTR 1	100	Random address L	172	Scene level 9	255
Content DTR 2	2	Missing short address	255	Scene level 10	255
Device type	0	Power failure	255	Scene level 11	255
Physical min	126			Scene level 12	255
Actual level	255			Scene level 13	255
				Scene level 14	255
				Scene level 15	255
DALI Ed 2					
Operating mode	0	Next device type	0	Manufacturer mode	0
Light source type	0	Extended fade time	0	Control gear failure	0

To make sure that the information in the **Query** tab corresponds to the selected device, click **Read** on the toolbar.

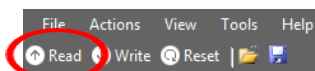

12.15 Accessing Diagnostics

You can configure all diagnostics features that are supported by a specific device. For a device selected in the **Network**, the **Diagnostics** tab displays the set of diagnostics features that corresponds to this device. Upon selecting another device, the **Diagnostics** tab will be updated as well. This mechanism ensures that only the features supported by the selected device can be configured.

The **Diagnostics** tab has a panel with a column of tabs on the left-hand side. Each feature has its own tab.

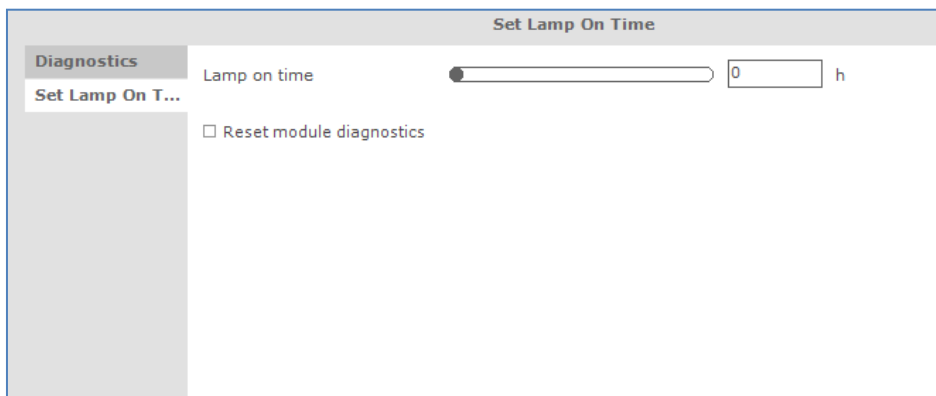

The **Read** and **Write** functionality for **Diagnostics** works the same way as what has been described in chapter 12.3 of this manual.

12.15.1 Diagnostics

Product group

HID, LED and CONTROL

Description

Use this feature to consult the diagnostics values.

Note that some diagnostics might be OEM Readout-protected and require a password before being read out.

12.15.1.1 Diagnostics for a HID

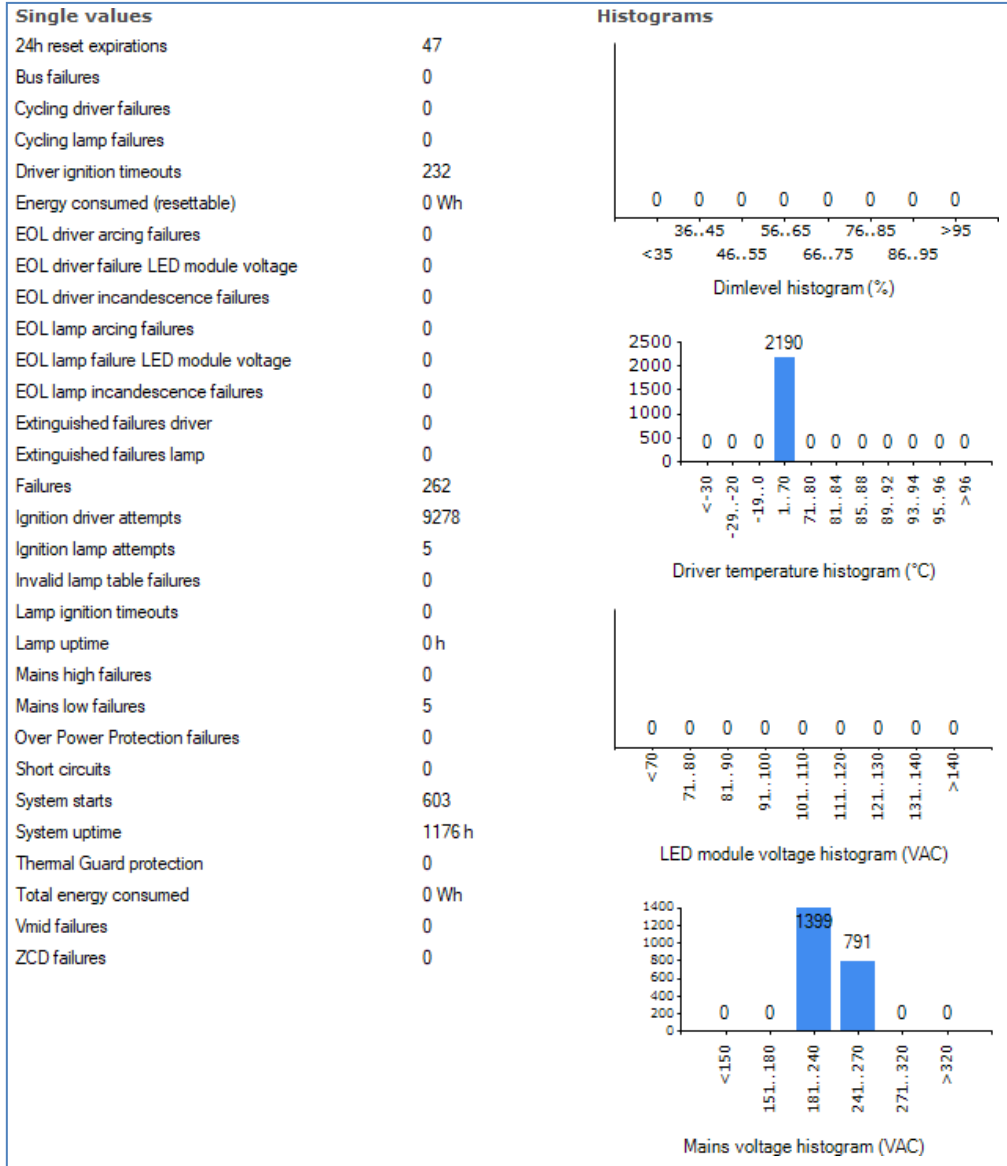

A brief explanation of all HID diagnostics is given below.

Table 1 HID diagnostics

Diagnostic	Description
System starts	Number of times the HID driver was switched on (via the mains).
System uptime (h)	Total time the HID driver was on.
Lamp uptime (h)	Total lamp burning time.
Ignition driver attempts	Number of times the HID driver attempted to ignite a lamp.
Ignition lamp attempts	Number of times the HID driver attempted to ignite the lamp, since last lamp replacement ^{a)} .
Failures	Total number of failures detected by the HID driver.

Total energy consumed (Wh)	Total energy consumed by the HID driver.
Energy consumed (resettable) (Wh)	Energy consumed since last user-reset.
24H reset expirations	HID driver was operating for more than 24 hours; any failures blocking driver to operate the lamp are cleared
Thermal Guard Protection	Thermal Guard activated as a consequence of high temperature level.
EOL driver incandescence failures	End-Of-Life situation showing incandescent mode of operation of the lamp.
EOL lamp incandescence failures	End-Of-Life situation showing incandescent mode of operation of the lamp, since last lamp replacement ^{a)} .
EOL driver arcing failures	End-Of-Life situation showing an arcing mode of operation of the lamp.
EOL lamp arcing failures	End-Of-Life situation showing an arcing mode of operation of the lamp, since last lamp replacement ^{a)} .
EOL driver failure lamp voltage	End-Of-Life situation showing a lamp voltage level that was out of operating range.
EOL lamp failure Lamp voltage	End-Of-Life situation showing a lamp voltage level that was out of operating range, since last lamp replacement ^{a)} .
Driver ignition timeouts	Failed to successfully ignite the lamp.
Lamp ignition timeouts	Failed to successfully ignite the lamp, since last lamp replacement ^{a)} .
Cycling driver failures	Cycling of the lamp (extinguished for more than N times subsequently) [where N depends on lamp type].
Cycling lamp failures	Cycling of the lamp (extinguished for more than N times subsequently), since last lamp replacement [where N depends on lamp type] ^{a)} .
Extinguished failures driver	Detection of an extinguished lamp.
Extinguished failures lamp	Detection of an extinguished lamp, since last lamp replacement ^{a)} .
Mains high failures	Mains voltage level detected that was too high to continue operation.
Mains low failures	Mains voltage level detected that was too low to continue operation.
Bus failures	Bus voltage level detected that was out of operating range.

Vmid failures	Midpoint voltage level detected that was out of operating range.
Short circuits	Short circuit detected in the lamp connection.
ZCD failures	Critical failure detected in lamp or driver.
Over Power Protection failures	Over power detected.
Invalid lamp table failures	HID driver switched-on with a non-supported or corrupt lamp table selected.

a) lamp replacement triggers an erase of predefined lamp-specific items such as ignition attempts, lamp errors.

12.15.1.2 Diagnostics for a LED

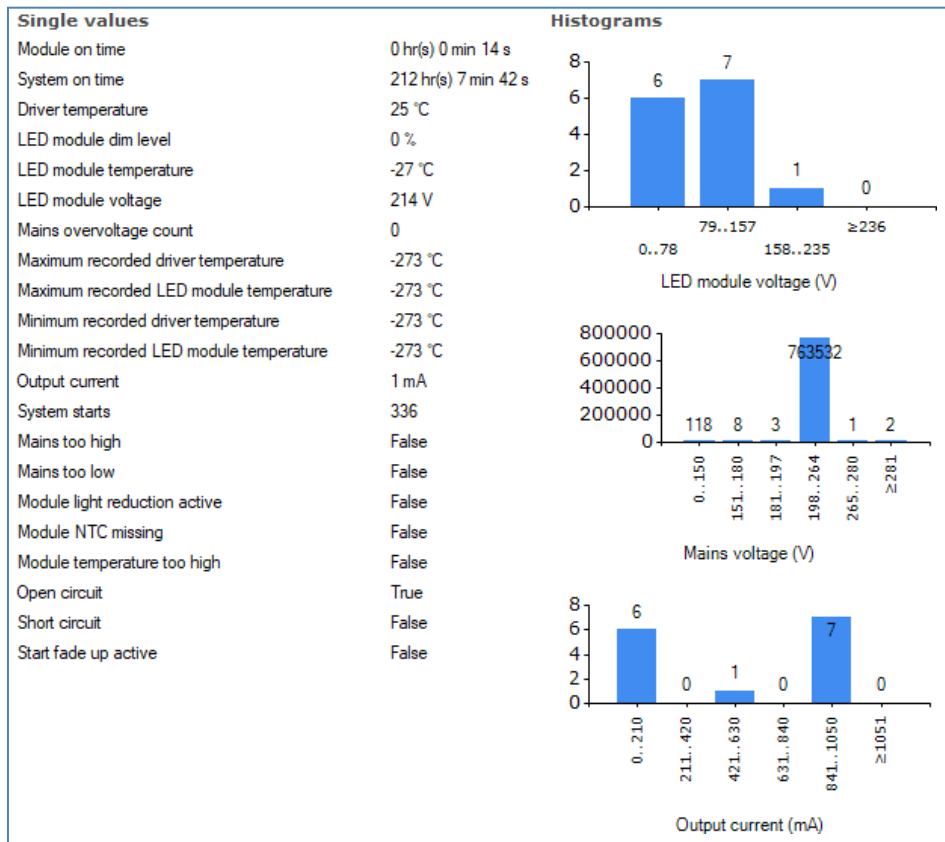

A brief explanation of all LED diagnostics is given below.

Table 2 LED diagnostics

Diagnostic	Description
LED module voltage (V)	Represents the output LED module voltage.
LED module current (mA)	Represents the output LED module current
LED module dim level (%)	Represents the current dim level set by the LED driver. Takes into account all factors that can influence dimming like Constant Light Output,

	Module Temperature Protection, all dimming interfaces etc.
LED module temperature (°C)	Represents the LED module temperature. Available only when Module Temperature Protection is selected and an NTC value is selected.
Driver temperature (°C)	Represents the internal driver temperature. It does not represent T_{case} of the driver. Though there is a correlation between T_{case} and internal driver temperature, the difference can vary depending on current setting of driver.
System starts	Represents the number of times the LED driver is powered ON.
System on time (h)	Represents the hours the LED driver is ON. (LED module is OFF)
Module on time (h)	Represents the number of hours the LED module is powered ON.
Module energy consumed	Represents the energy consumed by LED module alone. Only output parameters (LED module voltage and current) are used to calculate energy. The LED driver energy consumption is not accounted. Hence it does not represent true input energy consumption of the LED system.
Short circuit	This indicates if output LED module is shorted.
Open circuit	This indicates if output LED module is open or not connected to LED driver
Module NTC missing	This indicates missing NTC on the LED module. Available only when Module Temperature Protection is selected and 10k NTC is selected. Missing NTC flag will not be activated if 15k+390 Ω NTC is selected.
Module temperature reduction active	This indicates light level reduction due to module temperature being active.
Module temperature too high	This indicates whether the LED module temperature exceeds 90 °C causing module to turn OFF.

Mains too low	This indicates that the LED driver is not operating since input voltage at power ON is too low.
Adjustable Startup Time active	This indicates that the LED driver is in the startup phase as defined by the Adjustable Startup Time. For example if the Adjustable Startup Time is set to 20000 ms, and the diagnostic information is read at startup within 20 s, this check box will be selected indicating startup condition.

12.15.1.3 Subset of LED diagnostics

Single values	
Module on time	0 hr(s) 0 min 0 s
System on time	32 hr(s) 15 min 16 s
Driver temperature	21 °C
Fault code 01	0
Fault code 02	0
Fault code 03	0
Fault code 04	0
Fault code 05	0
Fault code 06	0
Fault code 07	0
Fault code 08	0
Fault code 09	0
Fault code 10	0
Lamp on cycles count	0
LED module dim level	0 %
LED module temperature	-273 °C
LED module voltage	0 V
Mains overvoltage count	0
Maximum recorded driver temperature	44 °C
Maximum recorded LED module temperature	-273 °C
Minimum recorded driver temperature	23 °C
Minimum recorded LED module temperature	-2147483648 °C
Output current	0 mA
System starts	8

Table 3 Subset of LED diagnostics

Diagnostic	Description
System on time (h:m:s)	Represents the hours, minutes and seconds the LED driver is ON. (LED module is OFF).
Module on time (h:m:s)	Represents the number of hours, minutes and seconds the LED module is powered ON.
System starts	Represents the number of times the LED driver is powered ON.
Maximum recorded driver temperature (°C)	Maximum driver temperature ever reached during the lifetime of the driver.

Minimum recorded driver temperature (°C)	Minimum driver temperature ever reached during the lifetime of the driver.
Maximum recorded LED module temperature (°C)	Maximum module temperature ever reached during the lifetime of the driver.
Minimum recorded LED module temperature (°C)	Minimum module temperature ever reached during the lifetime of the driver.
Mains overvoltage count	Number of times the mains exceeded the maximum allowed mains voltage level.

The table above describes some of the available diagnostic features. Depending on the availability of the different LED subset diagnostic features in a device, more or less diagnostic values will be shown.

12.15.1.4 Motor control diagnostics

Single values	
Lamp on time	51 hr(s) 8 min 30 s
Pan motor on time	0 hr(s) 0 min 0 s
Tilt motor on time	0 hr(s) 0 min 0 s
Zoom motor on time	0 hr(s) 0 min 0 s
Pan motor move count	0
Tilt motor move count	0
Zoom motor move count	0

Table 4 Motor control diagnostics

Diagnostic	Description
Lamp on time (h:m:s)	Represents the number of hours, minutes and seconds the lamp is on.
Pan motor on time (h:m:s)	Represents the number of hours, minutes and seconds the pan motor is on.
Tilt motor on time (h:m:s)	Represents the number of hours, minutes and seconds the tilt motor is on.
Zoom motor on time (h:m:s)	Represents the number of hours, minutes and seconds the zoom motor is on.
Pan motor move count	Represents the number of times of the pan motor received a movement command.
Tilt motor move count	Represents the number of times of the tilt motor received a movement command.
Zoom motor move count	Represents the number of times of the zoom motor received a movement command.

12.15.1.5 *Emergency Diagnostics*

Single values	
Lamp emergency time	0 h
Lamp total operation time	0 h
Last duration test time	0 m
Time since last duration test	7 h
Total number of discharge cycles	0

Table 5 Emergency diagnostics

Diagnostic	Description
Lamp emergency time (h)	Represents the number of hours the lamp was in emergency mode.
Lamp total operation time (h)	Represents the number of hours the lamp is on.
Last duration test time (m)	Represents the number of minutes the last duration test took to run.
Time since last duration test (d:h:m)	Represents the time passed since the last performed duration test, mentioned in days, hours or minutes.
Total number of discharge cycles	Represents the total number of battery discharge cycles.

12.15.1.6 *DiiA specification DALI Part 253 - Diagnostics*

Single values	
Control gear operating time	52 hr(s) 48 min 2 s
Control gear start counter	14
Control gear external supply voltage	230,0 Vrms
Control gear external supply voltage frequency	50 Hz
Control gear power factor	Not Available
Control gear overall failure condition	False
Control gear overall failure condition counter	0
Control gear external supply undervoltage	False
Control gear external supply undervoltage counter	0
Control gear external supply overvoltage	False
Control gear external supply overvoltage counter	0
Control gear output power limitation	Not Available
Control gear output power limitation counter	0
Control gear thermal derating	Not Available
Control gear thermal derating counter	0
Control gear thermal shutdown	Not Available
Control gear thermal shutdown counter	0
Control gear temperature	43 °C
Control gear output current percent	0 %
Light source start counter resettable	0
Light source start counter	0
Light source on time resettable	97486 hr(s) 0 min 0 s
Light source on time	0 hr(s) 0 min 0 s
Light source voltage	6553,5 V
Light source current	65,535 A
Light source overall failure condition	True
Light source overall failure condition counter	14
Light source short circuit	Not Available
Light source short circuit counter	0
Light source open circuit	True
Light source open circuit counter	14
Light source thermal derating	Not Available
Light source thermal derating counter	0
Light source thermal shutdown	Not Available
Light source thermal shutdown counter	0
Light source temperature	195 °C

Table 6 DiiA diagnostics

Diagnostic	Description
Control gear operating time (h:m:s)	Represents the operating time of the control gear in hours, minutes and seconds.
Control gear start counter	Represents the amount of times the control gear started.
Control gear external supply voltage (Vrms)	Represents the external supply voltage of the control gear in Vrms.
Control gear external supply voltage frequency (Hz)	Represents the external supply voltage frequency of the control gear in Hz.

Control gear power factor	Represents the power factor of the control gear.
Control gear overall failure condition	Represents the overall failure condition of the control gear.
Control gear overall failure condition counter	Represents the amount of times the control gear overall failure condition occurred.
Control gear external supply undervoltage	Represents the external supply under voltage of the control gear.
Control gear external supply undervoltage counter	Represents the amount of times the control gear external supply undervoltage occurred.
Control gear external supply overvoltage	Represents the external supply overvoltage of the control gear.
Control gear external supply overvoltage counter	Represents the amount of times the control gear external supply overvoltage occurred.
Control gear output power limitation	Represents the output power limitation of the control gear.
Control gear output power limitation counter	Represents the amount of times the control gear output power limitation occurred.
Control gear thermal derating	Represents the thermal rating of the control gear.
Control gear thermal derating counter	Represents the amount of times the control gear thermal derating occurred.
Control gear thermal shutdown	Represents the thermal shutdown of the control gear.
Control gear thermal shutdown counter	Represents the amount of times the control gear thermal shutdown occurred.
Control gear temperature (°C)	Represents the temperature of the control gear in °C.
Control gear output current percent (%)	Represents the output current percentage of the control gear in %.
Light source start counter resettable	Represents the resettable amount of starts of the light source.

Light source start counter	Represents the amount of starts of the light source.
Light source on time resettable (h:m:s)	Represents the resettable light source operating time in hours, minutes and seconds.

Light source on time (h:m:s)	Represents the light source operating time in hours, minutes and seconds.
Light source voltage (V)	Represents the light source voltage in V.
Light source current (A)	Represents the light source current in A.
Light source overall failure condition	Represents the overall failure condition of the light source.
Light source overall failure condition counter	Represents the amount of times the light source overall failure condition occurred.
Light source short circuit	Represents the short circuit status of the light source.
Light source short circuit counter	Represents the amount of times the light source short circuit occurred.
Light source open circuit	Represents the open circuit status of the light source.
Light source open circuit counter	Represents the amount of times the light source open circuit occurred.
Light source thermal derating	Represents the thermal rating of the light source.
Light source thermal derating counter	Represents the amount of times the light source thermal derating occurred.
Light source thermal shutdown	Represents the thermal shutdown of the light source.
Light source thermal shutdown counter	Represents the amount of times the light source thermal shutdown occurred.
Light source temperature (°C)	Represents the temperature of the light source in °C.

Depending on the availability of the different DiiA diagnostic features in a device, more or less diagnostic values will be shown.

12.15.2 Set Lamp On Time

Product group

LED

Description

Use this feature to set the lamp on time or reset the diagnostics values.

Usage

Use the slider or the text field to set the **Lamp on time** value.

Select the **Reset module diagnostics** check box to reset the following diagnostics:

- Lamp on time counter
- Maximum and minimum module temperature
- Module Steady state temperature histogram
- Lamp On Cycles

12.16 Accessing Energy Meter

To access energy meter, select a device in the **Network** and select the **Energy Meter** tab. This tab displays the set of energy meter features that correspond to this device to get an indication of the energy consumption of the device. Upon selecting another device, the **Energy Meter** tab will be updated as well. This mechanism ensures that only the features supported by the selected device can be configured.

The **Energy Meter** tab has a panel with a column of tabs on the left-hand side. Each feature has its own tab.

Energy Meter		
↑ DALI 252	Total active energy consumed	89 Wh
↑ Energy Meter	Active energy consumed	2177 mWh
	Active power	16 dW
	Total apparent energy consumed	152 Wh
	Apparent energy consumed	3586 mWh
	Apparent power	26 dW
	Total active energy consumed at load side	0 Wh
	Active energy consumed at load side	0 mWh
	Active power at load side	0 dW

The **Read** functionality for **Energy Meter** works the same way as what has been described in chapter 12.3 of this manual. **Write** functionality is not available for **Energy Meter**.

12.16.1 Energy Meter

Total active energy consumed	89	Wh
Active energy consumed	2177	mWh
Active power	16	dW
Total apparent energy consumed	152	Wh
Apparent energy consumed	3586	mWh
Apparent power	26	dW
Total active energy consumed at load side	0	Wh
Active energy consumed at load side	0	mWh
Active power at load side	0	dW

12.16.2 DiiA specification DALI Part 252 - Energy reporting

Active energy	89	E0 Wh
Active power	16	E-1 W
Apparent energy	152	E0 VAh
Apparent power	26	E-1 VA
Active energy loadside	281474976710655	E0 Wh
Active power loadside	4294967295	E-1 W

Depending on the availability of the different DiiA Energy Meter features in a device, more or less energy meter values will be shown.

12.17 Accessing Installer

You can configure all installer features that are supported by a specific device. For a device selected in the **Network**, the **Installer** tab displays the set of installer features that corresponds to this device. Upon selecting another device, the **Installer** tab will be updated as well. This mechanism ensures that only the features supported by the selected device can be configured.

The **Installer** tab has a panel with a column of tabs on the left-hand side. Each feature has its own tab.



12.17.1 Coded Light Randomize

Product group

LED

 Randomize

Description

Use this feature to create a random id for coded light data.

Usage

When the **Randomize** flag is enabled, the device will generate a new random id, write this id into coded light data and clear the flag.

12.18 Working with the DALI Sniffer

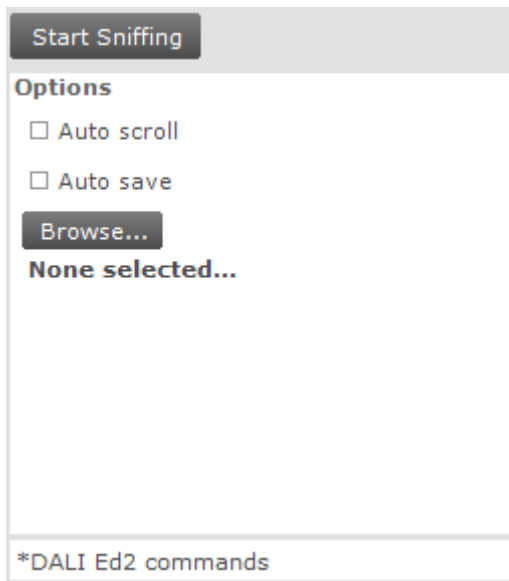

- **Start Sniffing/Stop Sniffing:** When clicked, starts/stops the actual sniffing
- **Auto scroll:** When checked the result window automatically scrolls to the latest entry.
- **Auto save:** Automatically save the sniffing results to the selected file
- **Browse...:** Select file to store sniffing results.

To save the result to a file that is not the auto save file, click on the save button in the menu bar.

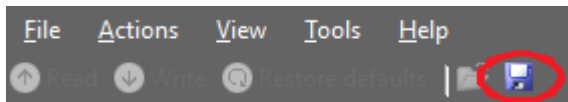

An example:

Timestamp	Time Delta Between Frames(us)	Answer	Data	Address	Command ID	Command	Error
6/12/2015 09:48:53.4	0	Write	0x0590	SHORT_2	Cmd_144	QUERY_STATUS	
6/12/2015 09:48:53.4	20820	Read	0x82	-	-	130	
6/12/2015 09:48:53.5	32550	Write	0x0591	SHORT_2	Cmd_145	QUERY_CONTROL_G...	
6/12/2015 09:48:53.5	20460	Read	0xFF	-	-	255	
6/12/2015 09:48:53.5	29140	Write	0x0592	SHORT_2	Cmd_146	QUERY_LAMP_FAILU...	
6/12/2015 09:48:53.5	20890	Read	0xFF	-	-	255	
6/12/2015 09:48:53.6	32090	Write	0x0593	SHORT_2	Cmd_147	QUERY_LAMP_POW...	
6/12/2015 09:48:53.6	34490	Write	0x0594	SHORT_2	Cmd_148	QUERY_LIMIT_ERROR	
6/12/2015 09:48:53.6	36490	Write	0x0595	SHORT_2	Cmd_149	QUERY_RESET_STA...	
6/12/2015 09:48:53.7	55260	Write	0x0597	SHORT_2	Cmd_151	QUERY_VERSION_N...	
6/12/2015 09:48:53.7	20480	Read	0x08	-	-	8	
6/12/2015 09:48:53.8	27870	Write	0x05FF	SHORT_2	Cmd_255	QUERY_EXTENDED_...	
6/12/2015 09:48:53.8	35940	Write	0x0598	SHORT_2	Cmd_152	QUERY_CONTENT_D...	
6/12/2015 09:48:53.8	20910	Read	0x12	-	-	18	
6/12/2015 09:48:53.8	34080	Write	0x059C	SHORT_2	Cmd_156	QUERY_CONTENT_D...	

Column 1 - Timestamp:	The time stamp of the message
Column 2 - Time delta between Frames (us)	The time difference in microseconds between two consecutive commands
Column 3 - Answer	The answer type, either an read or write message
Column 4 - Data	The data being send or received
Column 5 - Command ID	The ID of a command (only if a command is used)
Column 6 - Command	The known DALI command name, if no command then decimal value of the received Data
Column 7 - Error	The kind of error that might have occurred

The color of a line in the sniffer pane indicates the type of the DALI command.

12.18.1 Sniffing with multiple interfaces

It is possible to sniff multiple DALI networks on the same PC. To do this:

- Connect multiple USB2DALI devices to the PC.
- In MultiOne go to the Preferences window and select the **Show connection settings on startup** option.
- Start MultiOne multiple times and select different interfaces.
- Once all MultiOnes are started, start in each MultiOne the sniffer.

Note! When multiple MultiOnes connect to the same interface, the sniffing will not work anymore.

12.19 Art-Net export functionality

Art-Net has the possibility to export different features from multiple drivers to extensible markup language (.xml) type of file for easy usage later on. The export functionality is available under the **Actions** menu.

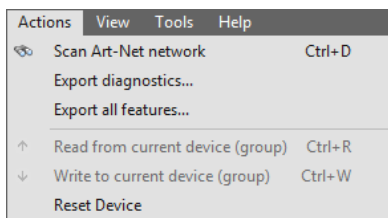

The following two options are available to the user:

- **Export diagnostics:** Retrieve the diagnostic values from the selected device(s)

- **Export all features:** Retrieve all features from the selected device(s)

If the user selects either one of the options he will then be able to select the drivers from which he would like to export the information from. The shown list contains all available devices from the network, even the ones that do not support this functionality, but the user will be unable to select the non-supported devices.

Selected devices

4 device(s) found

<input type="checkbox"/>	UID	Device name	Supported
<input type="checkbox"/>	50:68:41:54:B0:33	LED HP 350W 1.10 1.16	Yes
<input type="checkbox"/>	50:68:41:54:B0:34	LED HP 350W 1.10 1.16	Yes
<input checked="" type="checkbox"/>	50:68:41:54:B0:35	LED HP 350W 1.10 1.16	Yes
<input type="checkbox"/>	50:68:41:54:B0:36	LED HP 350W 1.10 1.16	Yes

Once all needed devices are selected the user could **start exporting** the data.

Please wait while exporting diagnostics...
 Processing Device: 50:68:41:54:B0:33: LED HP 350W 1.10 1.16
 Progress: 4 device(s) remaining

During the export the user will receive short updates on what device currently is being processed and how many devices are still remaining.

Summary

Time: 0 hours 0 min 6 sec 501 ms

Result: 4 device(s) exported successfully

<input type="checkbox"/>	Address	Device	Version	Result	Date	MultiOne version	Diagnostics version	LED modu volta
<input checked="" type="checkbox"/>	50:68:41:54:B0:33	LED HP 350W 1.10	1.16	OK	8/27/2015 12:07 PM	2.10.0.0	0	0
<input type="checkbox"/>	50:68:41:54:B0:34	LED HP 350W 1.10	1.16	OK	8/27/2015 12:07 PM	2.10.0.0	0	0
<input type="checkbox"/>	50:68:41:54:B0:35	LED HP 350W 1.10	1.16	OK	8/27/2015 12:07 PM	2.10.0.0	0	0
<input type="checkbox"/>	50:68:41:54:B0:36	LED HP 350W 1.10	1.16	OK	8/27/2015 12:07 PM	2.10.0.0	0	0

Once the export is finished the user is then presented with the final result in a simple overview. The user could make a selection of what devices it would like to save the data from and **save** this to a supported file type.

12.20 DALI Firmware update

MultiOne can be used to update the driver firmware of DALI devices. The remote firmware update functionality is available under the **Actions** menu when at least one device is discovered in the network.

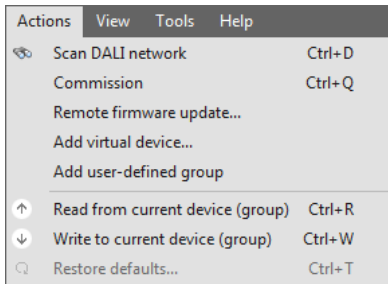

On selecting the Remote firmware update option the user is asked to select the update file. After selecting the file, the details of the file are displayed.

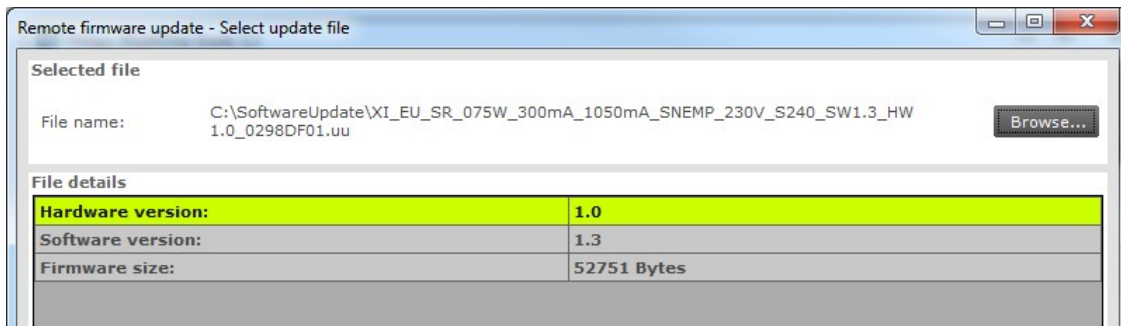

Click **Next** to continue the update procedure. On the following screen the user can configure the update settings used during the update procedure. If the connected device needs a password and access level before the remote firmware update can start, then the **Password** and **Access level** fields will be enabled so that the user can specify them.

The following update settings can be specified:

- **Password:** The password needed for unlocking the device before the remote software update can start.
- **Access level:** The access level needed for unlocking the device before the remote software update can start.
- **Number of attempts:** The number of automatic attempts done for every update step in case a failure occurs during the remote firmware update procedure.

Note! If a 4-byte password is desired, fill the first 3 text boxes with 0.

Click **Next** to continue the update procedure.

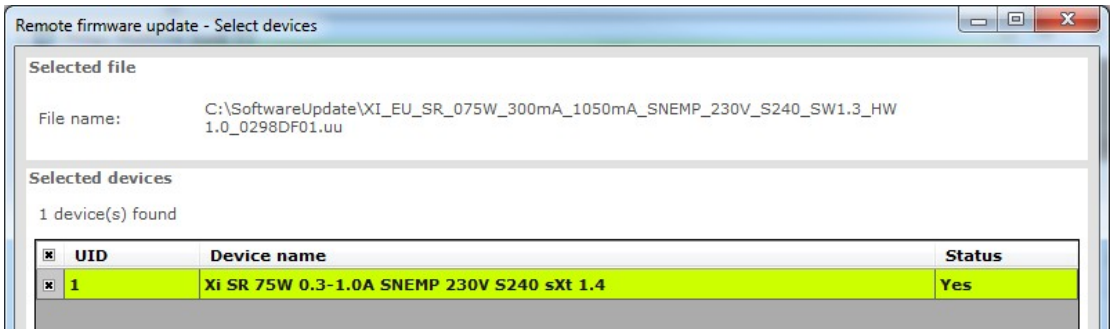

All supported devices for this update procedure are retrieved and listed. The status column describes the reason why a device is or isn't supported. The user can select the devices from the list and when one or more supported devices are selected the user can press **Start** to start the remote firmware update. During the update, the user can see the progress status, the different stages of the update and is able to abort the update procedure.

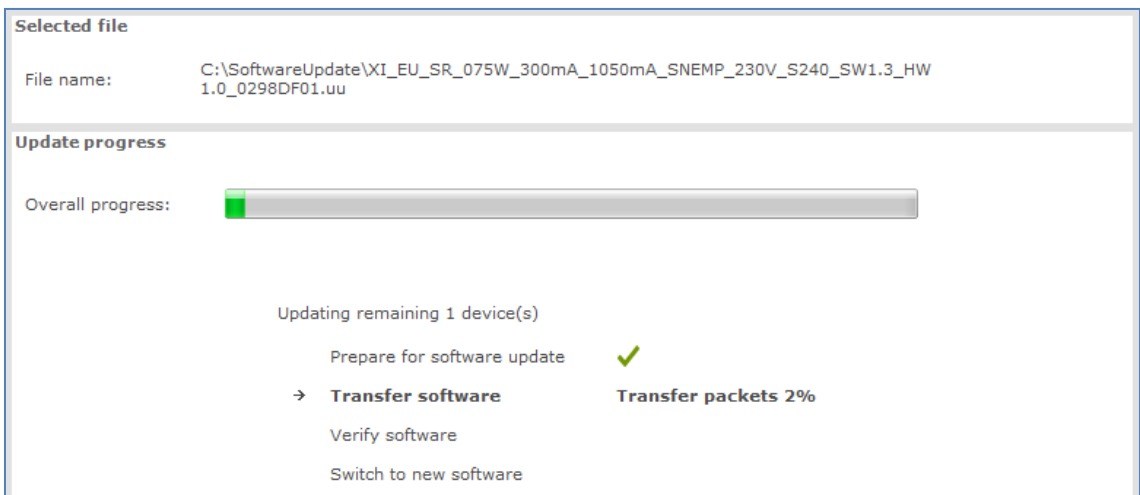

Once the update is finished, the final result is shown to the user in a simple overview.

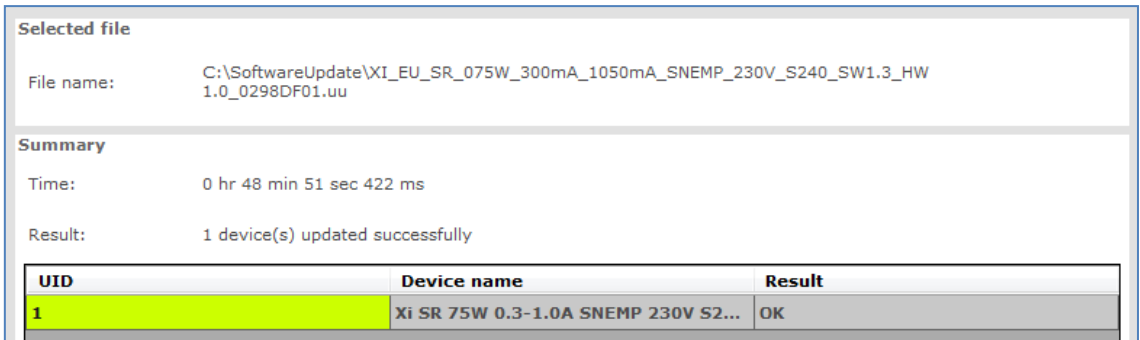

12.21 The logging window

The **logging window** shows the communication related to the features currently being read or written or when DALI commands are sent or received through the USB2DALI interface.

Timestamp	Address	Description	Result
29-3-2012 13:41:16	3	Constant Light Output: readin...	success
29-3-2012 13:41:16	3	Constant Light Output: readin...	success
29-3-2012 13:41:16	3	Adjustable Light Output: readi...	success
29-3-2012 13:41:14	3	AmplDim: reading values	success

Timestamp

The time the feature was read or written or the time the command was sent. The format of the timestamp is: <date> <time>.

Address

The short address to which the feature or command was sent. In case **Broadcast** is mentioned, all devices are addressed.

Description

The name of the feature or the actual DALI command.

Result

Result of the communication.

12.22 Setting preferences

MultiOne has a preferences window that allows you to customize the way MultiOne works. To access the preferences window select **Tools** → **Preferences**.

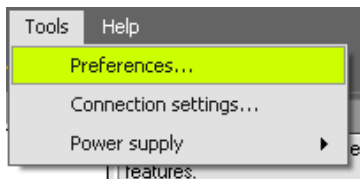





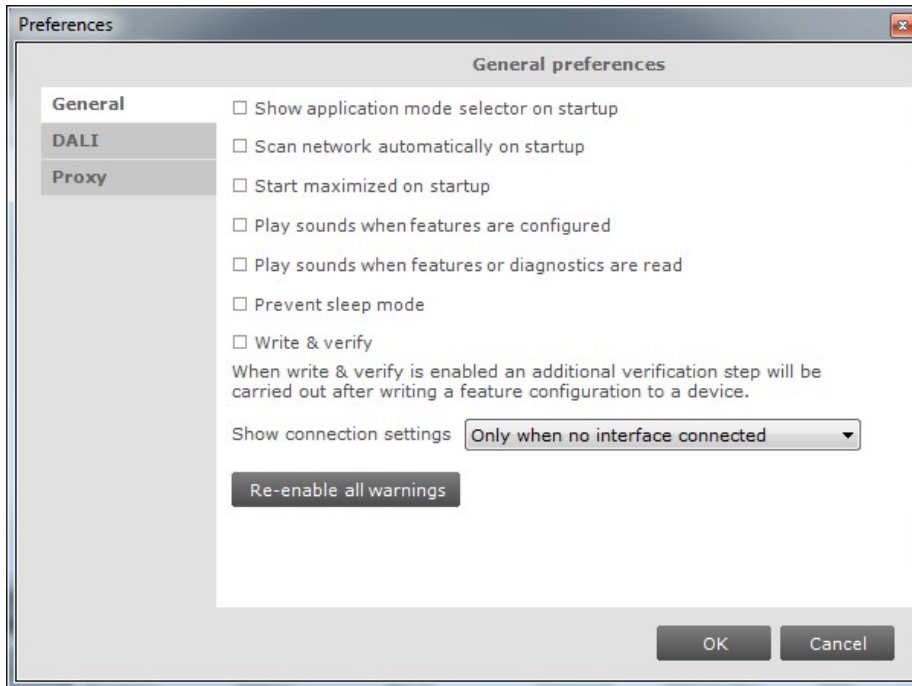

The **Preferences** window that pops up allows you to set MultiOne preferences.

12.22.1 General preferences



The following list summarizes the available preferences and gives an explanation for each.

- **Show application mode selector on startup.** When MultiOne is started you are presented with a screen that allows you choose an application mode, based on the tasks you would like to perform. You can disable this screen by clearing the **Show application mode selector on startup** check box. Changing this settings only takes effect once MultiOne is restarted.
- **Scan network automatically on startup.** By selecting this check box MultiOne will automatically initiate a network scan on startup. Changing this settings only takes effect once MultiOne is restarted.
- **Start maximized on startup.** By selecting this checkbox MultiOne will be started full screen. Changing this settings only takes effect once MultiOne is restarted.
- **Play sounds when features are configured.** When this check box is selected, MultiOne will make a sound when a feature configuration is (un)successfully written to a driver.
- **Play sounds when features, diagnostics or energy meter are read.** When this check box is selected, MultiOne will make a sound when a feature configuration is (un)successfully read from a driver, when energy meter or when diagnostics are (un)successfully read from a driver.

- **Prevent sleep mode.** By selecting this check box MultiOne will prevent the PC or laptop from automatically entering the sleep mode as long as MultiOne is active.
- **Write & verify.** By default, MultiOne will write parameters to the connected device(s) without checking the state of the device afterwards. By enabling **Write & verify** you force MultiOne to perform an additional verification step by reading back the written parameters immediately after writing. If the received values differ from the parameters that were written, MultiOne will alert you that there is a deviation between MultiOne and the device.
The **Write & verify** uses different status icons than **Write**. When a **Write & verify** action is successful the icon will be totally green . When the verify action has failed the entire icon will become red.  A pending action will be displayed as a grey icon.  It is also possible that a part of the **Write & verify** fails. To help indicate where the action failed, two extra icons exist. If the first half of the icon is red and the second part is grey,  then the write action failed. When the first part is green and the second part is red,  then the read action has failed. It is possible to have both the Write & verify as orange,  this means that the feature might not be configured correctly because the program could not verify the result.
- **Show connection settings.** Changing this setting allows you to control the appearance of Connection Settings window when MultiOne starts. The following options are possible:
 - Only when no interface connected:** Connection Settings window will be shown on startup only when there are no interfaces connected.
 - Always on startup:** Connection Settings window will always be shown on startup.
 - Never on startup:** Connection Settings window will never be shown on startup.
- **Re-enable all warnings.** MultiOne produces a number of warnings that you can disable by selecting their **Don't show this message again** check box. If you would like to reset all suppressed warnings click the **Re-enable all warnings** button.

12.22.2 DALI

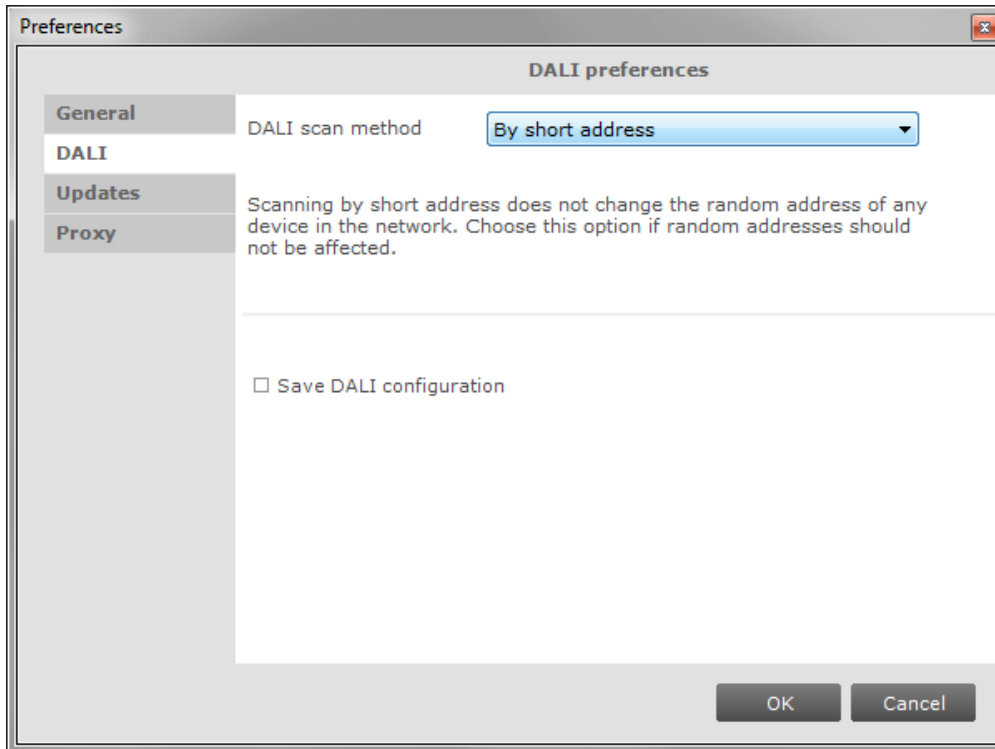

- **DALI scan method.** Changing this setting allows the user to control the way in which a DALI network is scanned. The following options are possible:
 - By short address:** DALI devices are scanned by their short address.
 - By random address:** DALI devices are scanned by their random address.
- **Save DALI configuration.** Checking this setting give the users the ability to save DALI settings when saving a feature file. By clearing this check box, the save DALI settings option will not appear when saving a feature file.

For more details on the DALI scan methods, see [Identifying devices](#).

12.22.3 Updates

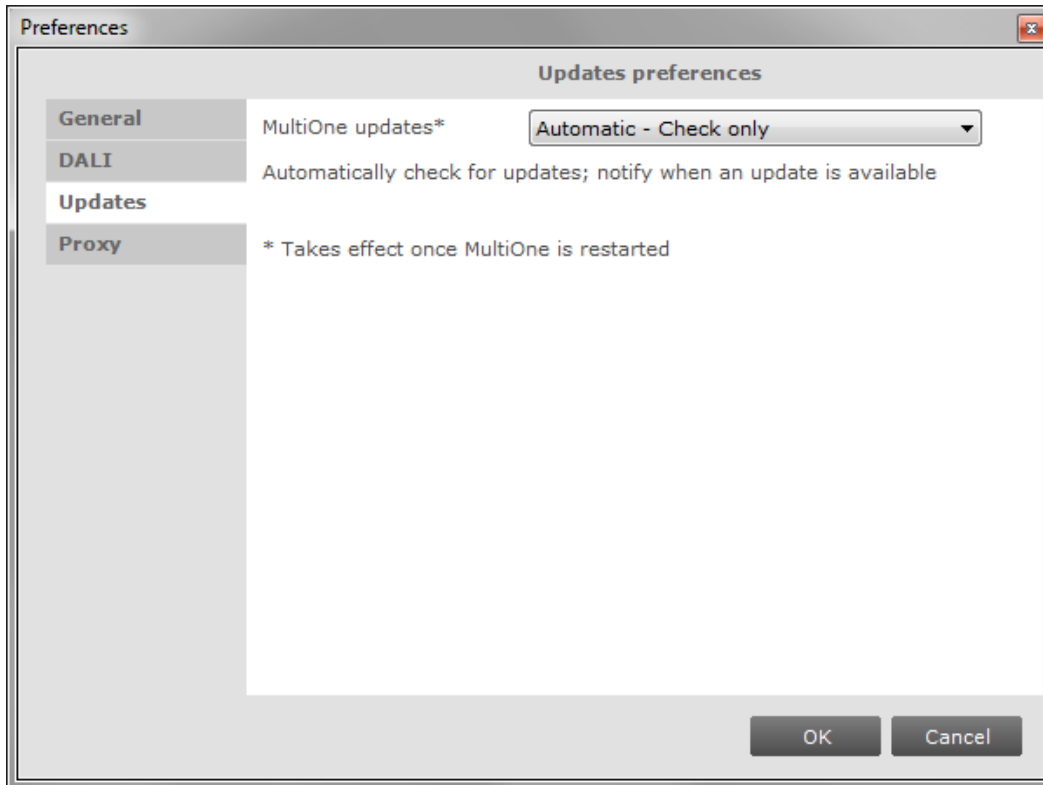

- **MultiOne updates.** Changing this setting allows the user to control the update method of MultiOne. The following options are possible:
 - Automatic – Check, download, install:** MultiOne will automatically check for updates and if available download and install them automatically.
 - Automatic – Check, download only:** MultiOne will automatically check for updates and if available download them. The user then has to agree to let MultiOne update itself.
 - Automatic - Check only:** MultiOne will automatically check for updates and notify the user if a new version is available. The user can then allow MultiOne to download and install the update.
 - Manual:** MultiOne will do nothing and the user has to force MultiOne to check, download and install any update.

12.22.4 Proxy

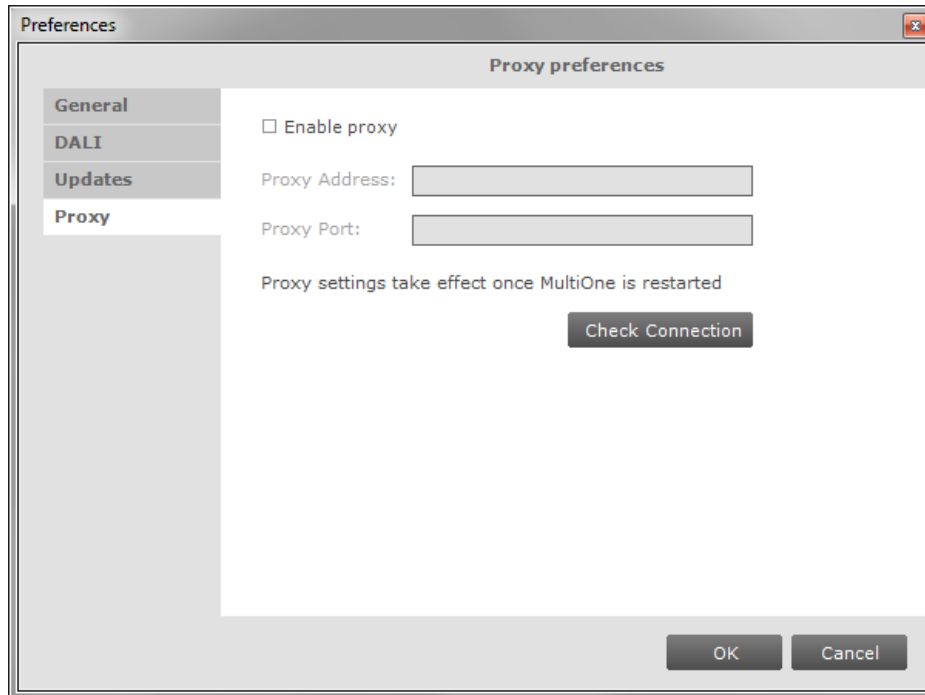

- **Proxy address**

The proxy address that needs to be used by MultiOne.

Examples:

1.1.1.1 or proxy.mycompany.com

http://1.1.1.1 or https://1.1.1.1

https://proxy.mycompany.com or https://proxy.mycompany.com

- **Proxy Port**

The port that needs to be used by MultiOne

Examples:

80, 8080, 8888

12.23 Manually selecting the USB2DALI interface

MultiOne will automatically detect the USB2DALI interface that is connected to the PC. However when multiple interfaces are connected it will use the interface on the port that is found first. It is possible to manually change the port that is used by selecting **Tools** → **Connection settings**.

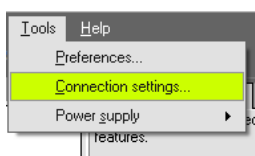

In the pop-up window it is then possible to select the desired port.

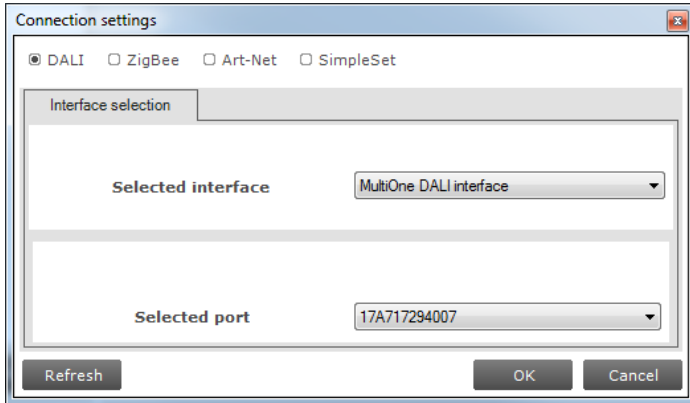

Notice! The unique id of the interface is shown at the port selection. This, to be able to identify which interface is used by which MultiOne instance (when configuring devices in parallel using multiple instances of MultiOne).

12.24 Enabling/Disabling the power supply of the USB2DALI interface

The USB2DALI interface will automatically detect if the DALI bus is powered by another device (for example a DALI power supply). If the DALI network is not powered, it will use its internal power supply.

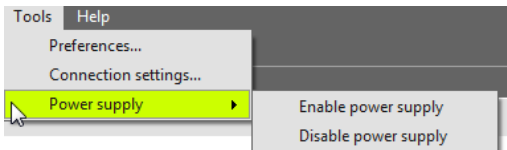

If, during operation, the DALI network is changed in a way that it requires the USB2DALI interface to switch on or off its internal power supply, you can do so using the option **Tools** → **Power supply**.

12.25 Supported features

The table below gives an overview of all features that are supported by MultiOne and to which product groups they apply.

Table 7 Supported features

Device feature	Product group				
	LED		HID	FLUO	CONTROL
	Indoor	Outdoor			
0-10V / 1-10V (SR bridge)					X
0-10V / 1-10V (LED driver)		X			
ActiLume General					X
ActiLume Mode					X
ActiLume Scene					X

Active Cooling	X			
Adjustable Light Output	X	X	X	
Adjustable Output Current	X	X		
Adjustable Output Current Multi-Channel	X	X		
Adjustable Startup Time		X		
AmpDim		X	X	
Auxiliary Power Supply Voltage	X			
Constant Light Output	X	X	X	
Constant Light Output Multi-Channel	X	X		
Coded Light	X			
Coded Light Randomize	X			
Coded Mains	X	X		
Coded Mains Standalone Receiver				X
Correlated Color Temperature Dual Channel	X	X		
Corridor Mode	X		X	
DALI 102	X	X		
DALI 202	X	X		
DALI Power Supply	X			
Daylight override / Daylight switching				X
Device Info		X		
Dimming Interface		X	X	
DiiA specification DALI Part 253 - Luminaire Maintenance				X
Driver addressing		X		
Driver Temperature Limit		X		
Driver Temperature Limit for Lock		X		
Dwell Time				X
Dynadimmer		X	X	
DC Emergency			X	
End Of Life indication		X		
FCC				X
FccRed				X

FlexTune	X	X		
Field Task Tuning				X
Field Task Tuning/ Occupancy Sensing / Daylight Harvesting				X
Lamp Burn-in				X
Lamp Selection			X	X
Light Source Operating Hours		X		
LineSwitch		X	X	
Load Fault Indicator Thresholds				X
Logical Signal Input	X			
Luminaire (Fixture) Information	X	X		
Luminaire Production Test				X
LumiStep		X		
Min Dim Level	X			
Motor Control				X
Module Temperature Protection	X	X		
NTC on LEDset	X	X		
Occupancy Sensing / sDaylight Harvesting				X
Occupancy sharing / Group light behavior				X
OEM Write Protection	X	X		
Push Button Unit LCU2070				X
Push Button Unit LCU2071				X
Quick Lamp Start				X
Relay Switched Output				X
Self Contained Emergency	X			
Set Lamp On Time	X			
SR Power Supply	X			
Step Dimming	X	X		
Summary	X	X	X	X
Touch and Dim	X			X
Tx Power				X

12.26 Device-specific technical descriptions

For a detailed technical description of the characteristics of the devices, please visit the product-specific web sites:

Table 8 Product-specific web sites

Product group	Visit:
LED	www.philips.com/Xitanium
HID	www.philips.com/Xtreme
FLUO	www.philips.com/HFR-Intelligent
CONTROL	www.philips.com/Actilume

12.27 Error handling

12.27.1 Reporting and correction of errors/warnings when reading from a feature configuration file

When, after opening a feature configuration file, incorrect parameters are detected, MultiOne tries to correct these parameters for the selected (virtual) device. When a correction is made, a red border will be shown. In cases when no logical correction can be made, an orange border will be shown.

12.27.2 Reporting of errors when reading from a device

When after reading from a device a mismatch is signaled between the parameters of the device and MultiOne, MultiOne will not correct the parameters, but will show a red border.

12.27.3 Reporting of errors when entering incorrect values in a feature

Entering an incorrect value for a parameter will be indicated by a red border.

12.28 Troubleshooting

Problem: After starting MultiOne, no devices are displayed.

Solution: Click the **Scan network** button on the **Network** panel to start discovering the devices in the network. If the devices connected have already a DALI short address this will not be changed. Devices without a short address will be programmed with a short address. When the **Commission** button is clicked, the short addresses of all connected devices will be renewed, whether they already had a short address or not.

Problem: I would like to assign a specific short address to a device.

Solution: First scan the network for devices. Right-click the device you would like to give a short address and select **Set short address**.

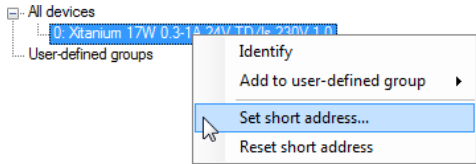

A dialog window will appear in which you can enter the desired short address.

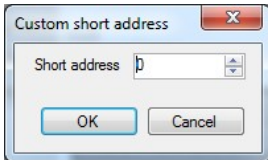

Click **OK** to program the short address into the device.

Problem: I would like to remove the short address of a device.

Solution: First scan the network for devices. Right-click the device whose short address you would like to remove and select **Reset short address**.

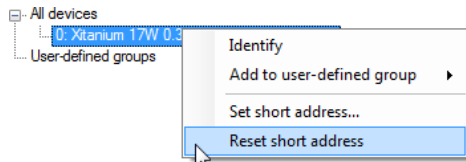

You will be informed that the short address was reset.

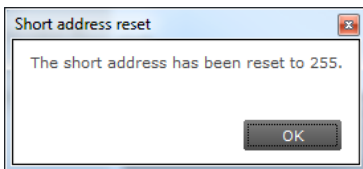

Problem: I would like to configure the special features of the connected device.

Solution: After scanning the network for devices, a device has to be selected by clicking it in the **Network**. Select the **Device features** tab. The related features will appear. To update the view to the actual status of the features, click **Read** on the toolbar. If you now change any of the features, and want this to be stored into the device, click **Write** on the toolbar.

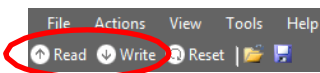

Problem: I would like to know more technical details of a device.

Solution: Please refer to the website for more detailed information

13 Keyboard shortcuts

Keyboard shortcuts can make it easier to work with MultiOne without using the mouse.

Table 9 Keyboard shortcuts

	USB2DALI interface	USB2ZigBee interface
The File menu	Working with feature configuration files	
Ctrl+O	Open a feature configuration file	Not supported
Ctrl+S	Save a feature configuration file (Save)	Not supported
Ctrl+Shift+S	Save a feature configuration file (Save As)	Not supported
Alt+F4	Exit MultiOne	
The Action menu	Working with devices	
Ctrl+D	Scan network	Scan area
Ctrl+Q	Commission	Not supported
Ctrl+R	Read from current device	Not supported
Ctrl+W	Write to current device	Not supported
The Tools menu		
Ctrl+M	Open the Application mode selector	
The Help menu		
Shift+F1	Open the Getting started document	
F1	Open the User manual	

14 Software Update

MultiOne has the possibility to update itself to a newer version. This can be done either automatically or manually and can be set in the preference window, see the Setting Preferences for more info.

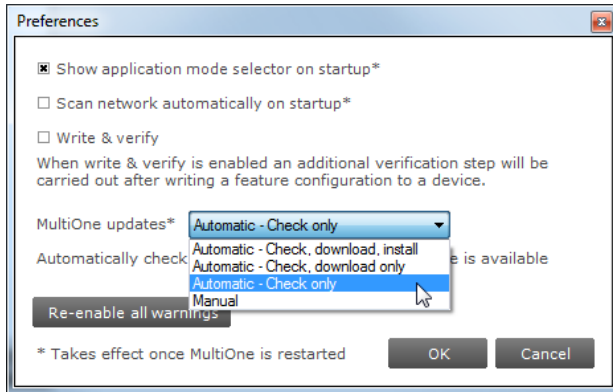

If the preference is set to Manual then the user can check for an update on MultiOne by selecting **Help** → **Check for updates** option.

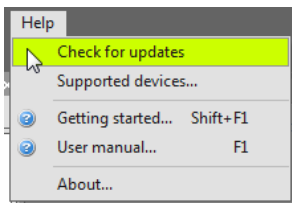

After a manual update check, or by using the automatic options, the update status near the **Help** menu will show if a new version is available. The user can then decide to continue downloading/updating by either using the update status or the **Help** menu to carry on.

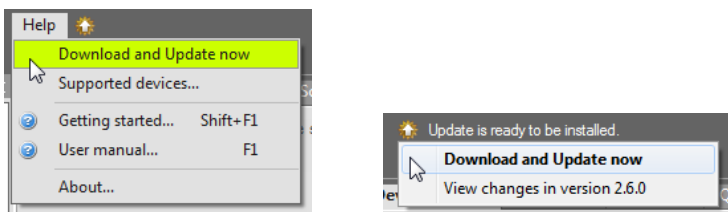

After downloading the update status will inform the user to restart to continue.

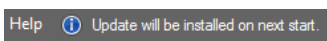

Restarting MultiOne will install the update.

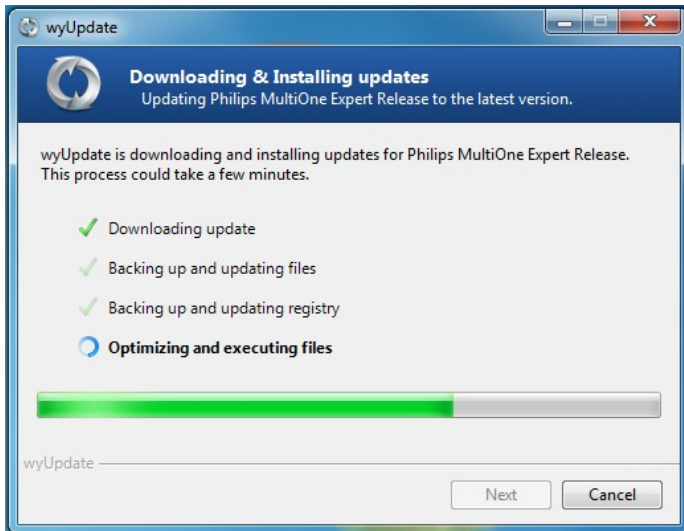

A successful update of MultiOne will be shown in the update status.

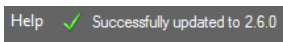

15 Copyright

© 2021 Signify Holding. All rights reserved.

All rights reserved. No part of this publication may be reproduced, transmitted, transcribed, stored in a retrieval system or translated into any language or computer language, in any form or by any means, electronic, mechanical, magnetic, optical, chemical, manual or otherwise, without prior written permission from Signify. Brands and product names are trademarks or registered trademarks of their respective companies.

16 Disclaimer

Signify makes no warranty of any kind with regard to this material, including, but not limited to, the implied warranties of merchantability and fitness for a particular purpose.

Signify assumes no responsibility for any error that may appear in this document. Signify makes no commitment to update nor to keep current the information contained in this document.

17 Limitations of damages

The vendor will not be liable for any indirect, special, incidental or consequential damages (including damages for loss of business, loss of profits, or the like), whether based on breach of contract, tort (including negligence), product liability or otherwise, even if the vendor or its representatives have been advised of the possibility of such damages and even if a remedy set forth herein is found to have failed its essential purpose.

18 List of tables

Table 1 HID diagnostics.....	107
Table 2 LED diagnostics.....	109
Table 3 Subset of LED diagnostics.....	111
Table 4 Motor control diagnostics	112
Table 5 Emergency diagnostics	113
Table 6 DiiA diagnostics.....	114
Table 7 Supported features	131
Table 8 Product-specific web sites.....	134
Table 9 Keyboard shortcuts	136

19 Index

0-10V / 1-10V (LED driver)	42, 131
0-10V / 1-10V (SR bridge)	41, 131
ActiLume General	43, 131
ActiLume Mode	44, 45, 131
ActiLume Scene	46, 131
Active Cooling	46, 132
Adjustable Light Output	47, 132
Adjustable Output Current	48, 55, 132
Adjustable Output Current Multi-Channel	48, 55, 132
Adjustable Startup Time	49, 111, 132
AmpDim	49, 63, 132
Auxiliary Power Supply Voltage	50, 132
Coded Light On and Off	50, 132
Coded Light Randomize	119, 132
Coded Mains	50, 52, 63, 132
Coded Mains Standalone Receiver	52, 132
Constant Light Output	52, 54, 55, 68, 75, 109, 132
Constant Light Output Multi-Channel	55, 132
Correlated Color Temperature Dual Channel	56, 132
Corridor Mode	51, 57, 58, 59, 132
DALI 102	58, 132
DALI 202	59, 132
DALI Power Supply	60, 132
Daylight override / Daylight switching	60, 132
DC Emergency	61, 132
Device Info	61, 62, 132
Diagnostics	36, 106, 107, 109, 113, 114
DiiA specification DALI Part 252 - Energy reporting	118
DiiA specification DALI Part 253 - Diagnostics	114
DiiA specification DALI Part 253 - Luminaire Maintenance	62, 132
Dimming Interface	62, 63, 132
Driver addressing	64, 132
Driver Temperature Limit	64, 65, 132
Driver Temperature Limit for Lock	65, 66, 132
Dwell Time	66, 132
Dynadimmer	63, 66, 81, 132
End Of Life indication	68, 75, 132
Energy Meter	36, 117, 118
FCC	69, 70, 132
FccRed	70, 132

Field Task Tuning 72, 73, 133

Field Task Tuning/ Occupancy Sensing / Daylight Harvesting.....	133
FlexTune	71, 72, 133
Lamp Burn-in.....	74, 133
Lamp Selection	68, 74, 133
Light Source Operating Hours	68, 75, 133
LineSwitch.....	63, 75, 76, 133
Load Fault Indicator Thresholds	77, 133
Logical Signal Input	78, 133
Luminaire (Fixture) Information.....	79, 80, 133
Luminaire Production Test	80, 133
LumiStep	81, 133
Min Dim Level	82, 133
Module Temperature Protection.....	84, 110, 133
Motor Control.....	83, 133
NTC on LEDset.....	85, 133
Occupancy Sensing / Daylight Harvesting	60, 73, 86, 133
Occupancy sharing / Group light behavior	87, 133
OEM Write Protection	87, 133
Push Button Unit LCU2070.....	88, 89, 133
Push Button Unit LCU2071	89, 133
Quick Lamp Start	89, 92, 133
Relay Switched Output	90, 133
Self Contained Emergency	90, 133
Set Lamp On Time	116, 133
SR Power Supply	60, 91, 133
Step Dimming	92, 133
Touch and Dim	57, 92, 97, 133
Tx Power.....	93, 133