

Dismantling Recommendation on Disposal at End of Life

Composition Explanation

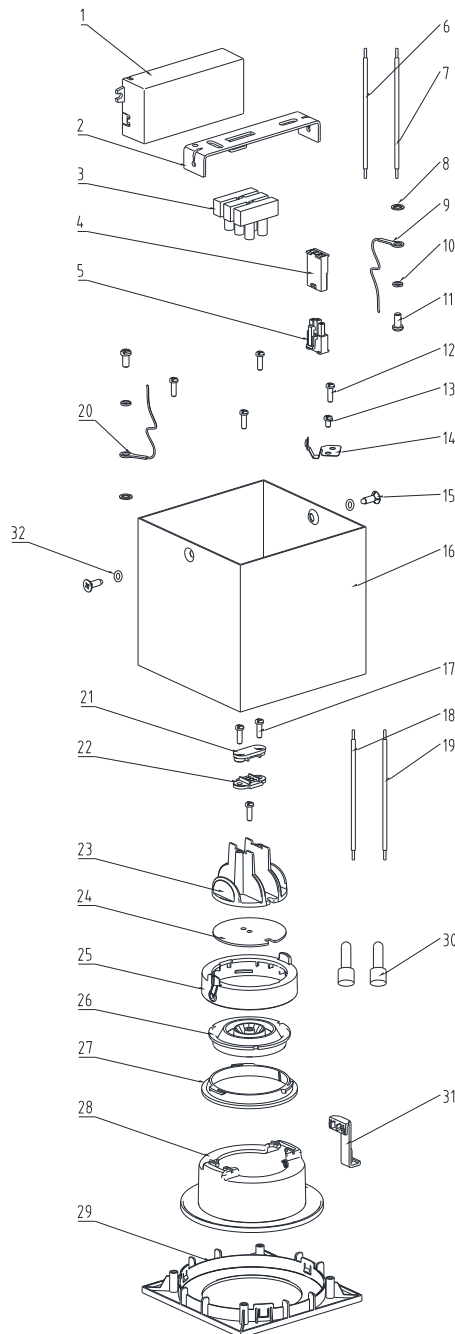

Dismantling Recommendation on Disposal at End of Life

Composition Explanation

No.	Components	Specifications	Unit	Quantity
1	PYS 5W driver		PCS	1
2	G17516 bracket	Zinc coated	PCS	1
3	T06-3P		PCS	1
4	5557-3P	PA	PCS	1
5	5559-3R	PA	PCS	1
6	VDE brown wire	VDE 0.5mm ²	PCS	1
7	VDE blue wire	VDE 0.5mm ²	PCS	1
8	φ4 teeth washer	Zinc coated	PCS	2
9	Earthing wire	UL 1332 20AWG	PCS	1
10	φ4 spring washer	Zinc coated	PCS	2
11	M4*6mm screw	Copper coated	PCS	2
12	BT3*8 screw	Zinc coated	PCS	5
13	M3*5mm screw	Zinc coated	PCS	1
14	G17516 limiter		PCS	1
15	M4*12 screw	Zinc coated	PCS	2
16	G17516 body	Metal sheet, T=1mm	PCS	1
17	M3*10mm screw	Zinc coated	PCS	2
18	FEP red wire	UL 1332/22AWG	PCS	1
19	FEP black wire	UL 1332/22AWG	PCS	1
20	Earthing wire	UL 1332 20AWG	PCS	1
21	G17516 upper strain relief	PA6	PCS	1
22	G17516 lower strain relief	PA6	PCS	1
23	G17516 heat sink	ADC12	PCS	1
24	YL20-7-14DB4W-C017		PCS	1
25	G17516 heead	ABS	PCS	1
26	G17516 lens	PC	PCS	1
27	G17516 ring	ABS	PCS	1
28	G17516 head holder	ABS	PCS	1
29	G17516 cover	ABS	PCS	1
30	Closed end connector		PCS	2
31	G17516 plastic limiter	ABS	PCS	1
32	φ4 teeth washer	SS	PCS	2

Dismantling Recommendation on Disposal at End of Life

Dismantling

- Type: Without permanent damage

Recommendation on Disposal

- Plastic part: Reuse and Recycling
- Electrical part: Incineration and disposal
- Metal part: Recycling

Light source dismantling process

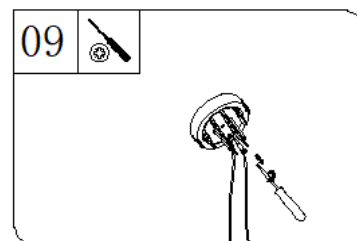
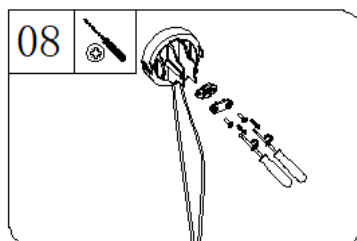
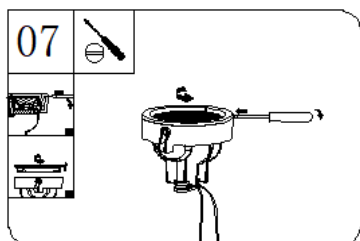
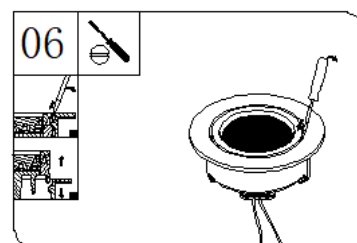
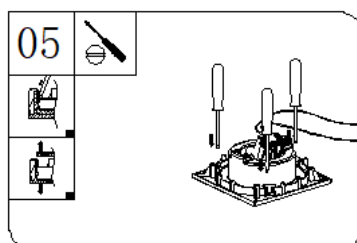
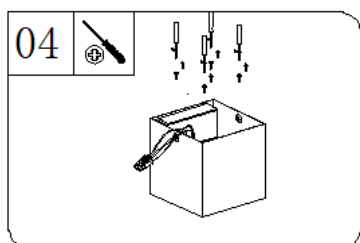
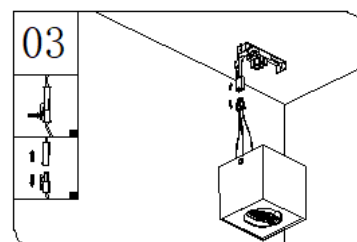
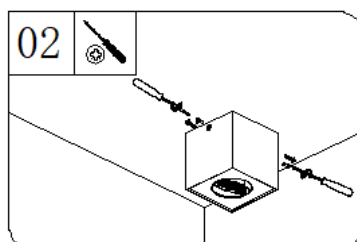
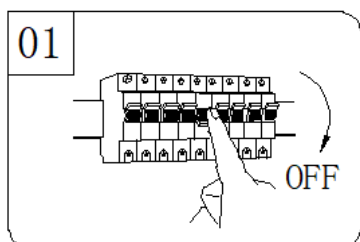

Dismantling Recommendation on Disposal at End of Life

