

PHILIPS

Capricorn
Ultra Efficient
9290047556

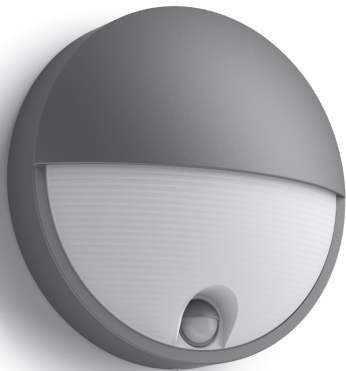

User manual
Benutzerhandbuch
Notice d'emploi
Manual de usuario
Manual do usuário
Manuale d'uso
Gebruiksaanwijzing

Incl.

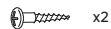
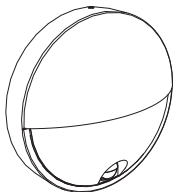

ST4.2*30mm

Excl.

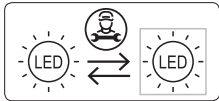
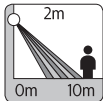
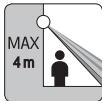
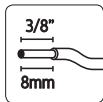
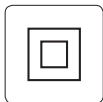
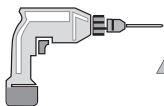

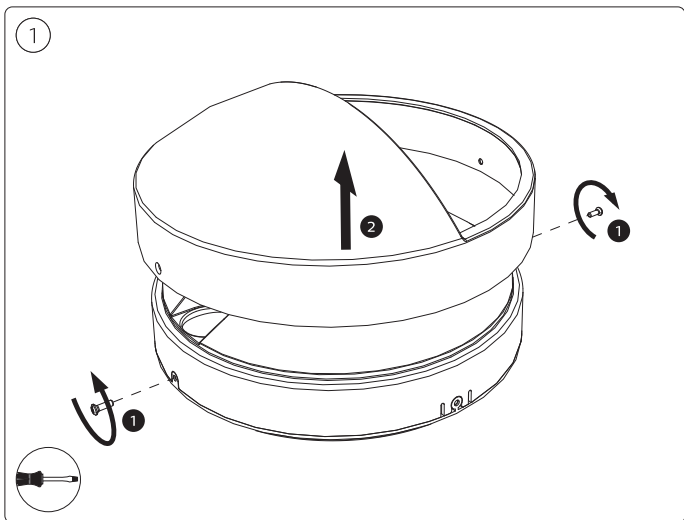
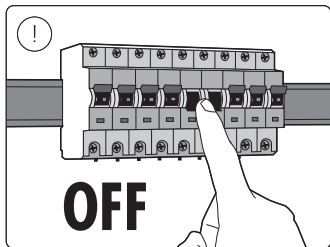
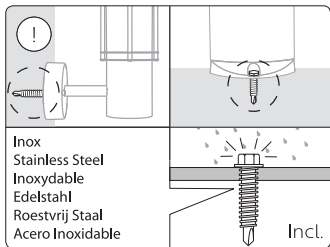

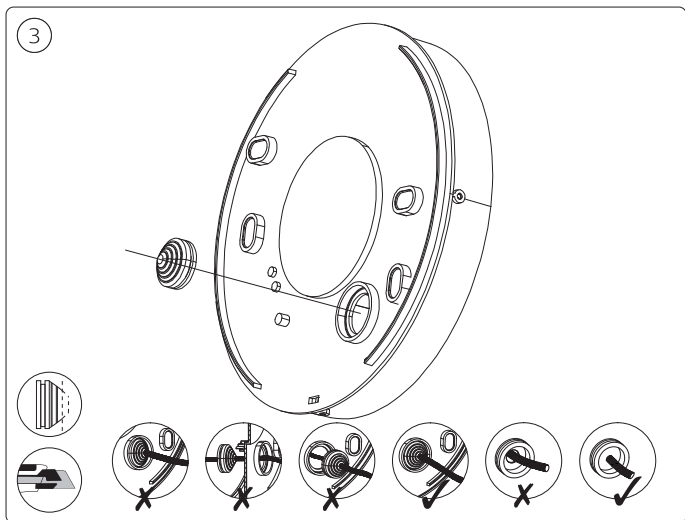
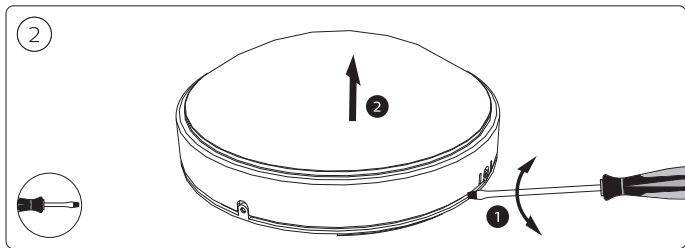

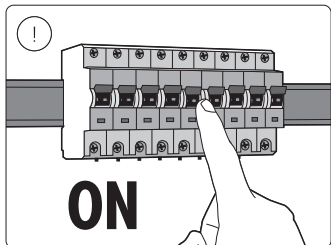
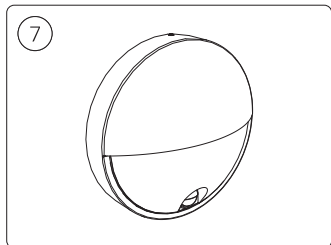
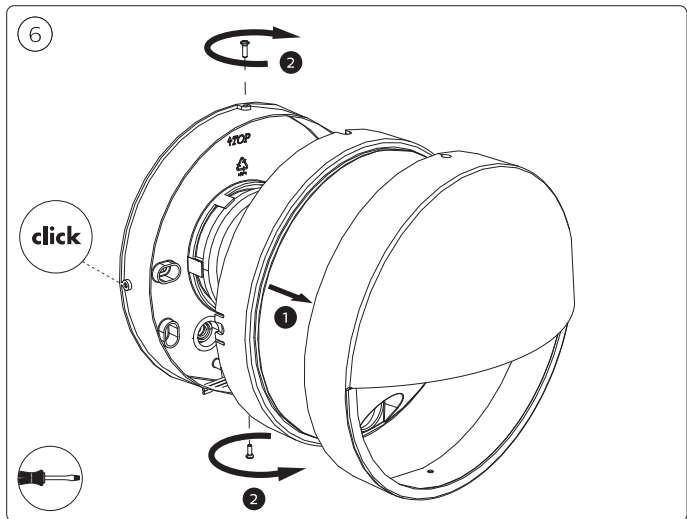

8a

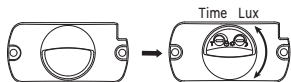

8b Time



5 Sec \pm 2 Sec



12 Min \pm 3 Min



8c Lux

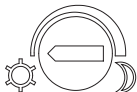

< 200Lux



< 30Lux





Signify Commercial UK Limited
2 Guildford Business Park,
GU2 8XG

Signify
I.B.R.S. / C.C.R.I. Numéro 10461
5600 VB Eindhoven,
the Netherlands
☎00800-74454775

© 2025 Signify Holding



3241 663 15821

Philips and the Philips Shield Emblem
are registered trademarks of Koninklijke
Philips N.V. and are used under license

www.philips.com/lighting