



Product information

This Manual and self-test 2 in 1 emergency module (EM) can be used built-in for the LED linear luminaires with intergrated LEDs. It is designed for installing within the fitting to provide a battery back-up supply in the event of a power cut.

The emergency module requires a permanent live un-switched supply to maintain the battery charge. In the event of a power cut the battery will supply the luminaire at a reduced output.



Automatic Self-Test technology that will perform regular automatic function and duration tests as required by EN 62034, reporting the results via a bi-coloured LED indicator.

Emergency Unit	12NC	Technology	Capacity	Power	Duration	Nominal voltage	Warranty of the kit	Warranty of battery
EM300V ELB_P3 kit HV 6.4V 2000mAh LFP v2	912401483668	Lithium iron phosphate	2000mAh	2.5W	3H	6.4V	3 years	3 years

Dimensions

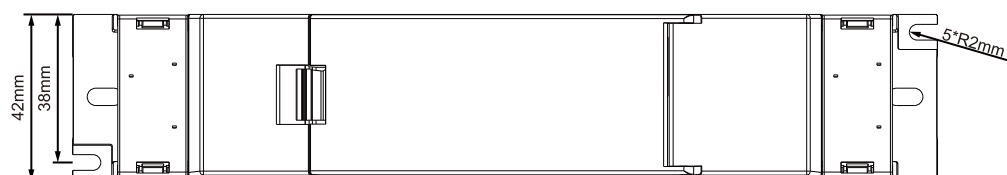
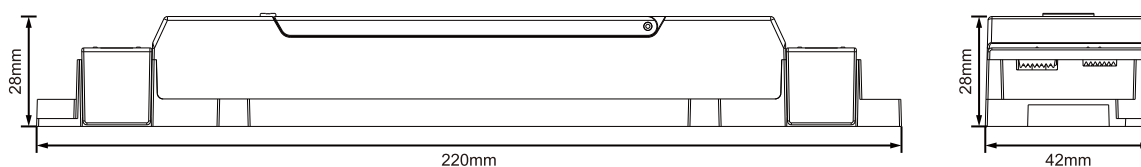

LED driver input cable

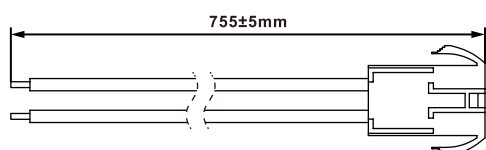

LED driver output cable

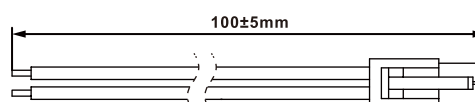

Main supply input cable

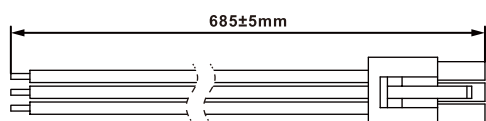

LED supply cable

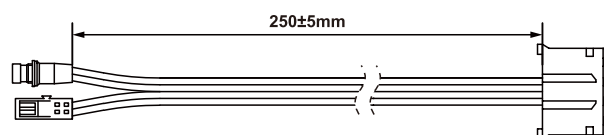
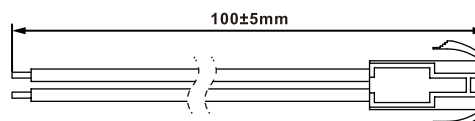

Test button cable

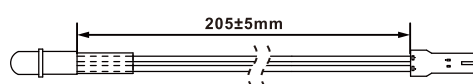

Standard indicator cable

Indicator holder

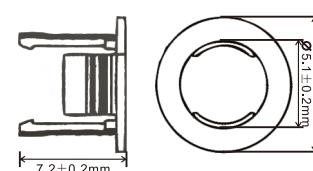

Installation of Emergency unit

1 Labels

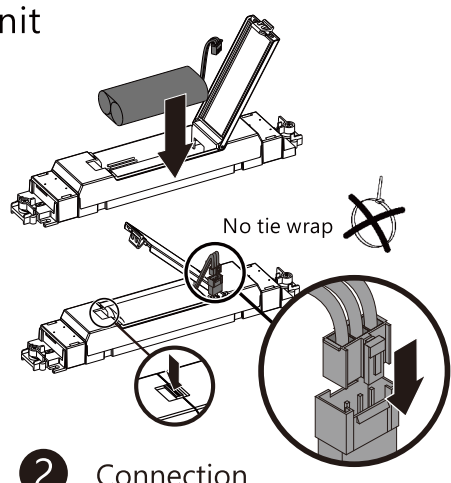
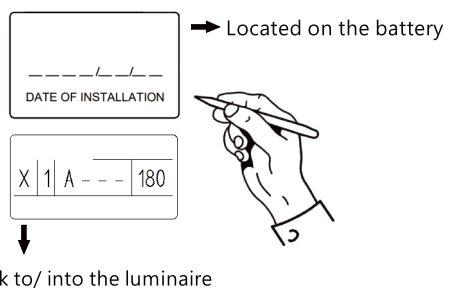

3 Log book

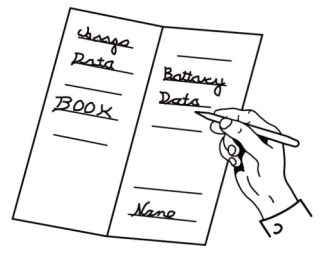

2 Connection

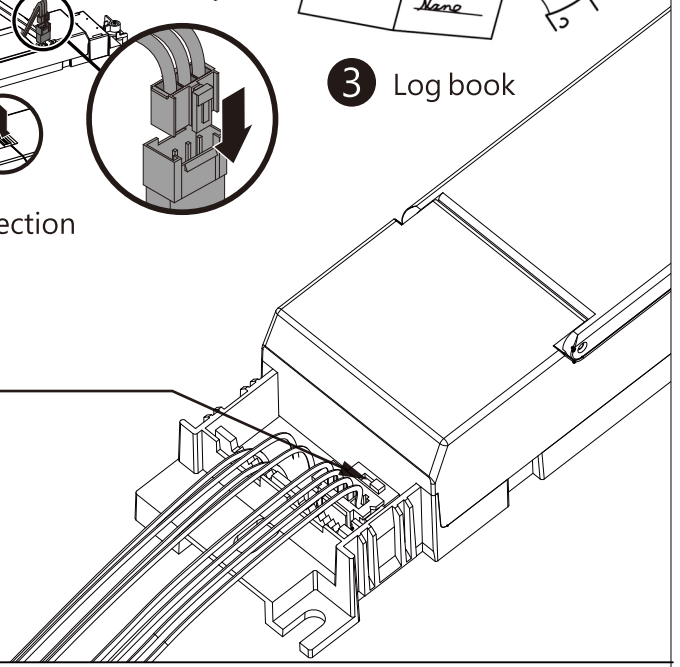
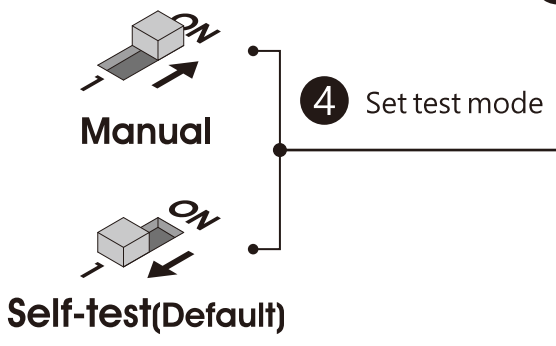

Emergency wiring

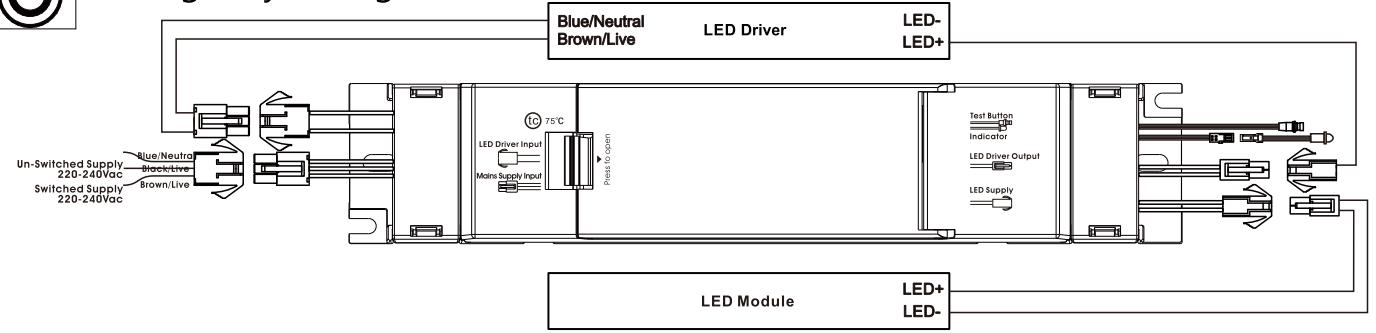

Charge time

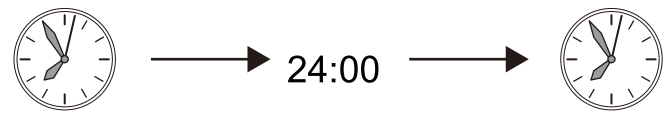

Test high voltage max. 500V

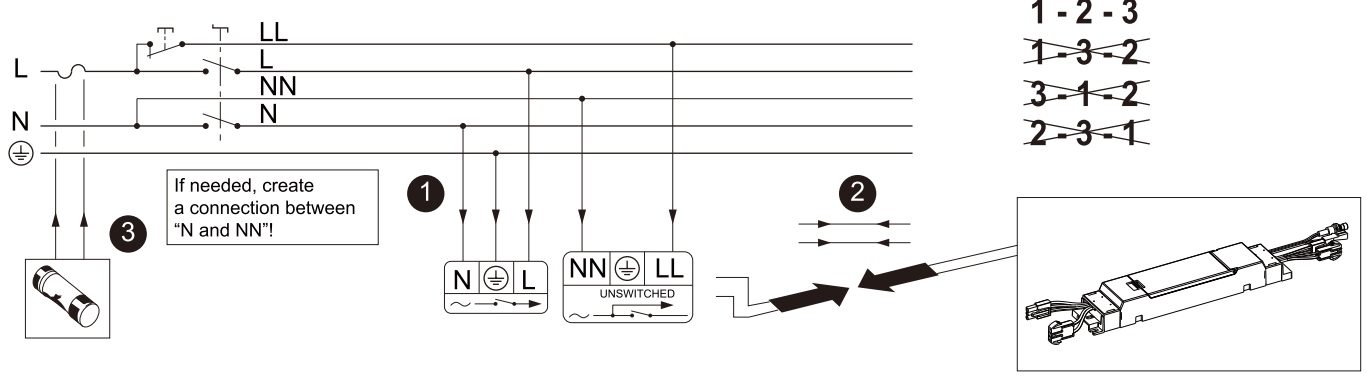



Self-Test Mode: Automatic / Manual Testing User Guide

Commissioning

Commissioning takes place by connecting the battery and then the un-switched supply. The battery must be connected first. The green LED will immediately flash 1 x second to indicate that there is a pending duration test.

A functional test will occur at 5 minutes after commissioning to allow 5 minutes for battery charging to ensure there is some charge in the battery.

A duration test will occur at a random point between 24 hours and 48 hours after commissioning to allow 24 hours for battery charging.

Any faults found in the functional and duration testing will be reported via the LED indicator, as detailed below.

Disconnecting the un-switched supply and then the battery resets the emergency module, clears all fault reports and forces a re-commission when the battery and then the un-switched supply are reconnected.

If the un-switched supply of an emergency lighting circuit is switched OFF/ON twice within 5 seconds, the schedule for all the emergency units in the emergency lighting circuit is reset (to the current time).

Duration Testing (3 hours)

An automatic duration test will occur at a random point between 24 hours and 48 hours after commissioning to allow for battery charging.

An automatic duration test will occur semi-annually or annually at a random point in the 26th or 52nd week of each year.

A duration test will occur once the battery is fully charged after pressing the manual test button for 5-10 seconds.

A duration test may be delayed by other events, such as a power cut that interrupts the test or a lack of charging time, in which case the green LED will flash 1 x second to indicate there is a pending duration test that the emergency module has rescheduled.

Any faults found in the duration testing will be reported via the LED indicator, as detailed below.

A functional test will not override any faults reported by a duration test. A full duration test or re-commissioning is required to clear any faults.

Functional Testing (<2 minutes)

A 5 seconds automatic functional test will occur at 5 minutes after commissioning.

A 108 seconds automatic functional test will occur every 7 days.

A manual 108 seconds functional test will start immediately after pressing the manual test button for 1-2 seconds.

Any faults found in the functional testing will be reported via the LED indicator, as detailed below.

A functional test will not override any faults reported by a duration test. A full duration test or re-commissioning is required to clear any faults.

Manual Testing

Manual functional test: Press the manual test button for 1-2 seconds. A manual functional test lasting <2 minutes will start immediately.

Manual duration test: Press the manual test button for 5-10 seconds. A manual duration test will occur once the battery is fully charged after pressing the manual test button for 5-10 seconds.

Pending Duration Testing

A duration test may be delayed by other events, such as a power cut that interrupts the test or charging period, in which case the green LED will flash to indicate there is a pending duration test that the emergency module has rescheduled until charging is complete.

Lamp or Luminaire Fault

Turn off the supply and replace or correct the fault with the lamp or luminaire, and then reconnect the supply.

Press the manual test button for 5-10 seconds. A manual duration test will occur once the battery is fully charged.

If the battery and power have been disconnected the EM will re-commission and automatically test the replacement.

A successful functional test will not override any faults reported by a duration test. A full duration test or re-commissioning is required to clear fault reports.

Battery Fault

Turn off the un-switched supply to the EM and replace the battery, and then reconnect the supply.

If the fault was because the battery was not connected, the un-switched supply must still be turned off when connecting the battery to clear the battery fault.

The EM will re-commission and so automatically test the replacement at a random point between 24 and 48 hours after commissioning to allow for battery charging.



Manual Mode: Manual Testing User Guide

The battery leaves the factory in a semi-charged state but may take up to 24 hours to fully charge for a 3-hour test. Charge for 5 minutes before performing a functional test to ensure there is some charge in the battery.

A quick functional test can be performed by pressing the test button for 1-2 seconds.

To fully test the emergency function, the un-switched supply will need to be turned off. Alternatively press the manual test button for 5-10 seconds. A manual duration test will occur once the battery is fully charged. A duration test may be delayed by a lack of charging time, in which case the green LED will flash 1 x second to indicate there is a pending duration test that the emergency module has rescheduled.

Any faults found in the functional and duration test will be reported via the LED indicator, as detailed below.

Disconnecting the un-switched supply and then the battery resets the emergency module, clears all fault reports when the battery and then the un-switched supply are reconnected.

Replace the battery when the luminaire fails to meet the 3-hour duration requirement in testing. Press the manual test button for 5-10 seconds. A manual duration test will occur once the battery is fully charged.

Replace or correct the fault with the lamp or luminaire, and then reconnect the supply. Press the manual test button for 1-2s seconds. A manual functional test lasting <2 minutes will start immediately.

Preiodic tests must be performed according to EN50172:2004m clause 7.2.3 and 7.2.4.

The tests could be done by complete disconnection of the luminaire.





















Lifetime

The batteries have a life time expectancy of 3 years when maintained properly.

The emergency unit should be replaced when it no longer meets the rated duration of operation after the corresponding recharge period.







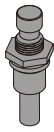
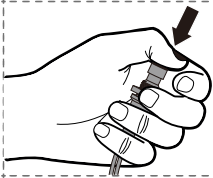

LED Indicator

System status is locally indicated by a bi-coloured LED indicator.

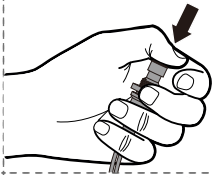
LED indication		Description	Status	Manual Mode	Self-test Mode
		Green Permanently On	System Healthy	✓	✓
		Permanently OFF	Emergency Mode: Mains failure or mains disconnected	✓	✓
		Green Slow Flash (0.5s on-0.5s off)	Duration Test Pending	✓	✓
		Green Medium Flash (0.25s on-0.25s off)	Duration Test Running	✓	✓
		Green Fast Flash (0.125s on-0.125s off)	Functional Test Running	✓	✓
		Red Permanently On	Battery Charging Fault	✓	✓
		Red Medium Flash (0.25s on-0.25s off)	Battery Duration Fault	✓	✓
		Red Fast Flash (0.125s on-0.125s off)	Lamp or Luminaire Fault	✓	✓
		OFF 1s then Red Stay On 5s	26 Weeks Duration Test Interval	N/A	✓
		OFF 1s then Red Fast Flash 5s (0.125s on-0.125s off)	52 Weeks Duration Test Interval	N/A	✓

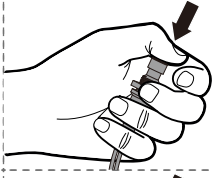
Functionality of the test button

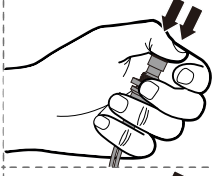
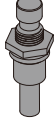
The test button enables you to make a series of settings manually.

Test button	Description	Function	Manual Mode	Self-test Mode
 	Press 1-2s	Manual functional test	✓	✓
 	Press 5-10s	Manual duration test	✓	✓
 	Press <1s	Confirm the current duration test interval	N/A	✓
 	Double press <1s	Set the duration test interval	N/A	✓
 	Double press <1s during emergency mode	Rest mode activated	✓	✓



© 2024 Signify Holding

All rights reserved. This document contains information relating to the product portfolio of Signify which information may be subject to change. No representation or warranty as to the accuracy or completeness of the information included herein is given and any liability for any action in reliance thereon is disclaimed. The information presented in this document is not intended as any commercial offer and does not form part of any quotation or contract. Philips and the Philips Shield Emblem are registered trademarks of Koninklijke Philips N.V.. All other trademarks are owned by Signify Holding or their respective owners.

Signify Holding
The Netherlands